



KWAZULU-NATAL PROVINCE

TRANSPORT
REPUBLIC OF SOUTH AFRICA

CONTRACT NO. ZNB01307/00000/00/POR/INF/22/T: PROVISION OF MAINTENANCE ON VARIOUS PROVINCIAL ROADS OVER A PERIOD OF 36 MONTHS WITHIN UMZUMBE SOUTHERN ZONE 1 UNDER COST CENTRE PORT SHEPSTONE IN THE DURBAN REGION.

CIDB GRADE 8 CE OR HIGHER

Name of Tenderer:
.....

This tender closes at **11h00 on Monday, 22 April 2024** at the offices of the Department of Transport located at 04 Aubrey Road, Westmead, Pinetown, 3610

LATE SUBMISSIONS WILL NOT BE CONSIDERED

Issued by:

The Department of Transport
04 Aubrey Road
Westmead, Pinetown
3610

Contact Name: Mr Nad Govender
Telephone: 031 700 2222

Prepared by:

The Department of Transport
05 Memorial Road
Port Shepstone
4240

Contact Name: Mr Moahloli Makoro
Telephone: 039 688 4340



PROVINCE OF KWAZULU-NATAL
DEPARTMENT OF TRANSPORT

CONTRACT NO. ZNB01307/00000/00/POR/INF/22/T: PROVISION OF MAINTENANCE ON VARIOUS PROVINCIAL ROADS OVER A PERIOD OF 36 MONTHS WITHIN UMZUMBE SOUTHERN ZONE 1 UNDER COST CENTRE PORT SHEPSTONE IN THE DURBAN REGION.

Tender section of document: Pages T1 – T51
Contract section of document: Pages C1 – C246

CONTENTS

Section number and heading	Page Colours
The Tender	
Part T1: Tendering procedures	
T1.1 Tender Notice and Invitation to Tender	White
T1.2 Tender Data	Pink
Part T2: Returnable documents	
T2.1 List of Returnable Documents	Yellow
T2.2 Returnable Schedules	Yellow
The Contract	
Part C1: Agreements and Contract Data	
C1.1 Form of Offer and Acceptance	Yellow
C1.2 Contract Data	Yellow
C1.3 Performance Guarantee	White
C1.4 Agreement in terms of Section 37(2) of the Occupational Health and Safety Act No. 85 of 1993	White
C1.5 Retention Money Guarantee	White
C1.6 Transfer of Rights	White
Part C2: Pricing Data	
C2.1 Pricing Assumptions	Yellow
C2.2 Bill of Quantities	Yellow
Part C3: Scope of Work	
C3.1 Standard Specifications	Blue
C3.2 Project Specifications	Blue
C3.3 Particular Specifications	Blue
Part C4: Site Information	
C4.1 Locality Plan	Green
C4.2 Example of Contract Signboard Details	Green
C4.3 Existing Services Report	Green
C4.4 Conditions on Site: Materials Information	Green
C4.5 Traffic Information	Green
C4.6 Standard Details	Green
C4.7 Any Other Relevant Technical Reports	Green

DOCUMENT CHECKLIST

This document checklist is provided to assist the Tenderer.

	ITEMS	CHECKED
1	Returnable Schedules in Section T2.2	<input type="checkbox"/>
2	Correct Tender Offer carried forward to C1.1 Form of Offer and Acceptance and the Form of Offer duly completed and signed.....	<input type="checkbox"/>
3	Bill of Quantities:	
	i) Completed in legible INK only.....	<input type="checkbox"/>
	ii) Corrections crossed out and initialled	<input type="checkbox"/>
4	Contract specific data provided by the Contractor	<input type="checkbox"/>

PART T1: TENDERING PROCEDURES

TABLE OF CONTENTS

T1.1	TENDER NOTICE AND INVITATION TO TENDER	T5
T1.2	TENDER DATA	T7

PLEASE NOTE:

Any appeals regarding the award of this bid should be lodged within 5 working days from the date of the publication of bid results which is published every week on Friday and may be downloaded from the website , [e-tenderportal /www.kzntransport.gov.za](http://e-tenderportal/www.kzntransport.gov.za), (select platforms that is available for publication)

The publication is also published in the following platforms, www.tenderbulletin.gov.za www.cidb.org.za/.

The address provided for the lodging of appeals is:

The Chairperson
Bid Appeals Tribunal
Private Bag X9082
Pietermaritzburg
3200

FAX NO.: 033 897 4501

T1.1 TENDER NOTICE AND INVITATION TO TENDER

CONTRACT NO. ZNB01307/00000/00/POR/INF/22/T: PROVISION OF MAINTENANCE ON VARIOUS PROVINCIAL ROADS OVER A PERIOD OF 36 MONTHS WITHIN UMZUMBE SOUTHERN ZONE 1 UNDER COST CENTRE PORT SHEPSTONE IN THE DURBAN REGION.

The Province of KwaZulu-Natal, Department of Transport, invites tenders from contractors, experienced in roadworks, for the Maintenance on various Provincial Roads Over A Period Of 36 Months Within Umzumbe Southern Zone 1 Under Cost Centre Port Shepstone In the Durban Region. This project is in the province of KwaZulu-Natal in the district municipality of Ugu and local municipality of Umzumbe. The duration of the project is 36 months.

Only tenderers that satisfy the eligibility criteria stipulated in clause C.2.1 of the Tender Data are eligible to have their tenders considered.

Tenders must have a minimum CIDB contractor grading designation of 8CE or higher.

The requirements of the CIDB B.U.I.L.D. Programme with respect to Indirect Targeting for Enterprise Development is set at a minimum contribution of 30% of the project's contract value towards subcontracting. The contractor shall also be required to provide developmental support to Targeted Enterprises. (As per CIDB B.U.I.L.D Program – only for projects that are R20 million (Grade 7) and above and have minimum duration of 6 months)

The requirements of the CIDB B.U.I.L.D. Programme with respect to the Standard for Skills Development is set at a minimum development support of 0.25% of the project's contract value. (As per CIDB B.U.I.L.D Program – only for projects that are R20 million (Grade 7) and above and have minimum duration of 6 months)

Tenderers shall be required to demonstrate that they will have in their employ during the contract period the necessary personnel satisfying the requirements of the Scope of Work for labour-enhanced competencies for management and supervisory personnel.

Preference points are offered to tenderers who comply with the requirements of PPPFA stipulated in clause C.3.11.1 of the Tender Data.

Tender documents will be available as from **11h00** on **Wednesday, 13 March 2024** during working hours (i.e., 08:00 to 16:00 Monday to Friday) until 15:00 on the day prior to the Clarification Meeting.

Free download of tender documents will be available on the www.kzntransport.gov.za and www.etenders.gov.za website and must be downloaded.

Queries relating to this tender may be addressed to:

Bidding procedure enquiries:	Technical enquiries:
Mr Nad Govender Telephone: 031 700 2222 E-mail: Nad.Govender@Kzntransport.gov.za	Mr Moahloli Makoro Telephone: 039 688 4340 E-mail: moahloli.makoro@kzntransport.gov.za

Deadline for the submission of all technical enquiries is **11 April 2024 at 16h00.**

A compulsory Clarification Meeting with representatives of the Employer will be held the Cost Centre Port Shepstone, 05 Memorial Road, Port Shepstone on **Wednesday, 27 March 2024 starting at 11h00.**

The closing time for receipt of tenders is **11h00 on Monday, 22 April 2024.** Telegraphic, telephonic, telex, facsimile, electronic, e-mail and late tenders will not be accepted.

Requirements for sealing, addressing, delivery, opening and assessment of tenders are stated in the Tender Data.

CLARIFICATION MEETING VENUE PLAN

Venue: Department of Transport, Cost Centre Port Shepstone Office
05 Memorial Road, Port Shepstone

From the R102 Southbound, at the major robot intersection turn right into Aiken Street. At the 5th intersection turn left into Robinson Street. At the 2nd intersection turn right into Memorial Road. The Department of Transport Cost Centre Offices are situated on the left-hand side 300m down the road.

Date and Time: 27 March 2024, 11h00

GPS co- ordinates: 30°44'10" S; 30°26'45" E



T1.2 TENDER DATA

The conditions of tender are the standard conditions of tender contained in Annex C of the Construction Industry Development Board Standard for Uniformity in Engineering and Construction Works Contracts, published in Government Gazette No. 42622 dated 8 August 2019.

The standard conditions of tender make several references to the tender data for details that apply specifically to this tender. The tender data shall have precedence in the interpretation of any ambiguity or inconsistency between the tender data and the standard conditions of tender.

Each item of data given below is cross-referenced to the clause in the standard conditions of tender to which it mainly applies.

Clause Number	Data
C.1.2	<p>The Tender Documents consist of the following:</p> <p>(a) This Project Document, which contains the following:</p> <p>PART T1: TENDERING PROCEDURES T1.1 Tender Notice and Invitation to Tender T1.2 Tender Data</p> <p>PART T2: RETURNABLE DOCUMENTS T2.1 List of Returnable Documents T2.2 Returnable Schedules</p> <p>PART C1: AGREEMENTS AND CONTRACT DATA C1.1 Form of Offer and Acceptance C1.2 Contract Data C1.3 Performance Guarantee C1.4 Agreement in terms of Section 37(2) of the Occupational Health and Safety Act No. 85 of 1993 C1.5 Retention Money Guarantee C1.6 Transfer of Rights</p> <p>PART C2: PRICING DATA C2.1 Pricing Assumptions C2.2 Bill of Quantities</p> <p>PART C3: SCOPE OF WORK C3.1 Standard Specifications C3.2 Project Specifications C3.3 Particular Specifications</p> <p>PART C4: SITE INFORMATION C4.1 Locality Plan C4.2 Example of Contract Signboard Details C4.3 Existing Services Report C4.4 Conditions on Site: Materials Information C4.5 Traffic Information C4.6 Standard Details C4.7 Any other relevant technical reports</p> <p>(b) Drawings (issued separately by the Employer's agent).</p> <p>(c) 'General Conditions of Contract for Construction Works, Third Edition (2015)' issued by the South African Institution of Civil Engineering (abbreviated title 'General Conditions of Contract 2015' – 'GCC 2015'). This document is obtainable separately and Tenderers shall obtain their own copy.</p>

Clause Number	Data
	<p>(d) 'Standard Specifications for Road and Bridge Works for South African Road Authorities (Draft Standard) (October 2020). This document is obtainable separately and Tenderers shall obtain their own copy.</p> <p>(e) 'Occupational Health and Safety Act No. 85 of 1993', 'Occupational Health and Safety Amendment Act No. 181 of 1993', and the 'Construction Regulations, 2014' (Government Notice No. R. 489 published in Government Gazette No. 40883 of 2 June 2017,). These documents are obtainable separately and Tenderers shall obtain their own copies.</p> <p>(f) 'Construction Industry Development Board Act No. 38 of 2000' as amended and the 'Regulations in terms of the Construction Industry Development Board Act No. 38 of 2000' (Government Notice No. R. 692 published in Government Gazette No. 26427 of 9 June 2004, as amended).</p> <p>In addition, Tenderers are advised, in their own interest, to obtain their own copies of the relevant Acts, Regulations and Standards referred to in this document as they are essential for the Tenderer to become acquainted with the basics of construction management, the implementation of preferential construction procurement policies, and participation of targeted enterprises and labour.</p>
C.1.4	<p>The Employer's Agent is:</p> <p>Name of the entity: KZN DOT Contact person: Mr M Makoro Telephone: 039 688 4340 Fax: 039 682 0124 E-mail: Moahloli.Makoro@Kzntransport.gov.za</p>
C.2.1	<p>Only those tenderers who satisfy the following criteria are eligible to submit tenders.</p> <p>(a) CIDB registration</p> <p>Only those tenderers who are registered with the CIDB, or are capable of being so prior to the evaluation of submissions, in a contractor grading designation equal to or higher than a contractor grading designation determined in accordance with the sum tendered, or a value determined in accordance with Regulation 25 (1B) or 25(7A) of the Construction Industry Development Regulations, for a Grade 8 CE class of construction work, are eligible to have their tenders evaluated.</p> <p>Only contractors whose CIDB status is "Active" at the time of tender evaluation will be considered for further evaluation. Contractors whose status is "Suspended" or "Expired" will not be considered for evaluation and will be disqualified from the bidding process.</p> <p>Joint ventures are eligible to submit tenders provided that:</p> <p>(i) every member of the joint venture is registered with the CIDB;</p> <p>(ii) the lead partner has a contractor grading designation in the 7 CE class of construction work; not lower than one level below the required grading designation in the class of construction work under consideration and possesses the required recognition status; and</p> <p>(iii) the combined contractor grading designation calculated in accordance with the Construction Industry Development Regulations is equal to or higher than, 8 for a CE class of construction work or a value determined in accordance with Regulation 25 (1B) or 25(7A) of the Construction Industry Development Regulations.</p>

Clause Number	Data
	<p>(b) Central Supplier Database (CSD)</p> <p>Tenderers, or in the event of a joint venture, each member of the joint venture, must be registered on the Central Supplier Database at the time of evaluation. Tenders received from such tenderers who do not comply with this requirement, will be considered non-responsive.</p> <p>Prospective suppliers should self-register on the CSD website www.csd.gov.za.</p>
C.2.7	<p>This will be a compulsory clarification meeting. It is recommended that the contractors perform a physical site visit prior to the closure of the bid.</p> <p>The arrangements and venue for the compulsory Clarification Meeting are:</p> <p>Venue: Department of Transport, Cost Centre Port Shepstone Office, 05 Memorial Road, Port Shepstone</p> <p>Date: 27 March 2024, 11h00</p> <p>Contact person: Mr Moahloli Makoro</p> <p>Telephone: 039 688 4340</p> <p>Fax: 039 682 2622</p> <p>E-mail: Moahloli.Makoro@Kzntransport.gov.za</p>
C.2.10	<p>All Tenderers that are registered for Value Added Tax (VAT) with the South African Revenue Service (SARS) must include VAT in their tender offer.</p>
C.2.11	<p>The tenderer shall not retype the tender document.</p> <p><u>Any tender submitted using a document that has been retyped shall be considered non-responsive and rejected in terms of clause C.3.8 of the Conditions of Tender.</u></p>
C.2.12	<p>The requirements are as described in clause A2.1.4.2'ALTERNATIVE DESIGNS' of the 'COTO Standard Specifications for Road and Bridge Works for South African Road Authorities (Draft Standard) (October 2020 edition)'.</p>
C.2.13	<p>C.2.13.3 Tender offers shall be submitted as an original only. Under no circumstances whatsoever may the tender forms be retyped or redrafted. Photocopies of the original tender documentation may be used, but an original signature must appear on such photocopies.</p> <p>C.2.13.5 The Employer's address for delivery of tender offers and identification details to be shown on each tender offer package are:</p> <p>Location of Tender Box: Outside the Foyer, KZN Department of Transport</p> <p>Physical Address: 4 Aubrey Road, Westmead, Pinetwon,3610</p> <p>Identification Details: Contract No. ZNB01307/00000/00/POR/INF/22/T</p>
C.2.13.6	<p>A two-envelope system <u>will NOT be followed.</u></p>

Clause Number	Data
C.2.15	<p>The closing time for submission of Tender Offers is: 11h00 on Monday, 22 April 2024</p> <p>Telegraphic, telephonic, telex, facsimile, electronic, e-mail and late tenders will not be accepted.</p>
C.2.16	<p>The tender offer validity period is twelve (12) weeks, calculated from the date of bid closure.</p>
C.2.18	<p>The tenderer must submit to the Employer the names of all management and supervisory staff that will be employed to supervise the labour-enhanced portion of the works together with satisfactory evidence that such staff members satisfy the eligibility requirement (refer to Returnable Schedule H).</p>
C.2.19	<p>Access shall be provided for inspections and testing by personnel acting on behalf of the Employer.</p>
C.2.23	<p>The certificates as required in the Returnable Schedules and Forms must be provided with the tender for each party to a consortium / joint venture.</p>
C.3.4	<p>The time and location for opening of the tender submissions are: Time: 11h00 Date: 22 April 2024</p> <p>Location / Venue: Outside the Foyer, KZN Department of Transport, 4 Aubrey Road, Westmead, Pinetown, 3610</p>
C.3.5	<p>A two-envelope system will not be followed.</p>
C.3.8.1	<p>Test for responsiveness</p> <p>Determine, after opening and before detailed evaluation, whether each tender offer properly received:</p> <ul style="list-style-type: none"> a) complies with the requirements of these Conditions of Tender, b) has been properly and fully completed and signed, and c) is responsive to the other requirements of the tender documents. <p>A responsive tender is one that conforms to all the terms, conditions, and specifications of the tender documents without material deviation or qualification. A material deviation or qualification is one which, in the Employer's opinion, would:</p> <ul style="list-style-type: none"> a) detrimentally affect the scope, quality, or performance of the works, services or supply identified in the Scope of Work, b) significantly change the Employer's or the tenderer's risks and responsibilities under the contract, or c) affect the competitive position of other tenderers presenting responsive tenders, if it were to be rectified. <p>Reject a non-responsive tender offer, and not allow it to be subsequently made responsive by correction or withdrawal of the non-conforming deviation or reservation.</p>
C3.9	<p>Arithmetical errors, omissions and discrepancies</p>

Clause Number	Data								
C.3.9.2	<p>Check responsive tenders for discrepancies between amounts in words and amounts in figures. Where there is a discrepancy between the amounts in figures and the amount in words, the amount in words shall govern.</p> <p>Check the highest ranked tender or tenderer with the highest number of tender evaluation points after the evaluation of tender offers in accordance with C.3.11 for:</p> <p>a) the gross misplacement of the decimal point in any unit rate;</p> <p>b) omissions made in completing the pricing schedule or bills of quantities; or</p> <p>c) arithmetic errors in:</p> <p style="padding-left: 40px;">(i) line item totals resulting from the product of a unit rate and a quantity in bills of quantities or schedules of prices; or</p> <p style="padding-left: 40px;">(ii) the summation of the prices.</p>								
C.3.9.3	<p>Notify the tenderer of all errors or omissions that are identified in the tender offer and either confirm the tender offer as tendered or accept the corrected total of prices.</p>								
C.3.9.4	<p>Where the tenderer elects to confirm the tender offer as tendered, correct the errors as follows:</p> <p>a) If bills of quantities or pricing schedules apply and there is an error in the line item total resulting from the product of the unit rate and the quantity, the line item total shall govern and the rate shall be corrected. Where there is an obviously gross misplacement of the decimal point in the unit rate, the line item total as quoted shall govern, and the unit rate shall be corrected.</p> <p>b) Where there is an error in the total of the prices either as a result of other corrections required by this checking process or in the tenderer's addition of prices, the total of the prices shall govern and the tenderer will be asked to revise selected item prices (and their rates if bills of quantities apply) to achieve the tendered total of the prices.</p>								
C.3.10	<p>Obtain clarification from a tenderer on any matter that could give rise to ambiguity in a contract arising from the tender offer.</p>								
C3.11.1	<p>The evaluation of tender offers will be based on administrative compliance, price and preference in accordance with the Preferential Procurement Regulations, 2022 and KwaZulu-Natal Department of Transport (KZNDOT) Interim Preferential Procurement Policy – January 2023, as amended.</p> <p>The scope of work for this contract is classified in the following table.</p> <table border="1" data-bbox="363 1391 1461 1641"> <thead> <tr> <th data-bbox="363 1391 1289 1422">Classification of Work</th> <th data-bbox="1289 1391 1461 1422">YES / NO</th> </tr> </thead> <tbody> <tr> <td data-bbox="363 1422 1289 1516">Simple/straightforward/routine work - where the tasks or activities are of a straightforward nature in terms of which inputs are relatively well known and outputs can be readily defined.</td> <td data-bbox="1289 1422 1461 1516" style="text-align: center;">YES</td> </tr> <tr> <td data-bbox="363 1516 1289 1574">Complex work - characterised by requirements for higher levels of skills, greater resources or not well-defined inputs and outputs.</td> <td data-bbox="1289 1516 1461 1574" style="text-align: center;">NO</td> </tr> <tr> <td data-bbox="363 1574 1289 1641">Specialist work - requiring considerable innovation, creativity, and expertise or skill (or both) or work that has a high downstream impact.</td> <td data-bbox="1289 1574 1461 1641" style="text-align: center;">NO</td> </tr> </tbody> </table> <p>a) <u>Price and preference</u></p> <p>Tenders will be evaluated on price and preference in accordance with the Preferential Procurement Regulations, 2022 and KZNDOT Interim Preferential Procurement Policy-January 2023.</p> <p>Specific goals points must be claimed using Returnable Schedule D - SDB 6.1 in accordance with the tenderer's Company and Intellectual Property Commission (CIPC) company registration documents, Central Supplier Database report, B-BBEE status level of contributor or Sworn affidavit as per construction sector code and proof of participation on job creation that is provided as returnable schedule K. The Acceptable Proof for the Allocation of Specific Goals Points, as detailed in Section Q - Acceptable Proof & Right to Award, must be attached to</p>	Classification of Work	YES / NO	Simple/straightforward/routine work - where the tasks or activities are of a straightforward nature in terms of which inputs are relatively well known and outputs can be readily defined.	YES	Complex work - characterised by requirements for higher levels of skills, greater resources or not well-defined inputs and outputs.	NO	Specialist work - requiring considerable innovation, creativity, and expertise or skill (or both) or work that has a high downstream impact.	NO
Classification of Work	YES / NO								
Simple/straightforward/routine work - where the tasks or activities are of a straightforward nature in terms of which inputs are relatively well known and outputs can be readily defined.	YES								
Complex work - characterised by requirements for higher levels of skills, greater resources or not well-defined inputs and outputs.	NO								
Specialist work - requiring considerable innovation, creativity, and expertise or skill (or both) or work that has a high downstream impact.	NO								

Clause Number	Data
	<p>Returnable Schedule D - SBD6.1. For proof of disability, an official letter from a Doctor certified by the Department of Health Occupational Doctor confirming the disability is required to be attached.</p> <p>The tenderer's B-BBEE Status Level Verification Certificate must comply with the requirements of Returnable Schedule E and be submitted as an attachment to the returnable schedule.</p> <p>The Employer may perform a risk analysis on the preferred tenderer as per the provisions of Section 3.6 of the CIDB Inform Practice Note #5 Version 3 - September 2020 or as amended.</p> <p><u>Total Score for Price and Preference</u> The points scored for a Tenderer in respect of Price will be added to the points scored in respect of Preference. Only the tender with the highest number of points may be selected, except in those instances permissible by legislation, practice notes or relevant policies.</p>
C.3.13	<p>(e) The legal requirements for acceptance of the tender offer are:</p> <ul style="list-style-type: none"> (i) Tender Defaulters Register - the Tenderer or any of its principals is <u>not</u> listed on the register of Tender Defaulters in terms of the Prevention and Combating of Corrupt Activities Act of 2004 as a person prohibited from doing business with the public sector. (ii) Abuse of the SCM System - the Tenderer has <u>not</u> abused the Employer's Supply Chain Management System and has <u>not</u> been given a written notice to the effect that he has failed to perform on any previous contract. (iii) Declaration - the Tenderer has indicated and declared whether a spouse, child or parent of the Tenderer is in the service of the State. (iv) Fraud and Corruption - the Employer is satisfied that the Tenderer or any of his principals have <u>not influenced</u> the tender offer and acceptance by the following criteria: <ul style="list-style-type: none"> • having offered, promised or given a bribe or other gift or remuneration to any person in connection with the obtaining of this Contract; • having acted in a fraudulent or corrupt manner in obtaining this Contract; • having approached an officer or employee of the Employer or the Employer's Agent with the object of influencing the award of a Contract in the Tenderer's favour; • having entered into any agreement or arrangement, whether legally binding or not, with any other person, firm or company to refrain from Tendering for this Contract or as to the amount of the Tender to be submitted by either party; or • having disclosed to any other person, firm or company other than the Employer, the exact or approximate amount of his proposed Tender. <p>The Employer may, in addition to using any other legal remedies, repudiate the Tender offer and acceptance and declare the Contract invalid should it have been concluded already.</p>
C.3.17	<p>The number of paper copies of the signed contract to be provided by the Employer is one (1).</p>

PART T2: RETURNABLE DOCUMENTS

T2.1 LIST OF RETURNABLE DOCUMENTS

The following schedules and forms are contained in this document and are to be properly completed as required:

- (a) Returnable Schedules in T2.2.
- (b) C1.1 Form of Offer and Acceptance, C1.1.1: Offer, on page C3.
- (c) Contract Specific Data Provided by the Contractor in C1.2.3.
- (d) Pricing Data in C2.2: Bill of Quantities.

This tender applies to both the (a) Skills Development Standard and the (b) Indirect Targeting Standard. Although in the case of these two standards there are no returnable documents, tenderers are sensitised that the proforma documents as listed below, shall be completed by the successful contractor after award of the contract within the stipulated period. (The proforma documents are provided in the tender data for information purposes only).

- Form A 1 List of Recognised Skills Development Agencies
- Form A 2 Baseline Training Plan
- Form A 3 Project Interim Report
- Form A 4 Supervisor Agreement
- Form A 5 Project Completion Report.
- Project Interim Report
- Project Completion Report and Declaration.

T2.2 RETURNABLE SCHEDULES

A	COMPULSORY CLARIFICATION MEETING	T15
B	RECORD OF ADDENDA TO TENDER DOCUMENTS.....	T16
C	COMPULSORY ENTERPRISE QUESTIONNAIRE.....	T17
D	STANDARD BIDDING DOCUMENTS	T18
	SBD 1: INVITATION TO BID.....	T18
	SDB 4: BIDDER'S DISCLOSURE	T20
	SBD 5: THE NATIONAL INDUSTRIAL PARTICIPATION PROGRAMME (<i>Not Applicable</i>)	T23
	SBD 6.1: PREFERENCE POINTS CLAIM FORM IN TERMS OF THE PREFERENTIAL PROCUREMENT REGULATIONS 2017	T25
E	B-BBEE VERIFICATION CERTIFICATE	T32
F	CERTIFICATE OF AUTHORITY FOR SIGNATORY.....	T33
G	CONSTRUCTION EXPERIENCE	T35
H	KEY PERSONNEL.....	T36
I	CONSTRUCTION EQUIPMENT	T39
J	PROPOSED SUBCONTRACTORS.....	T40
K	PARTICIPATION IN JOB CREATION USING LOCAL LABOUR	T41
L	BIDDERS HEALTH AND SAFETY DECLARATION.....	T43
M	DEVIATIONS AND QUALIFICATIONS.....	T45
N	SCHEDULE OF ALTERNATIVE TENDERS.....	T46
O	TECHNICAL PROPOSAL	T47
P	NOTICES TO TENDERERS REGARDING THE COMPLETION OF FORMS.....	T49
Q	ACCEPTABLE PROOF & RIGHT TO AWARD	T50

NOTE: The Tenderer is required to complete each schedule and form listed above to the best of his ability as the evaluation of tenders and the eventual contract will be based on the information provided by the Tenderer. Failure of a Tenderer to complete the schedules and forms to the satisfaction of the Employer may lead to rejection on the grounds that the tender is non-responsive.

A. COMPULSORY CLARIFICATION MEETING

This is to certify that (*Supplier*)

of (*address*)

.....
was represented by the person named below at the compulsory clarification meeting held for all tenderers at the Department of Transport's Cost Centre Port Shepstone, 05 Memorial Road, Port Shepstone, 4240 (refer to the Clarification Meeting Venue Plan in Section T1.1) on **Wednesday, 27 March 2024**, starting at **11h00**.

I acknowledge that the purpose of the meeting was to acquaint myself with the site of the works and / or matters incidental to doing the work specified in the tender documents in order for me to take account of everything necessary when compiling our rates and prices included in the tender.

Particulars of person attending the meeting:

Name: Signature:

Capacity:

Attendance of the above person at the meeting is confirmed by the Employer or Employer's Agent, namely:

Name: Signature:

Capacity: Date and Time:

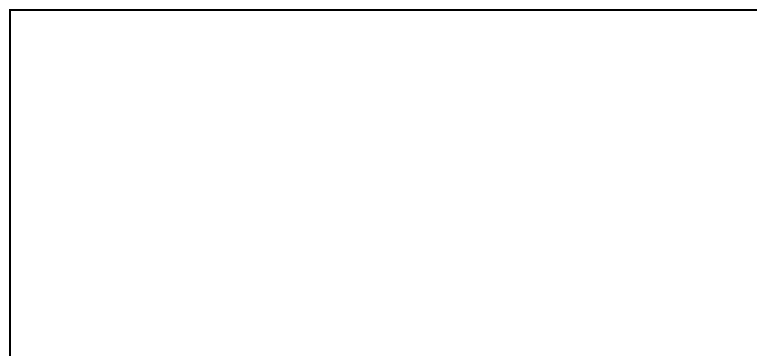

Any tender submitted that does not bear the signature of the Employer or Employer's Agent on this page shall be considered non-responsive and rejected in terms of clause C.3.8 of the Conditions of Tender.

B. RECORD OF ADDENDA TO TENDER DOCUMENTS

The undersigned confirm that the following communications received from the Employer or his representative before the date of submission of this tender offer, amending the tender documents, have been considered in this tender offer. ***(Addenda can only be issued following approval from the Employer. The Employer’s representative is not allowed to issue addenda to bidders without prior approval in terms of the SCM Delegations).***

ADDENDUM NO.	DATE	TITLE OR DETAILS

Signed		Date	
Name		Position	
Bidder			

Failure to complete, sign and date this form or failure to acknowledge receipt and effect changes of each Addendum issued shall result in the tender being considered non-responsive and rejected in terms of clause C.3.8 of the Conditions of Tender.

C. COMPULSORY ENTERPRISE QUESTIONNAIRE

The following particulars must be furnished. In the case of a joint venture, separate enterprise questionnaires in respect of each partner must be completed and submitted.			
Section 1: Name of enterprise:			
Section 2: VAT registration number, if any:			
Section 3: CIDB registration number, if any:			
Section 4: CSD number:			
Section 5: Particulars of sole proprietors and partners in partnerships:			
Name*	Identity number*	Personal income tax number*	
<i>* Complete only if sole proprietor or partnership and attach separate page if more than 3 partners</i>			
Section 6: Particulars of companies and close corporations			
Company registration number:			
Close corporation number:			
Tax reference number:			
Section 7: SBD4 issued by National Treasury must be completed for each tender and be attached as a tender requirement.			
Section 8: SBD 6 issued by National Treasury must be completed for each tender and be attached as a tender requirement.			
The undersigned, who warrants that he / she is duly authorised to do so on behalf of the enterprise:			
i) Authorizes the employer to verify the tenderers tax clearance status from the South African Revenue Services that it is in order.			
ii) confirms that the neither the name of the enterprise or the name of any partner, manager, director or other person, who wholly or partly exercises or may exercise, control over the enterprise appears on the Register of Tender Defaulters established in terms of the Prevention and Combating of Corrupt Activities Act of 2004;			
iii) Confirms that no partner, member, director or other person, who wholly or partly exercises, or may exercise, control over the enterprise appears, has within the last five years been convicted of fraud or corruption.			
iv) confirms that I / we are not associated, linked or involved with any other tendering entities submitting tender offers and have no other relationship with any of the tenderers or those responsible for compiling the scope of work that could cause or be interpreted as a conflict of interest; and			
iv) Confirms that the contents of this questionnaire are within my personal knowledge and are to the best of my belief both true and correct.			
Signed		Date	
Name		Position	
<i>Enterprise name</i>			

Failure to complete, sign and date this form shall result in the tender being considered non-responsive and rejected in terms of clause C.3.8 of the Conditions of Tender.

D. STANDARD BIDDING DOCUMENTS

**SECTION A
INVITATION TO BID**

SBD1

YOU ARE HEREBY INVITED TO TENDER FOR REQUIREMENTS OF THE KWAZULU-NATAL DEPARTMENT OF TRANSPORT					
BID NUMBER:	ZNB01307/00000/00/POR/INF/22/T	CLOSING DATE: 22 April 2024	CLOSING TIME:	11h00	
DESCRIPTION	PROVISION OF MAINTENANCE ON VARIOUS PROVINCIAL ROADS OVER A PERIOD OF 36 MONTHS WITHIN UMZUMBE SOUTHERN ZONE 1 UNDER COST CENTRE PORT SHEPSTONE IN THE DURBAN REGION				
TENDER RESPONSE DOCUMENTS MAY BE DEPOSITED IN THE BID BOX SITUATED AT (STREET ADDRESS)					
Outside the Foyer, KZN Department of Transport 4 Aubrey Road, Westmead, Pinetown 3610			Monday to Friday: 08:00 until 16:00 <i>Under no circumstances must suppliers submit their Tender offers/ responses to the official whose name appears on the enquiries.</i>		
BIDDING PROCEDURE ENQUIRIES MAY BE DIRECTED TO			TECHNICAL ENQUIRIES MAY BE DIRECTED TO:		
CONTACT PERSON	Nad Govender		CONTACT PERSON	Mr Moahloli Makoro	
TELEPHONE NUMBER	031 700 2222		TELEPHONE NUMBER	039 688 4340	
FACSIMILE NUMBER	N/A		FACSIMILE NUMBER	N/A	
E-MAIL ADDRESS	Nad.Govender@kzntransport.gov.za		E-MAIL ADDRESS	moahloli.makoro@kzntransport.gov.za	
SUPPLIER INFORMATION					
NAME OF BIDDER					
POSTAL ADDRESS					
STREET ADDRESS					
TELEPHONE NUMBER	CODE		NUMBER		
CELLPHONE NUMBER					
FACSIMILE NUMBER	CODE		NUMBER		
E-MAIL ADDRESS					
VAT REGISTRATION NUMBER					
SUPPLIER COMPLIANCE STATUS	TAX COMPLIANCE SYSTEM PIN:		OR	CENTRAL SUPPLIER DATABASE NO:	MAAA
B-BBEE STATUS LEVEL VERIFICATION CERTIFICATE	TICK APPLICABLE BOX] <input type="checkbox"/> Yes <input type="checkbox"/> No		B-BBEE STATUS LEVEL SWORN AFFIDAVIT	[TICK APPLICABLE BOX] <input type="checkbox"/> Yes <input type="checkbox"/> No	
[A B-BBEE STATUS LEVEL VERIFICATION CERTIFICATE/ SWORN AFFIDAVIT (FOR EME & QSE) MUST BE SUBMITTED IN ORDER TO QUALIFY FOR PREFERENCE POINTS FOR B-BBEE]					
ARE YOU THE ACCREDITED REPRESENTATIVE IN SOUTH AFRICA FOR THE GOODS /SERVICES /WORKS OFFERED?	<input type="checkbox"/> Yes <input type="checkbox"/> No [IF YES ENCLOSE PROOF]		ARE YOU A FOREIGN BASED SUPPLIER FOR THE GOODS /SERVICES /WORKS OFFERED?	<input type="checkbox"/> Yes <input type="checkbox"/> No [IF YES, ANSWER THE QUESTIONNAIRE BELOW]	
QUESTIONNAIRE TO BIDDING FOREIGN SUPPLIERS					
IS THE ENTITY A RESIDENT OF THE REPUBLIC OF SOUTH AFRICA (RSA)?				<input type="checkbox"/> YES	<input type="checkbox"/> NO
DOES THE ENTITY HAVE A BRANCH IN THE RSA?				<input type="checkbox"/> YES	<input type="checkbox"/> NO
DOES THE ENTITY HAVE A PERMANENT ESTABLISHMENT IN THE RSA?				<input type="checkbox"/> YES	<input type="checkbox"/> NO
DOES THE ENTITY HAVE ANY SOURCE OF INCOME IN THE RSA?				<input type="checkbox"/> YES	<input type="checkbox"/> NO
IS THE ENTITY LIABLE IN THE RSA FOR ANY FORM OF TAXATION?				<input type="checkbox"/> YES	<input type="checkbox"/> NO
IF THE ANSWER IS "NO" TO ALL OF THE ABOVE, THEN IT IS NOT A REQUIREMENT TO REGISTER FOR A TAX COMPLIANCE STATUS SYSTEM PIN CODE FROM THE SOUTH AFRICAN REVENUE SERVICE (SARS) AND IF NOT REGISTER AS PER 2.3 BELOW.					

PART B
TERMS AND CONDITIONS FOR BIDDING

1. BID SUBMISSION:
1.1. BIDS MUST BE DELIVERED BY THE STIPULATED TIME TO THE CORRECT ADDRESS. LATE BIDS WILL NOT BE ACCEPTED FOR CONSIDERATION.
1.2. ALL BIDS MUST BE SUBMITTED ON THE OFFICIAL FORMS PROVIDED–(NOT TO BE RE-TYPED) OR IN THE MANNER PRESCRIBED IN THE BID DOCUMENT.
1.3. THIS BID IS SUBJECT TO THE PREFERENTIAL PROCUREMENT POLICY FRAMEWORK ACT, 2000 AND THE PREFERENTIAL PROCUREMENT REGULATIONS, 2022, THE GENERAL CONDITIONS OF CONTRACT (GCC) AND, IF APPLICABLE, ANY OTHER SPECIAL CONDITIONS OF CONTRACT.
1.4. IF THE BID WAS INVITED THROUGH A CLOSE QUOTATION PROCESS; WHERE SUPPLIERS WERE SOURCED FROM CSD USING THE COMMODITY PROCESS; SUPPLIERS WHO WERE NOT INVITED WILL NOT BE CONSIDERED.
1.5. USE OF OMISSION IN THE DOCUMENT IS PROHIBITED, ALL CORRECTIONS MUST BE INITIALED BY TENDERER AND USE OF CORRECTION FLUID IS PROHIBITED.
1.6. FAILING TO COMPLY WITH THE ABOVE REQUIREMENTS WILL RESULT IN THE BID BEING NON-RESPONSIVE.
1.7. THE SUCCESSFUL BIDDER WILL BE REQUIRED TO FILL IN AND SIGN A WRITTEN CONTRACT.
2. TAX COMPLIANCE REQUIREMENTS
2.1 BIDDERS MUST ENSURE COMPLIANCE WITH THEIR TAX OBLIGATIONS.
2.2 BIDDERS ARE REQUIRED TO SUBMIT THEIR UNIQUE PERSONAL IDENTIFICATION NUMBER (PIN) ISSUED BY SARS TO ENABLE THE ORGAN OF STATE TO VERIFY THE TAXPAYER’S PROFILE AND TAX STATUS.
2.3 APPLICATION FOR TAX COMPLIANCE STATUS (TCS) PIN MAY BE MADE VIA E-FILING THROUGH THE SARS WEBSITE WWW.SARS.GOV.ZA.
2.4 BIDDERS MAY ALSO SUBMIT A PRINTED TCS CERTIFICATE TOGETHER WITH THE BID.
2.5 IN BIDS WHERE CONSORTIA / JOINT VENTURES / SUB-CONTRACTORS ARE INVOLVED, EACH PARTY MUST SUBMIT A SEPARATE TCS CERTIFICATE / PIN / CSD NUMBER.
2.6 WHERE NO TCS IS AVAILABLE BUT THE BIDDER IS REGISTERED ON THE CENTRAL SUPPLIER DATABASE (CSD), A CSD NUMBER MUST BE PROVIDED.
2.7 NO BIDS WILL BE CONSIDERED FROM PERSONS IN THE SERVICE OF THE STATE, COMPANIES WITH DIRECTORS WHO ARE PERSONS IN THE SERVICE OF THE STATE, OR CLOSE CORPORATIONS WITH MEMBERS PERSONS IN THE SERVICE OF THE STATE.”
3. COMPLIANCE AND RETURNABLES: THE FOLLOWING RETURNABLE DOCUMENTS MUST RETURNED WITH THE TENDER DOCUMENT
3.1 SCM APPENDIX 1 INVITATION TO TENDER (SBD1 PART A).
3.2 SCM APPENDIX 2 – TERMS AND CONDITIONS FOR BIDDING (SBD1 PART B).
3.3 SCM APPENDIX 3 – OFFICIAL BRIEFING SESSION/SITE INSPECTION CERTIFICATE.
3.4 SBD 4 - DECLARATION OF INTEREST FORM.
3.5 SBD 6.1 - PREFERENCE POINTS CLAIM FORM IN TERMS OF THE PREFERENTIAL PROCUREMENT REGULATIONS 2022.

NB: FAILURE TO PROVIDE / OR COMPLY WITH ANY OF THE ABOVE PARTICULARS MAY RENDER THE BID INVALID.

SIGNATURE OF BIDDER:

CAPACITY UNDER WHICH THIS BID IS SIGNED:

(Proof of authority must be submitted e.g. company resolution)

DATE:

SBD 4
BIDDER'S DISCLOSURE

1. PURPOSE OF THE FORM

Any person (natural or juristic) may make an offer or offers in terms of this invitation to bid. In line with the principles of transparency, accountability, impartiality, and ethics as enshrined in the Constitution of the Republic of South Africa and further expressed in various pieces of legislation, it is required for the bidder to make this declaration in respect of the details required hereunder.

Where a person/s are listed in the Register for Tender Defaulters and / or the List of Restricted Suppliers, that person will automatically be disqualified from the bid process.

2. Bidder's declaration

2.1 Is the bidder, or any of its directors / trustees / shareholders / members / partners or any person having a controlling interest¹ in the enterprise, employed by the state? **YES/NO**

2.1.1 If so, furnish particulars of the names, individual identity numbers, and, if applicable, state employee numbers of sole proprietor/ directors / trustees / shareholders / members/ partners or any person having a controlling interest in the enterprise, in table below.

Full Name	Identity Number	Name of institution	State

2.2 Do you, or any person connected with the bidder, have a relationship with any person who is employed by the procuring institution? **YES/NO**

2.2.1 If so, furnish particulars:
.....
.....

¹ the power, by one person or a group of persons holding the majority of the equity of an enterprise, alternatively, the person/s having the deciding vote or power to influence or to direct the course and decisions of the enterprise.

2.3 Does the bidder or any of its directors / trustees / shareholders / members / partners or any person having a controlling interest in the enterprise have any interest in any other related enterprise whether or not they are bidding for this contract?

YES/NO

2.3.1 If so, furnish particulars:

.....
.....

3 DECLARATION

I, the undersigned,
(name)..... in submitting the accompanying bid, do hereby make the following statements that I certify to be true and complete in every respect:

- 3.1 I have read and I understand the contents of this disclosure;
- 3.2 I understand that the accompanying bid will be disqualified if this disclosure is found not to be true and complete in every respect;
- 3.3 The bidder has arrived at the accompanying bid independently from, and without consultation, communication, agreement or arrangement with any competitor. However, communication between partners in a joint venture or consortium² will not be construed as collusive bidding.
- 3.4 In addition, there have been no consultations, communications, agreements or arrangements with any competitor regarding the quality, quantity, specifications, prices, including methods, factors or formulas used to calculate prices, market allocation, the intention or decision to submit or not to submit the bid, bidding with the intention not to win the bid and conditions or delivery particulars of the products or services to which this bid invitation relates.
- 3.4 The terms of the accompanying bid have not been, and will not be, disclosed by the bidder, directly or indirectly, to any competitor, prior to the date and time of the official bid opening or of the awarding of the contract.
- 3.5 There have been no consultations, communications, agreements or arrangements made by the bidder with any official of the procuring institution in relation to this procurement process prior to and during the bidding process except to provide clarification on the bid submitted where so required by the institution; and the bidder was not involved in the drafting of the specifications or terms of reference for this bid.
- 3.6 I am aware that, in addition and without prejudice to any other remedy provided to combat any restrictive practices related to bids and contracts, bids that are suspicious will be reported to the Competition Commission for investigation and possible imposition of administrative penalties in terms of section 59 of the Competition Act No 89 of 1998 and or may be reported to the National Prosecuting Authority (NPA) for criminal investigation and or may be restricted from conducting business with the public sector for a period not exceeding ten (10) years in terms of the Prevention and

² Joint venture or Consortium means an association of persons for the purpose of combining their expertise, property, capital, efforts, skill and knowledge in an activity for the execution of a contract.

Combating of Corrupt Activities Act No 12 of 2004 or any other applicable legislation.

I CERTIFY THAT THE INFORMATION FURNISHED IN PARAGRAPHS 1, 2 and 3 ABOVE IS CORRECT.

I ACCEPT THAT THE STATE MAY REJECT THE BID OR ACT AGAINST ME IN TERMS OF PARAGRAPH 6 OF PFMA SCM INSTRUCTION 03 OF 2021/22 ON PREVENTING AND COMBATING ABUSE IN THE SUPPLY CHAIN MANAGEMENT SYSTEM SHOULD THIS DECLARATION PROVE TO BE FALSE.

.....
Signature Date

.....
Position Name of bidder

***Every question must be answered individually on this form, whether a relationship is present or not:
Failure to do so and any non-disclosure on this Declaration will invalidate your tender/bid***

This document must be signed and submitted together with your bid.

THE NATIONAL INDUSTRIAL PARTICIPATION PROGRAMME

INTRODUCTION

The National Industrial Participation (NIP) Programme, which is applicable to all government procurement contracts that have an imported content, became effective on the 1 September 1996. The NIP policy and guidelines were fully endorsed by Cabinet on 30 April 1997. In terms of the Cabinet decision, all state and parastatal purchases / lease contracts (for goods, works and services) entered into after this date, are subject to the NIP requirements. NIP is obligatory and therefore must be complied with. The Industrial Participation Secretariat (IPS) of the Department of Trade and Industry (DTI) is charged with the responsibility of administering the programme.

1 PILLARS OF THE PROGRAMME

- 1.1 The NIP obligation is benchmarked on the imported content of the contract. Any contract having an imported content equal to or exceeding US\$ 10 million or other currency equivalent to US\$ 10 million will have a NIP obligation. This threshold of US\$ 10 million can be reached as follows:
- (a) Any single contract with imported content exceeding US\$10 million.
Or
 - (b) Multiple contracts for the same goods, works or services each with imported content exceeding US\$3 million awarded to one seller over a 2 year period which in total exceeds US\$10 million.
Or
 - (c) A contract with a renewable option clause, where should the option be exercised the total value of the imported content will exceed US\$10 million.
Or
 - (d) Multiple suppliers of the same goods, works or services under the same contract, where the value of the imported content of each allocation is equal to or exceeds US\$ 3 million worth of goods, works or services to the same government institution, which in total over a two (2) year period exceeds US\$10 million.
- 1.2 The NIP obligation applicable to suppliers in respect of sub-paragraphs 1.1 (a) to 1.1 (c) above will amount to 30 % of the imported content whilst suppliers in respect of paragraph 1.1 (d) shall incur 30 % of the total NIP obligation on a *pro-rata* basis.
- 1.3 To satisfy the NIP obligation, the DTI would negotiate and conclude agreements such as investments, joint ventures, sub-contracting, licensee production, export promotion, sourcing arrangements and research and development (R&D) with partners or suppliers.
- 1.4 A period of seven years has been identified as the time frame within which to discharge the obligation.

2 REQUIREMENTS OF THE DEPARTMENT OF TRADE AND INDUSTRY

- 2.1 In order to ensure effective implementation of the programme, successful bidders (contractors) are required to, immediately after the award of a contract that is in excess of **R10 million** (ten million Rands), submit details of such a contract to the DTI for reporting purposes.
- 2.2 The purpose for reporting details of contracts in excess of the amount of R10 million (ten million Rands) is to cater for multiple contracts for the same goods, works or services; renewable contracts and multiple suppliers for the same goods, works or services under the same contract as provided for in paragraphs 1.1.(b) to 1.1. (d) above.

3 BID SUBMISSION AND CONTRACT REPORTING REQUIREMENTS OF BIDDERS AND SUCCESSFUL BIDDERS (CONTRACTORS)

3.1 Bidders are required to sign and submit this Standard Bidding Document (SBD 5) together with the bid on the closing date and time.

3.2 In order to accommodate multiple contracts for the same goods, works or services; renewable contracts and multiple suppliers for the same goods, works or services under the same contract as indicated in sub-paragraphs 1.1 (b) to 1.1 (d) above and to enable the DTI in determining the NIP obligation, successful bidders (contractors) are required, immediately after being officially notified about any successful bid with a value in excess of R10 million (ten million Rands), to contact and furnish the DTI with the following information:

- Bid / contract number.
- Description of the goods works or services.
- Date on which the contract was accepted.
- Name, address and contact details of the government institution.
- Value of the contract.
- Imported content of the contract, if possible.

3.3 The information required in paragraph 3.2 above must be sent to the Department of Trade and Industry, Private Bag X 84, Pretoria, 0001 for the attention of Mr Elias Malapane within five (5) working days after award of the contract. Mr Malapane may be contacted on telephone (012) 394 1401, facsimile (012) 394 2401 or e-mail at Elias@thedti.gov.za for further details about the programme.

4 PROCESS TO SATISFY THE NIP OBLIGATION

4.1 Once the successful bidder (contractor) has made contact with and furnished the DTI with the information required, the following steps will be followed:

- a. the contractor and the DTI will determine the NIP obligation;
- b. the contractor and the DTI will sign the NIP obligation agreement;
- c. the contractor will submit a performance guarantee to the DTI;
- d. the contractor will submit a business concept for consideration and approval by the DTI;
- e. upon approval of the business concept by the DTI, the contractor will submit detailed business plans outlining the business concepts;
- f. the contractor will implement the business plans; and
- g. the contractor will submit bi-annual progress reports on approved plans to the DTI.

4.2 The NIP obligation agreement is between the DTI and the successful bidder (contractor) and, therefore, does not involve the purchasing institution.

Bid number	Closing date:
Name of bidder.....	
Postal address	
.....	
Signature.....	Name (in print).....
Date.....	

PREFERENCE POINTS CLAIM FORM IN TERMS OF THE PREFERENTIAL PROCUREMENT REGULATIONS 2022

This preference form must form part of all tenders invited. It contains general information and serves as a claim form for preference points for specific goals.

NB: BEFORE COMPLETING THIS FORM, TENDERERS MUST STUDY THE GENERAL CONDITIONS, DEFINITIONS AND DIRECTIVES APPLICABLE IN RESPECT OF THE TENDER AND PREFERENTIAL PROCUREMENT REGULATIONS, 2022.

1. GENERAL CONDITIONS

1.1 The following preference point systems are applicable to invitations to tender.

- the 80/20 system for requirements with a Rand value of up to R50 000 000 (all applicable taxes included); and
- the 90/10 system for requirements with a Rand value above R50 000 000 (all applicable taxes included).

1.2 To be completed by the organ of state:

- a) The applicable preference point system for this tender is the 90/10 preference point system.
- b) Either the 90/10 or 80/20 preference point system will be applicable in this tender. The lowest/ highest acceptable tender will be used to determine the accurate system once tenders are received.

1.3 Points for this tender (even in the case of a tender for income-generating contracts) shall be awarded for:

- (a) Price; and
- (b) Specific Goals.

1.4 To be completed by the organ of state:

The maximum points for this bid are allocated as follows:

	POINTS
PRICE	80 or 90
SPECIFIC GOALS	20 or 10
Total points for Price and Specific Goals must not exceed	100

1.5 Failure on the part of a tenderer to submit proof or documentation required in terms of this tender to claim points for specific goals with the tender, will be interpreted to mean that preference points for specific goals are not claimed.

1.6 The organ of state reserves the right to require of a tenderer, either before a tender is adjudicated or at any time subsequently, to substantiate any claim in regard to preferences, in any manner required by the organ of state.

2. DEFINITIONS

- (a) **“tender”** means a written offer in the form determined by an organ of state in response to an invitation to provide goods or services through price quotations, competitive tendering process or any other method envisaged in legislation;
- (b) **“price”** means an amount of money tendered for goods or services, and includes all applicable taxes less all unconditional discounts;
- (c) **“rand value”** means the total estimated value of a contract in Rand, calculated at the time of bid invitation, and includes all applicable taxes;
- (d) **“tender for income-generating contracts”** means a written offer in the form determined by an organ of state in response to an invitation for the origination of income-generating contracts through any method envisaged in legislation that will result in a legal agreement between the organ of state and a third party that produces revenue for the organ of state, and includes, but is not limited to, leasing and disposal of assets and concession contracts, excluding direct sales and disposal of assets through public auctions; and
- (e) **“the Act”** means the Preferential Procurement Policy Framework Act, 2000 (Act No. 5 of 2000).

3. FORMULAE FOR PROCUREMENT OF GOODS AND SERVICES

POINTS AWARDED FOR PRICE

3.1 THE 80/20 or 90/10 PREFERENCE POINT SYSTEMS

A maximum of 90 points is allocated for price on the following basis:

80/20 or 90/10

$$P_s = 80 \left(1 - \frac{P_t - P_{min}}{P_{min}} \right) \quad P_s = 90 \left(1 - \frac{P_t - P_{min}}{P_{min}} \right)$$

Where

- P_s = Points scored for price of tender under consideration
- P_t = Price of tender under consideration
- P_{min} = Price of lowest acceptable tender

4. POINTS AWARDED FOR SPECIFIC GOALS

- 4.1 In terms of Regulation 4(2); 5(2); 6(2) and 7(2) of the Preferential Procurement Regulations, preference points must be awarded for specific goals stated in the tender. For the purposes of this tender the tenderer will be allocated points based on the goals stated in table 1 below as may be supported by proof/ documentation stated in the conditions of this tender:
- 4.2 In cases where organs of state intend to use Regulation 3(2) of the Regulations, which states that, if it is unclear whether the 80/20 or 90/10 preference point system applies, an organ of state must, in the tender documents, stipulate in the case of—
 - (a) an invitation for tender for income-generating contracts, that either the 80/20 or 90/10 preference point system will apply and that the highest acceptable tender will be used to determine the applicable preference point system; or
 - (b) any other invitation for tender, that either the 80/20 or 90/10 preference point system will apply and that the lowest acceptable tender will be used to determine the applicable preference point system,then the organ of state must indicate the points allocated for specific goals for both the 90/10 and 80/20 preference point system.

Table 1: Specific goals for the tender and points claimed are indicated per the table below.

Note to tenderers: The tenderer must indicate how they claim points for each preference point system.)

The specific goals allocated points in terms of this tender	Number of points allocated (90/10 system) (To be completed by the organ of state)	Number of points allocated (80/20 system) (To be completed by the organ of state)	Number of points claimed (90/10 system) (To be completed by the tenderer)	Number of points claimed (80/20 system) (To be completed by the tenderer)
1. A Tenderer who is at least 51% owned by	Max points = 6 points	Max points = 12 points		
a) Black people	3 point	6 points		
b) Black people who are youth	1 point	2 points		
c) Black people who are women	1 point	2 points		
d) Black people with disabilities	1 point	2 points		
2. Promotion of Tenderer's located in a Specific Area	Max points = 2 points	Max points = 4 points		
For CIDB grade 7 and above work: Operating business address located within the Province (If tenderer is a JV, point will be earned by any partner in the Province)	2 points	4 points		
3. The creation of new jobs or the intensification of labour absorption	Max points = 2 points	Max points = 4 points		

DECLARATION WITH REGARD TO COMPANY/FIRM

4.3 Name of company/firm.....

4.4 Company registration number:

4.5 TYPE OF COMPANY/ FIRM

- Partnership/Joint Venture / Consortium
 - One-person business/sole propriety
 - Close corporation
 - Public Company
 - Personal Liability Company
 - (Pty) Limited
 - Non-Profit Company
 - State Owned Company
- [TICK APPLICABLE BOX]

4.6 I, the undersigned, who is duly authorised to do so on behalf of the company/firm, certify that the points claimed, based on the specific goals as advised in the tender, qualifies the company/ firm for the preference(s) shown and I acknowledge that:

- i) The information furnished is true and correct;
- ii) The preference points claimed are in accordance with the General Conditions as indicated in paragraph 1 of this form;
- iii) In the event of a contract being awarded as a result of points claimed as shown in paragraphs 1.4 and 4.2, the contractor may be required to furnish documentary proof to the satisfaction of the organ of state that the claims are correct;
- iv) If the specific goals have been claimed or obtained on a fraudulent basis or any of the conditions of contract have not been fulfilled, the organ of state may, in addition to any other remedy it may have –
 - (a) disqualify the person from the tendering process;
 - (b) recover costs, losses or damages it has incurred or suffered as a result of that person's conduct;
 - (c) cancel the contract and claim any damages which it has suffered as a result of having to make less favourable arrangements due to such cancellation;

- (d) recommend that the tenderer or contractor, its shareholders and directors, or only the shareholders and directors who acted on a fraudulent basis, be restricted from obtaining business from any organ of state for a period not exceeding 10 years, after the *audi alteram partem* (hear the other side) rule has been applied; and
- (e) forward the matter for criminal prosecution, if deemed necessary.

..... SIGNATURE(S) OF TENDERER(S)	
SURNAME AND NAME:
DATE:
ADDRESS:

B-BBEE EXEMPTED AFFIDAVIT FOR EXEMPTED MICRO ENTERPRISES

I, the undersigned,

Full name & Surname	
Identity number	

Hereby declare under oath as follows:

1. The contents of this statement are to the best of my knowledge a true reflection of the facts.
2. I am a member / director / owner of the following enterprise and am duly authorised to act on its behalf:

Enterprise Name			
Trading Name (If Applicable):			
Registration Number			
Enterprise Physical Address:			
Type of Entity (CC, (Pty) Ltd, Sole Prop etc.):			
Nature of Business:	BEP (Built Environment Professional)	Contractor	Supplier
Definition of "Black People"	<p>As per the Broad-Based Black Economic Empowerment Act 53 of 2003 as Amended by Act No 46 of 2013 "Black People" is a generic term which means Africans, Coloureds and Indians –</p> <p>(a) who are citizens of the Republic of South Africa by birth or descent; or</p> <p>(b) who became citizens of the Republic of South Africa by naturalisation-</p> <p>I. before 27 April 1994; or</p> <p>II. on or after 27 April 1994 and who would have been entitled to acquire citizenship by naturalization prior to that date;"</p>		
Definition of "Black Designated Groups"	<p>"Black Designated Groups" means:</p> <p>(a) unemployed black people not attending and not required by law to attend an educational institution and not awaiting admission to an educational institution;</p> <p>(b) Black people who are youth as defined in the National Youth Commission Act of 1996;</p> <p>(c) Black people who are persons with disabilities as defined in the Code of Good Practice on employment of people with disabilities issued under the Employment Equity Act;</p> <p>(d) Black people living in rural and under developed areas;</p> <p>(e) Black military veterans who qualifies to be called a military veteran in terms of the Military Veterans Act 18 of 2011;"</p>		

Construction Sector Affidavit

3. I hereby declare under Oath that:

- The Enterprise is _____% Black Owned as per Amended Code Series 100 of the amended Codes of Good Practice issued under section 9 (1) of B-BBEE Act No 53 of 2003 as amended by Act No 46 of 2013,
- The Enterprise is _____% Black Female Owned as per Amended Code Series 100 of the Amended Codes of Good Practice issued under section 9 (1) of B-BBEE Act No 53 of 2003 as Amended by Act No 46 of 2013,
- The Enterprise is _____% Black Designated Group Owned as per Amended Code Series 100 of the Amended Codes of Good Practice issued under section 9 (1) of B-BBEE Act No 53 of 2003 as Amended by Act No 46 of 2013,
- Black Designated Group Owned % Breakdown as per the definition stated above:
 - Black Youth % = _____%
 - Black Disabled % = _____%
 - Black Unemployed % = _____%
 - Black People living in Rural areas % = _____%
 - Black Military Veterans % = _____%

BEP	R1.8 million	
Contractor	R3.0 million	
Supplier	R3.0 million	

If the turnover exceeds the applicable amount in the table above then this affidavit is no longer applicable and an EME certificate must be obtained from a rating agency accredited by SANAS or when applicable a B-BBEE Verification Professional Regulator appointed by the Minister of Trade and Industry.

- Based on the Financial Statements/Management Accounts and other information available on the latest financial year-end of ___/___/_____, (dd/mm/yyyy) the annual Total Revenue was R3,000,000.00 (3 Million Rands) or less
- Please Confirm on the below table the B-BBEE Level Contributor, **by ticking the applicable box.**

100% Black Owned	Level One (135% B-BBEE procurement recognition level)	
At least 51% Black Owned	Level Two (125% B-BBEE procurement recognition level)	
At least 30% Black Owned	Level Four (100% B-BBEE procurement recognition level)	
Less than 30% Black Owned	Level Five (80% B-BBEE procurement recognition level)	

- 4. I know and understand the contents of this affidavit and I have no objection to take the prescribed oath and consider the oath binding on my conscience and on the Owners of the Enterprise, which I represent in this matter.
- 5. The sworn affidavit will be valid for a period of 12 months from the date signed by commissioner.

Stamp

Deponent Signature: _____

Date: ____/____/_____

Signature of Commissioner of Oaths

FAILURE TO FULLY COMPLETE DATE AND SIGN THIS FORM WILL RESULTS TO NON-AWARD OF POINTS

E. B-BBEE STATUS LEVEL VERIFICATION CERTIFICATE

Notes to tenderer:

1. The tenderer shall submit proof of B-BBEE Status Level of Contributor by submitting a copy of a valid B-BBEE Verification Certificate issued in accordance with the Amended Construction Sector Code published in Notice 931 of 2017 of Government Gazette No. 41287 of 1 December 2017.
2. The certificate shall:
 - (i) have been issued by a verification agency accredited by the South African National Accreditation System (SANAS); or
 - (ii) in the case of an Exempted Micro Enterprise (EME) with a total annual revenue of R3 million and less, be in the form of a sworn affidavit, in respect of their ownership and annual turnover, for the year ending not earlier than 12 (twelve) months prior to the tender closing date; and
 - (iii) have a date of issue not earlier than 12 (twelve) months prior to the tender closing date.
3. A consortium or joint venture (including unincorporated consortia and joint ventures) must submit a consolidated B-BBEE Status Level Verification Certificate. In addition, the consolidated B-BBEE Status Level Verification Certificate for unincorporated joint ventures shall only be applicable to this project (Tender No. to be indicated on the certificate).
4. An enterprise will qualify as an Exempted Micro Enterprise (EME) if it has a total annual revenue of R3 million or less, and is deemed to have the following B-BBEE Status in accordance with their black ownership levels:
 - (i) if less than 30% Black Owned then “**Level Five Contributor**”;
 - (ii) if at least 30% Black Owned but less than 51% Black Owned then “**Level Four Contributor**”;
 - (iii) if at least 51% Black Owned but less than 100% Black Owned, then “**Level Two Contributor**”;
 - (iv) if 100% Black Owned then “**Level One Contributor**”.
5. Tenderers are advised that any misrepresentation in the affidavits is a criminal offence.

F. CERTIFICATE OF AUTHORITY FOR SIGNATORY

The Tenderer must indicate the enterprise status by ticking the appropriate box hereunder.

(I) SOLE PROPRIETOR	(II) CLOSE CORPORATION	(III) PARTNERSHIP	(IV) COMPANY	(V) JOINT VENTURE / CONSORTIUM	
				Incorporated	
				Unincorporated	

Note:

The following document (**not older than date of advert of this tender**) must be attached to this form according to the status of the enterprise, in the form of a resolution authorising the signatory to sign all documents and any contract resulting therefrom on behalf of the enterprise, and **such resolution shall include a specimen signature of the signatory.**

Cooperative: 'Resolution of the Members'
 Close Corporation: 'Resolution of the Members'
 Company: 'Resolution of the Board' signed by the chairperson
 Joint Venture / Consortium: 'Resolution/agreement passed/reached' signed by the authorised representatives of the enterprises

MEMBERS RESOLUTION

CONTRACT NO. ZNB.....
.....
.....

Close Corporation / Company / Partnership / Trust /Sole proprietor or sole trader Name: _____ Registration
Number: _____ RESOLUTION OF THE

DIRECTORS OF THE COMPANY etc RESOLVED that
_____, in his/her capacity as _____,
_____ is authorised to make applications on behalf of
the Close Corporation / Company / Partnership / Trust /Sole proprietor or sole trader for: any documentation
relating to the business (which is not necessarily a change of ownership). The nominated person will also
have access to webpage for the business.

Signature(s) for Close Corporation / Company / Partnership / Trust/ Sole proprietor or sole trader.
(sole member still must sign this resolution)

Signature of members:

Name	Signature	Date
1. _____	_____	_____
2. _____	_____	_____
3. _____	_____	_____
4. _____	_____	_____
5. _____	_____	_____
6. _____	_____	_____

Specimen signature of the signatory:- _____

Failure to complete, sign and date the relevant certificate(s) set out hereafter or failure to provide the certificate(s) in the form of a resolution as described above shall result in the tender being considered non-responsive and rejected in terms of clause C.3.8.1 of the Conditions of Tender.

G. CONSTRUCTION EXPERIENCE

The following is a statement of work of similar nature recently successfully executed by myself / ourselves:

EMPLOYER: CONTACT PERSON AND TELEPHONE NUMBER	EMPLOYER'S AGENT: CONTACT PERSON AND TELEPHONE NUMBER	NATURE OF WORK	VALUE OF WORK (inclusive of VAT)	DATE COMPLETED OR EXPECTED TO BE COMPLETED

Attach additional pages if more space is required

SIGNATURE:

DATE:

(Of person authorised to sign on behalf of the Tenderer)

H. KEY PERSONNEL

H1. KEY PERSONNEL - MANAGEMENT

The Tenderer must insert in the spaces provided below a list of the key personnel to be employed in the management of the construction of the Works, together with a resume of their experience with particular reference to the construction of similar Works.

The Tenderer shall attach the curriculum vitae of the listed key management personnel to the page included below for this purpose.

DESIGNATION	NAME	PROJECT TYPE	VALUE OF WORK	YEAR COMPLETED
CONTRACTS MANAGER				
CONSTRUCTION MANAGER				
FOREMAN/				
SUPERVISOR				

Attach additional pages if more space is required

SIGNATURE:
 (Of person authorised to sign on behalf of the Tenderer)

DATE:

H2. KEY PERSONNEL – LABOUR ENHANCED ACTIVITIES (applicable to LIC projects and projects with labour enhancement activities)

Contractors shall employ in labour-enhanced works only those supervisory and management staff that have completed the required Skills Programme in terms of Appendix C of the “Guidelines for the implementation of labour-enhanced infrastructure projects under the Expanded Public Works Programme (EPWP) Third Edition 2015”:

- Foremen / Supervisors at NQF level 4 “National Certificate: Supervision of Civil Engineering Construction Processes”;
- Site Agent / Construction Manager at NQF level 5 "Manage Labour-Intensive Construction Processes" or equivalent Quality Council for Trades and Occupations (QCTO) qualifications at NQF level 5 or 7.

Tenderers’ attention is drawn to the required minimum supervisor to worker ratio for this project stated in clause F2.3 of Part F of the Particular Specifications.

The Tenderer must insert in the spaces provided below the relevant details of the personnel to be employed in the construction of the Works possessing the required qualifications in the supervision or management of LIC projects. A copy of the relevant qualification certificate for each such person shall be attached to the next page below.

DESIGNATION	NAME	NAME OF TRAINING INSTITUTION	QUALIFICATION OBTAINED IN THE SUPERVISION OR MANAGEMENT OF LIC PROJECTS	YEAR QUALIFICATION OBTAINED

Attach additional pages if more space is required

SIGNATURE:

DATE:

(Of person authorised to sign on behalf of the Tenderer)

Failure to list the names, designations, relevant qualification certificates and CV’s of the key personnel for Labour Enhanced Activities will result in tender being evaluated as non-responsive

CURRICULUM VITAE OF KEY PERSONNEL - MANAGEMENT

Refer to H1.

Curriculum Vitae of key management personnel to be attached to this page.

I. CONSTRUCTION EQUIPMENT

The following are lists of major construction equipment that I / we presently own or will acquire for this contract if my / our tender is accepted.

(a) Details of major construction equipment owned by me / us:

DESCRIPTION (<i>type, size and capacity</i>)	QUANTITY	YEAR OF MANUFACTURE

Attach additional pages if more space is required

(b) Details of major construction equipment that will be acquired:

DESCRIPTION (<i>type, size and capacity</i>)	QUANTITY	HOW ACQUIRED	
		HIRE / BUY	SOURCE

Attach additional pages if more space is required

SIGNATURE:

DATE:

(of person authorised to sign on behalf of the Tenderer)

J. PROPOSED SUBCONTRACTORS

I/We hereby notify you that it is my/our intention to employ the following subcontractors for work under this contract. If I/we am/are awarded a contract I/we agree that this notification does not change the requirement for me/us to submit the names of proposed subcontractors in accordance with the requirements of the contract for such appointments.

Acceptance of this tender shall not be construed as approval of any or all of the listed subcontractors. Should any or all of the subcontractors not be approved subsequent to the acceptance of the tender, it shall in no way invalidate this tender, and the tendered unit rates for the various items of work shall remain final and binding, even in the event of a subcontractor not listed below being approved by the Employer.

NAME OF SUBCONTRACTOR	CSD NUMBER	DESIGNATED GROUP AND OWNERSHIP %	B-BBEE LEVEL	NATURE OF WORK	PERCENTAGE TO BE SUBCONTRACTED

Attach additional pages if more space is required.

NB: The subcontractors listed above will not contribute to the achievements of the objectives specified in Section C3.3 Part G of this tender document.

SIGNATURE:

DATE:

(Of person authorised to sign on behalf of the Tenderer)

K. PARTICIPATION IN JOB CREATION USING LOCAL LABOUR

The Tenderer shall be required to participate in job creation (employment of local labour) by executing various portions of the Works using local labour (unskilled or semi-skilled), recruited from the local community, who are South African Citizens or foreigners in possession of a work visa issued by the Department of Home Affairs (only one such foreigner may be employed on any project). Proof of citizenship or work visa may be audited during the contract period.

The creation of one job shall mean the employment, for any period of time, of one such unskilled or semi-skilled labourer from the local community.

The Tenderer shall note the requirements for Job Creation Reporting for EPWP as set out in Part F: Expanded Public Works Programme (EPWP) of the project specifications.

The number of jobs to be created using such local labour is inclusive of the local labour employed to execute various portions of the Works by both the main Contractor and any subcontractors, including the small development subcontractors in terms of Part G: Small Contractor Development of the project specifications.

The number of jobs to be created using such local labour shall include for a minimum percentage allocation to the following individual targeted groups:

- 60% Women;
- 55% Youth; and
- 2% Disabled.

The minimum required content of such local labour for this project shall be calculated as follows:

$$\begin{aligned} & \text{Minimum required content of such local labour (\%)} \\ = & \frac{(100 \times \text{amount spent on wages for such local labour (excluding VAT)})}{(\text{Subtotal 1* (excluding contingencies, contract price adjustment and VAT)})} \end{aligned}$$

**Subtotal 1 is obtained from the Tender Summary under C2.2 Bill of Quantities*

The minimum required content of such local labour for this project shall be **6.38%** of the construction value.

For purposes of completing the table on the next page containing the Tenderer's declaration with respect to participation in job creation using local labour, the value of Subtotal 1* (excluding contingencies, contract price adjustment and VAT) which is obtained from the Tender Summary under C2.2 Bill of Quantities, shall be used.

TENDERER’S DECLARATION WITH RESPECT TO PARTICIPATION IN JOB CREATION USING LOCAL LABOUR:

The Tenderer shall complete the table below reflecting the anticipated local labour force to be employed on this contract, including such local labour employed by subcontractors.

I/We hereby tender to participate in job creation through the employment of local labour by creating the following number of jobs using unskilled or semi-skilled labourers, recruited from the local community, who are South African Citizens or foreigners in possession of a work visa issued by the Department of Home Affairs (only one such foreigner may be employed on any project), including for a minimum allocation of 60% Women, 55% Youth and 2% Disabled:

Local labour comprising unskilled or semi-skilled labourers recruited from the local community	Anticipated number of jobs to be created	Total number of person-days anticipated	Wage rate per person-day (excluding VAT) (Rand)	Total wage cost (excluding VAT) (Rand)
Contractor’s local labour content				
Subcontractors’ local labour content				
Total anticipated wage cost of local labour content (excluding VAT)				R
Subtotal 1* (excluding contingencies, contract price adjustment and VAT)				R
Hence anticipated local labour content expressed as a percentage of Subtotal 1* (excluding contingencies, contract price adjustment and VAT))				%
<i>Note: Should this percentage not equal or exceed the specified minimum percentage, the Tender will be considered non-responsive in terms of subclause C.3.8 of the Conditions of Tender and such a tender shall be rejected.</i>				
Specified minimum local labour content				6.38%

A penalty shall be applied to any shortfall in the local labour content achieved when measured against the specified minimum local labour content, as set out in Part F: Expanded Public Works Programme (EPWP) of the project specifications. The penalty shall not apply to shortfalls in the allocations to the individual target groups (i.e., Women/Youth/Disabled), only to shortfalls in the total local labour content achieved.

The undersigned, who warrants that he/she is duly authorized to do so on behalf of the Tenderer, confirms that he/she understands the conditions for such participation and confirms that the tender satisfies the conditions for participation in job creation through the employment of local labour.

Name:

Duly authorized to sign on behalf of:

SIGNATURE:

DATE:

(Of person authorised to sign on behalf of the Tenderer)

Failure to complete, sign and date this form shall result in the tender being considered non-responsive and rejected in terms of clause C.3.8 of the Conditions of Tender.

L. BIDDERS HEALTH AND SAFETY DECLARATION

In terms of Regulation 5(1)(h) of the OHS Act 1993 Construction Regulations 2014 (referred to as 'the Regulations' hereafter), a Contractor may only be appointed to perform construction work if the Employer is satisfied that the Contractor has the necessary competencies and resources to carry out the work safely in accordance with the Occupational Health and Safety Act No 85 of 1993, as amended and the OHS Act 1993 Construction Regulations 2014.

To that effect a person duly authorised by the Tenderer must complete and sign the declaration hereafter in detail.

Declaration by Tenderer

1. I, the undersigned, hereby declare and confirm that I am fully conversant with the Occupational Health and Safety Act No. 85 of 1993 (as amended by the Occupational Health and Safety Amendment Act No. 181 of 1993), and the OHS Act 1993 Construction Regulations 2014.
2. I hereby declare that my company has the competence and the necessary resources to safely carry out the construction work under this contract in compliance with the Construction Regulations and the Employer's Health and Safety Specification.
3. I propose to achieve compliance with the Regulations by one of the following:
 - (a) From my own competent resources as detailed in 4(a) hereafter: ***Yes / No**
 - (b) From my own resources or still to be appointed, and trained until competency is achieved, as detailed in 4(b) hereafter: ***Yes / No**
 - (c) From outside sources by appointment of competent specialist subcontractors as detailed in 4(c) hereafter: ***Yes / No**

(* = delete whatever is not applicable)

4. Details of resources I propose:

Note: Competent resources shall include safety personnel such as the construction manager, construction health and safety officer and construction supervisor as defined in Regulation 8, and competent persons as defined in the OHS Act 1993 Construction Regulations 2014, as applicable to this contract.

- (a) Details of the competent and qualified key persons from my company's own resources, who will form part of the contract team:

NAME OF COMPETENT PERSONS	POSITION TO BE FILLED BY COMPETENT PERSONS

- (b) Details of training of persons from my company's own resources (or to be hired) who still have to be trained to achieve the necessary competency:
 - (i) By whom will training be provided?
 - (ii) When will training be undertaken?
 - (iii) List the positions to be filled by persons to be trained or hired:
- (c) Details of competent resources to be appointed as subcontractors if competent persons cannot be supplied from own company:

Name of proposed subcontractor:

Qualifications or details of competency of the subcontractor:

.....
.....

- 5. I hereby undertake, if my tender is accepted, to provide, before commencement of the works under the contract, a suitable, sufficiently documented, and coherent site-specific Health and Safety Plan in accordance with Regulation 7(1) (a) of the Construction Regulations, which plan shall be subject to approval by the Employer.
- 6. I confirm that copies of my company's approved Health and Safety Plan, the Employer's Health and Safety Specification as well as the OHSA 1993 Construction Regulations 2014 will be provided on site and will at all times be available for inspection by the Contractor's personnel, the Employer's personnel, the Employer's Agent, Construction Health and Safety Agent, visitors, and officials and inspectors of the Department of Labour.
- 7. I hereby confirm that adequate provision has been made in my tendered rates and prices in the schedule of quantities to cover the cost of all resources, actions, training and all health and safety measures envisaged in the OHSA 1993 Construction Regulations 2014, and that I will be liable for any penalties that may be applied in terms of the said Regulations (Regulation 33) as a result of contravening or failing to comply with the provisions of the Act and the Regulations.
- 8. I agree that my failure to complete and execute this declaration to the satisfaction of the Employer will mean that I am unable to comply with the requirements of the OHSA 1993 Construction Regulations 2014, and accept that my tender will be prejudiced and may be rejected at the discretion of the Employer.

SIGNATURE:

DATE:

(of person authorised to sign on behalf of the Tenderer)

M. DEVIATIONS AND QUALIFICATIONS

Should the Tenderer wish to make any deviation from or any qualification to the Special Conditions of Contract, Specifications, Bill of Quantities, or Drawings, or should he wish to qualify the tender in any way, he shall indicate the proposals clearly hereunder or alternatively on photocopies of the original tender documentation which shall be attached to this page.

Please note: The extent of deviations from the tender documents issued by the Employer prior to the tender closing date is limited to those permissible in terms of the Conditions of Tender. Please also refer to Returnable Schedule N.

SECTION	PAGE	DEVIATION OR QUALIFICATION, INCLUDING REFERENCE CLAUSE OR ITEM NUMBER

Attach additional pages if more space is required

SIGNATURE:

DATE:

(Of person authorised to sign on behalf of the Tenderer)

N. SCHEDULE OF ALTERNATIVE TENDERS

The attention of tenderers is specifically drawn to clause C.2.12 Alternative tender offers of Annex C Standard Conditions of Tender and to clause C.2.12 of section T1.2 TENDER DATA in this project document.

An alternative tender offer or design shall be considered only if the main tender offer has also been submitted in accordance with the requirements of clauses C.2.12.1 and C.2.12.2 of Annex C and such main tender offer is the winning tender as stated in clause C.2.12.3 of Annex C.

The requirements for alternative offers are as described in **clause A2.1.4.2‘ALTERNATIVE DESIGNS’** of the **‘COTO Standard Specifications for Road and Bridge Works for South African Road Authorities (Draft Standard) (October 2020 edition)’**.

Such alternative offers shall be described, measured and priced in sufficient detail to enable the Employer to evaluate the alternative. The Tenderer shall set out the proposal clearly hereunder or alternatively on photocopies of the original tender documentation which shall be attached to this page.

SECTION	PAGE	ALTERNATIVE OFFER, INCLUDING REFERENCE CLAUSE OR ITEM NUMBER

SIGNATURE:

DATE:

(Of person authorised to sign on behalf of the Tenderer)

O. TECHNICAL PROPOSAL (Only applicable to complex work and Specialist work)

The tenderer is required to submit a technical proposal which covers the following criteria.

O1. Experience of key personnel

The experience of assigned staff member in relation to the scope of work will be evaluated from three different points of view:

- 1) General experience (total duration of professional activity), level of education and training and positions held of each discipline specific team leader.
- 2) The education, training, skills and experience of the Assigned Staff in the specific sector, field, subject, etc which is directly linked to the scope of work.
- 3) The key staff members' / experts' knowledge of issues which the tenderer considers pertinent to the project e.g. local conditions, affected communities, legislation, techniques etc.

A CV of the Contracts Manager, Construction Manager and Foremen should be attached to this schedule:

Each CV should be structured under the following headings:

- 1 Personal particulars
 - name
 - date and place of birth
 - place (s) of tertiary education and dates associated therewith
 - professional awards
- 2 Qualifications (degrees, diplomas, grades of membership of professional societies and professional registrations)
- 3 Skills
- 4 Name of current employer and position in enterprise
- 5 Overview of post graduate / diploma experience (year, organization and position)
- 6 Outline of recent assignments / experience that has a bearing on the scope of work

The undersigned, who warrants that he / she is duly authorised to do so on behalf of the enterprise, confirms that the contents of this schedule are within my personal knowledge and are to the best of my belief both true and correct.

Signed

Date

Name

Position

O2. Tenderer's Road and Bridge Maintenance including structures.

List number of completed Road Rehabilitation/Reseal projects.

The evaluation will consider the nature of the reference projects, scope of services provided, and Employer completion certificate.

Final Approval Certificates/ Completion Certificates not older than 15 years per project to be provided with contact details of references.

The undersigned, who warrants that he / she is duly authorised to do so on behalf of the enterprise, confirms that the contents of this schedule are within my personal knowledge and are to the best of my belief both true and correct.

Signed: Date:

Name: Position:

Not Applicable

P. NOTICES TO TENDERERS REGARDING THE COMPLETION OF FORMS

PLEASE NOTE THAT THIS TENDER IS SUBJECT TO TREASURY REGULATIONS 16A ISSUED IN TERMS OF THE PUBLIC FINANCE MANAGEMENT ACT, 1999, THE KWAZULU-NATAL SUPPLY CHAIN MANAGEMENT POLICY FRAMEWORK AND THE GENERAL CONDITIONS OF CONTRACT.

1. Unless inconsistent with or expressly indicated otherwise by the context, the singular shall include the plural and vice versa and with words importing the masculine gender shall include the feminine and the neuter.
2. Under no circumstances whatsoever may the tender forms be retyped or redrafted. Photocopies of the original tender documentation may be used, but an original signature must appear on such photocopies.
3. The tenderer is advised to check the number of pages and to satisfy himself that none are missing or duplicated.
4. Tender submitted must be complete in all respects.
5. Tender shall be lodged at the address indicated not later than the closing time specified for their receipt, and in accordance with the directives in the tender documents.
6. Each tender shall be addressed in accordance with the directives in the tender documents and shall be lodged in a separate sealed envelope, with the name and address of the tenderer, the tender number and closing date indicated on the envelope. The envelope shall not contain documents relating to any tender other than that shown on the envelope. If this provision is not complied with, such tender may be rejected as being invalid.
7. All tenders received in sealed envelopes with the relevant tender numbers on the envelopes are kept unopened in safe custody until the closing time of the tender. Where, however, a tender is received open, it shall be sealed. If it is received without a tender number on the envelope, it shall be opened, the tender number ascertained, the envelope sealed, and the tender number written on the envelope.
8. A specific box is provided for the receipt of tenders, and no tender found in any other box or elsewhere after the closing date and time of tender will be considered.
9. No tender sent through the post will be considered if it is received after the closing date and time stipulated in the tender documentation, and proof of posting will not be accepted as proof of delivery.
10. No tender submitted by telefax, telegraphic or other electronic means will be considered.
11. Tender documents must not be included in packages containing samples. Such tenders may be rejected as being invalid.
12. Any alteration made by the tenderer must be initialled. If not initialled the tenderer may be disqualified.
13. Use of correcting fluid is prohibited
14. Tenders documents will be opened in public as soon as practicable after the closing time of tender.
15. Where practical, prices are made public at the time of opening tender documents.

Q. ACCEPTABLE PROOF, RIGHT TO AWARD & PRICE NEGOTIATION

a) Acceptable Proof for the allocation of Specific Goals Points

The specific goals allocated points in terms of this tender	Acceptable Proof for Allocation of Points
1. A tenderer who is at least 51% owned by a) black people b) black people who are youth c) black people who are women d) black people with disabilities	CIPC company registration documents and CSD report and BBB-EE Certificate or Sworn affidavit and a Letter form a Doctor certified by the Department of Health Occupational Doctor confirming the disability.
2. Promotion of Tenderer's located in a Specific Area	
For CIDB grade 7 and above work: Operating business address located within the KZN Province (If tenderer is a JV, point will be earned by any partner in the province)	
	CIPC company registration documents
3. The creation of new jobs or the intensification of labour absorption	Proof of participation on job creation as per the returnable schedule K must be at least 2 % above the Specified minimum local labour content. Zero points will be awarded if not at least 2% above the target.

b) Rights to Award

- KwaZulu-Natal Department of Transport reserves the right to call for presentations from shortlisted suppliers or **“Reserves the Right to accept bid In Whole or In Part.”**
- Not to make any award in this bid or accept any tender submitted,
- Request further technical information from any tenderer after the closing date,
- Verify information and documentation of the tenderer(s),
- Not to accept any of the tender proposals submitted,
- To withdraw or amend any of the tender conditions by notice in writing to all tenderer prior to closing of the bid and post award, and
- If an incorrect award has been made to remedy the matter in any lawful manner it may deem fit.

c) Price Negotiation at quotation stage.

KwaZulu-Natal Department of Transport reserves the right to negotiate with the shortlisted tenderer prior and/or post award.

The terms and conditions for negotiations will be communicated to the shortlisted tenderers prior to invitation to negotiations.

The negotiation terms and conditions may include presentations and/or site visits. This phase is meant to ensure the conditions of tender and projects will be implementable.

KwaZulu-Natal Department of Transport supports the spirit of economic empowerment and recognizes that real empowerment can only be achieved through individuals and businesses conducting themselves in accordance with the Constitution and in an honest, fair, equitable, transparent and

legally compliant manner. Against this background the KwaZulu-Natal Department of Transport does not support any form of fronting.

CONTRACT

PART C1: AGREEMENTS AND CONTRACT DATA

PART C2: PRICING DATA

PART C3: SCOPE OF WORK

PART C4: SITE INFORMATION

CONTRACT

TABLE OF CONTENTS	Page	Colour
PART C1: AGREEMENTS AND CONTRACT DATA		
C1.1: FORM OF OFFER AND ACCEPTANCE	C3	Yellow
C1.1.1: OFFER	C3	Yellow
C1.1.2: ACCEPTANCE.....	C4	Yellow
C1.1.3: SCHEDULE OF DEVIATIONS	C5	Yellow
C1.2: CONTRACT DATA	C7	Yellow
C1.2.1: CONDITIONS OF CONTRACT	C7	Yellow
C1.2.2: DATA PROVIDED BY THE EMPLOYER	C10	Yellow
C1.2.3: DATA PROVIDED BY THE CONTRACTOR.....	C16	Yellow
C1.3: PERFORMANCE GUARANTEE.....	C17	White
C1.4: AGREEMENT IN TERMS OF SECTION 37(2) OF THE OCCUPATIONAL HEALTH AND SAFETY ACT NO. 85 OF 1993.....	C20	White
C1.5: RETENTION MONEY GUARANTEE	C22	White
C1.6: TRANSFER OF RIGHTS.....	C24	White
PART C2: PRICING DATA		
C2.1: PRICING ASSUMPTIONS	C25	Yellow
C2.2: BILL OF QUANTITIES.....	C30	Yellow
PART C3: SCOPE OF WORK		
TABLE OF CONTENTS.....	C56	Blue
C3.1: STANDARD SPECIFICATIONS	C57	Blue
C3.2: PROJECT SPECIFICATIONS.....	C58	Blue
C3.3: PARTICULAR SPECIFICATIONS	C89	Blue
PART C4: SITE INFORMATION		
TABLE OF CONTENTS.....	C203	Green
C4.1: LOCALITY PLAN.....	C204	Green
C4.2: EXAMPLE OF CONTRACT SIGNBOARD DETAILS	C205	Green
C4.3: EXISTING SERVICES REPORT.....	C207	Green
C4.4: CONDITIONS ON SITE: MATERIALS INFORMATION	C208	Green
C4.5: TRAFFIC INFORMATION	C210	Green
C4.6: STANDARD DETAILS	C215	Green
C4.7: ANY OTHER RELEVANT TECHNICAL REPORTS	C220	Green
ANNEXURE A: GUIDELINES FOR CONSTRUCTION AND MAINTENANCE PROJECTS DURING COVID-19 LOCKDOWN		
	C221	White

PART C1: AGREEMENTS AND CONTRACT DATA

C1.1: FORM OF OFFER AND ACCEPTANCE

C1.1.1: OFFER

The Employer, identified in the Acceptance signature block, has solicited offers to enter into a contract in respect of the following works:

CONTRACT NO. ZNB01307/00000/00/POR/INF/22/T: PROVISION OF MAINTENANCE ON VARIOUS PROVINCIAL ROADS OVER A PERIOD OF 36 MONTHS WITHIN UMZUMBE SOUTHERN ZONE 1 UNDER COST CENTRE PORT SHEPSTONE IN THE DURBAN REGION.

The Tenderer, identified in the Offer signature block below, has examined the documents listed in the Tender Data and addenda thereto as listed in the Tender Schedules, and by submitting this Offer has accepted the Conditions of Tender.

By the representative of the Tenderer, deemed to be duly authorised, signing this part of this Form of Offer and Acceptance, the Tenderer offers to perform all of the obligations and liabilities of the Contractor under the Contract including compliance with all its terms and conditions according to their true intent and meaning for an amount to be determined in accordance with the Conditions of Contract identified in the Contract Data.

The offered total of the prices inclusive of Value Added Tax is:

Amount in Words.....

.....

.....

R..... (in figures).

This Offer may be accepted by the Employer by signing the Acceptance part of this Form of Offer and Acceptance and returning one copy of this document to the Tenderer before the end of the period of validity stated in the Tender Data, whereupon the Tenderer becomes the party named as the Contractor in the Conditions of Contract identified in the Contract Data.

Signature: (of person authorised to sign the tender).....

Name: (of signatory in capitals).....

Capacity: (of signatory).....

Name of Tenderer: (organisation).....

Address:

.....

Telephone number: **E-mail:**

Witness:

Signature:

Name: (in capitals).....

Date:

[Failure of a Tenderer to sign this form will invalidate the tender]

This form is to be completed by the Employer only

C1.1.2: ACCEPTANCE

By signing this part of the Form of Offer and Acceptance, the Employer, identified below, accepts the Tenderer's Offer. In consideration thereof, the Employer shall pay the Contractor the amount due in accordance with the Conditions of Contract identified in the Contract Data. Acceptance of the Tenderer's Offer shall form an agreement between the Employer and the Tenderer upon the terms and conditions contained in this Agreement and in the Contract that is the subject of this Agreement.

The terms of the contract are contained in

- Part C1 Agreements and Contract Data (which includes this Agreement)
- Part C2 Pricing Data
- Part C3 Scope of Work
- Part C4 Site Information

And the schedules, forms, drawings and documents or parts thereof, which may be incorporated by reference into Parts C1 to C4 above.

Deviations from and amendments to the documents listed in the Tender Data and any addenda thereto listed in the Tender Schedules as well as any changes to the terms of the Offer agreed by the Tenderer and the Employer during this process of offer and acceptance, are contained in the Schedule of Deviations attached to and forming part of this Agreement. No amendments to or deviations from said documents are valid unless contained in this Schedule, which must be duly signed by the authorised representatives of both parties.

The Tenderer shall within two weeks after receiving a completed copy of this Agreement, including the Schedule of Deviations (if any), contact the Employer's Agent (whose details are given in the Contract Data) to arrange the delivery of any bonds, guarantees, proof of insurance and any other documentation to be provided in terms of the Conditions of Contract identified in the Contract Data at, or just after, the date this Agreement comes into effect. Failure to fulfil any of these obligations in accordance with those terms shall constitute a repudiation of this Agreement.

Notwithstanding anything contained herein, this Agreement comes into effect on the date when the Tenderer receives one fully completed original copy of this document, including the Schedule of Deviations (if any). Unless the Tenderer (now Contractor) within five days of the date of such receipt notifies the Employer in writing of any reason why he cannot accept the contents of this Agreement, this Agreement shall constitute a binding contract between the parties.

Signature:

Name: *(in capitals)*

Capacity:

Name of Employer: *(organisation)*

Address:

.....

Witness: Signature: **Name:** *(in capitals)*

Date:

any confirmation, clarification or change to the terms of the offer agreed by the Tenderer and the Employer during this process of offer and acceptance.

It is expressly agreed that no other matter whether in writing, oral communication or implied during the period between the issue of the tender documents and the receipt by the Tenderer of a completed signed copy of this Agreement shall have any meaning or effect in the contract between the parties arising from this Agreement.

FOR THE TENDERER:

Signature:

Name:

Capacity:

Tenderer: *(Name and address of organisation)*

.....

Witness:

Signature:

Name:

Date:

FOR THE EMPLOYER:

Signature:

Name:

Capacity:

Employer: *(Name and address of organisation)*

.....

Witness:

Signature:

Name:

Date:

C1.2: CONTRACT DATA

C1.2.1: CONDITIONS OF CONTRACT

C1.2.1.1 GENERAL CONDITIONS OF CONTRACT

This Contract will be based on the 'General Conditions of Contract for Construction Works, Third Edition (2015)', issued by the South African Institution of Civil Engineering (abbreviated title: 'GCC 2015').

It is agreed that the only variations from the GCC 2015 are those set out hereafter under "C1.2.1.2 SPECIAL CONDITIONS OF CONTRACT".

C1.2.1.2 SPECIAL CONDITIONS OF CONTRACT

C1.2.1.2.1 GENERAL

These Special Conditions of Contract (SCC) form an integral part of the Contract. The Special Conditions of Contract shall amplify, modify or supersede, as the case may be, the GCC 2015 to the extent specified below, and shall take precedence and shall govern.

The clauses of the Special Conditions of Contract hereafter are numbered "SCC" followed in each case by the number of the applicable clause or sub clause in the GCC 2015, and the applicable heading, or (where a new special condition that has no relation to the existing clauses is introduced) by a number that follows after the last clause number in the GCC 2015, and an appropriate heading.

C1.2.1.2.2 AMENDMENTS TO THE GCC 2015

SCC 1.1 Definitions

SCC 1.1.1.14: *delete* "Commencement Date" *in the definition and substitute* "date of commencement of the Works".

Add the following to the end of Clause 1.1:

"SCC 1.1.1.35 "Construction Manager" means the person approved of in writing by the Employer's Agent, as the Contractor's representative on Site.

SCC 1.1.1.36 "Targeted Enterprise" means an enterprise as defined in Part F: Small Contractor Development of section C3.3 Particular Specifications in Part C3: Scope of Work.

SCC 1.1.1.37 "Targeted Labour" means labour as defined in Part F: Small Contractor Development of section C3.3 Particular Specifications in Part C3: Scope of Work."

SCC 4.1.1 Extent of Contractor's obligations

Add the following new paragraphs to the end of Clause 4.1.1:

"If the Contractor fails to achieve the monetary value of the contract participation goal stated in the Contract Data for local labour content in terms of Part E: Expanded Public Works Programme of section C3.3 Particular Specifications in Part C3: Scope of Work, the Contractor shall be liable to the Employer for a sum calculated in accordance with the Contract Data and the aforementioned Scope of Work as a penalty for such underachievement.

If the Contractor fails to achieve the monetary value of the contract participation goal stated in the Contract Data for contract participation by Targeted Enterprises in terms of Part F: Small Contractor Development of section C3.3 Particular Specifications in Part C3: Scope of Work, the Contractor shall be liable to the Employer for a sum calculated in accordance with the Contract Data and the aforementioned Scope of Work as a penalty

for such underachievement.”

SCC 4.4.2 Subcontractor to be approved

Add the following to Clause 4.4.2:

“The Contractor shall comply with the subcontracting restrictions stated in the Contract Data.”

SCC 4.10.1 Engagement of employees

Add the following to Clause 4.10.1:

“The contractor shall pay rates and wages, and observe conditions of labour, which are not lower than those established for the trade or industry where the work is carried out, as stated in the Contract Data.”

SCC 5.3.1 Commencement of the Works

Delete the first sentence of Clause 5.3.1 and substitute the following:

“The Employer’s Agent shall give the Contractor not less than 7 days’ notice of the date of commencement of the Works on which date the Contractor is instructed to commence carrying out the Works, save as may be otherwise provided in the Contract, or be legally or physically impossible. The date of commencement of the Works shall be within the period after the Commencement Date stated in the Contract Data.”

SCC 5.3.3 Time to instruct commencement of the Works

Delete Clause 5.3.3.

SCC 5.14.4 Certification of Completion

Insert the following in the first sentence after the words “has been duly completed,”

“and the Contractor has submitted the information stated in the Contract Data,”

SCC 5.14.6 Occupation by the Employer

Add the following to Clause 5.14.6:

“The use of any completed roadway or parts of the Works, whether for unhindered use by the public or for accommodation of traffic, while other parts are being constructed, shall not constitute occupation of the Works by the Employer.”

SCC 6.2.1 Delivery of security

In the last two lines of Clause 6.2.1, delete the words “the type of security for the due performance of the Contract, as selected in the Contract Data” and replace them with the words “a fixed performance guarantee as security for the due performance of the Contract in accordance with the Contract Data Part A: Data Provided by the Employer”.

Delete the entirety of Clause 6.2.2 and replace it with the following:

“SCC 6.2.2 Contractor failing to provide security

If the Contractor fails to provide the required fixed performance guarantee within the time period stated in the Contract Data, or if the performance guarantee shall differ substantially from the pro forma, it shall legally be deemed that the Contractor has selected a security of ten per cent retention of the value of the Works without limiting the Employer’s right to terminate the Contract in terms of Clause 9.2.”

SCC 6.2.3 Validity of performance guarantee

Delete the entirety of the first sentence of Clause 6.2.3 and replace it with the following:

“The Contractor shall ensure that the performance guarantee remains valid and enforceable until the Certificate of Completion is issued.”

SCC 6.10.4 Delivery, dissatisfaction with and payment of payment certificate

Delete “within 28 days” in the third sentence and substitute “within 30 days”.

SCC 6.10.8 Contractor’s completion statement

Delete “within 28 days” in the third sentence and substitute “within 30 days”.

SCC 6.10.9 Final Payment Certificate

Delete “within 28 days” in the second sentence and substitute “within 30 days”.

SCC 10.1.5 Employer’s Agent’s ruling on Contractor’s Claim

Delete “within 28 days” in the first sentence and in Clause 10.1.5.1, and substitute “within 56 days”.

C1.2.2: DATA PROVIDED BY THE EMPLOYER

The following contract specific data are applicable to this contract.

CLAUSE	CONTRACT SPECIFIC DATA PROVIDED BY THE EMPLOYER																														
1.	GENERAL																														
1.1.1.13	<p>The Defects Liability Period is according to work types is:</p> <table border="1" style="width: 100%; border-collapse: collapse;"> <thead> <tr> <th style="text-align: left;">Item</th> <th style="text-align: center;">Months</th> </tr> </thead> <tbody> <tr><td>Pothole Patching</td><td style="text-align: center;">6</td></tr> <tr><td>Asphalt Surfacing and Overlays</td><td style="text-align: center;">12</td></tr> <tr><td>Guardrails</td><td style="text-align: center;">12</td></tr> <tr><td>Road Studs</td><td style="text-align: center;">12</td></tr> <tr><td>Line Markings</td><td style="text-align: center;">12</td></tr> <tr><td>Bridge Handrails</td><td style="text-align: center;">12</td></tr> <tr><td>Bridge Joints</td><td style="text-align: center;">12</td></tr> <tr><td>Concrete Kerb and Channel</td><td style="text-align: center;">12</td></tr> <tr><td>Concrete Open Drains</td><td style="text-align: center;">12</td></tr> <tr><td>Concrete Pavement</td><td style="text-align: center;">12</td></tr> <tr><td>Concrete Structures</td><td style="text-align: center;">12</td></tr> <tr><td>Pipe Culverts including Inlets and Outlets</td><td style="text-align: center;">12</td></tr> <tr><td>Earthworks</td><td style="text-align: center;">12</td></tr> <tr><td>Layerworks on surfaced roads</td><td style="text-align: center;">12</td></tr> </tbody> </table>	Item	Months	Pothole Patching	6	Asphalt Surfacing and Overlays	12	Guardrails	12	Road Studs	12	Line Markings	12	Bridge Handrails	12	Bridge Joints	12	Concrete Kerb and Channel	12	Concrete Open Drains	12	Concrete Pavement	12	Concrete Structures	12	Pipe Culverts including Inlets and Outlets	12	Earthworks	12	Layerworks on surfaced roads	12
Item	Months																														
Pothole Patching	6																														
Asphalt Surfacing and Overlays	12																														
Guardrails	12																														
Road Studs	12																														
Line Markings	12																														
Bridge Handrails	12																														
Bridge Joints	12																														
Concrete Kerb and Channel	12																														
Concrete Open Drains	12																														
Concrete Pavement	12																														
Concrete Structures	12																														
Pipe Culverts including Inlets and Outlets	12																														
Earthworks	12																														
Layerworks on surfaced roads	12																														
SCC 1.1.1.14	<p>The time for achieving Practical Completion is <u>36 months</u> from the date of commencement of the Works, including non-working days and special non-working days. This duration also includes the procurement of all contracts as part of the Indirect Targeting for Enterprise Development.</p>																														
1.1.1.26	<p>Pricing Strategy: The Contract is to be a Re-measurement Contract.</p>																														
1.1.1.15	<p>Name of Employer: Province of KwaZulu-Natal represented by Head of Department: Department of Transport</p>																														
1.2.1.2	<p>Address of Employer:</p> <table style="width: 100%; border: none;"> <tr> <td style="width: 50%; vertical-align: top;"> <p><u>Physical:</u> 05 Memorial Road Port Shepstone 4240 E-mail: moahloli.makoro@kzntransport.gov.za Telephone No: 039 688 4340</p> </td> <td style="width: 50%; vertical-align: top;"> <p><u>Postal:</u> Private Bag X825 Port Shepstone 4240 Fax No: 039 682 2622</p> </td> </tr> </table>	<p><u>Physical:</u> 05 Memorial Road Port Shepstone 4240 E-mail: moahloli.makoro@kzntransport.gov.za Telephone No: 039 688 4340</p>	<p><u>Postal:</u> Private Bag X825 Port Shepstone 4240 Fax No: 039 682 2622</p>																												
<p><u>Physical:</u> 05 Memorial Road Port Shepstone 4240 E-mail: moahloli.makoro@kzntransport.gov.za Telephone No: 039 688 4340</p>	<p><u>Postal:</u> Private Bag X825 Port Shepstone 4240 Fax No: 039 682 2622</p>																														
1.1.1.16	<p>Name of Employer's Agent: Province of KwaZulu-Natal represented by Head of Department: Department of Transport</p>																														
1.2.1.2	<p>Address of Employer's Agent:</p> <table style="width: 100%; border: none;"> <tr> <td style="width: 50%; vertical-align: top;"> <p><u>Physical:</u> 05 Memorial Road Port Shepstone 4240 E-mail: moahloli.makoro@kzntransport.gov.za Telephone No: 039 688 4340</p> </td> <td style="width: 50%; vertical-align: top;"> <p><u>Postal:</u> Private Bag X825 Port Shepstone 4240 Fax No: 039 682 2622</p> </td> </tr> </table>	<p><u>Physical:</u> 05 Memorial Road Port Shepstone 4240 E-mail: moahloli.makoro@kzntransport.gov.za Telephone No: 039 688 4340</p>	<p><u>Postal:</u> Private Bag X825 Port Shepstone 4240 Fax No: 039 682 2622</p>																												
<p><u>Physical:</u> 05 Memorial Road Port Shepstone 4240 E-mail: moahloli.makoro@kzntransport.gov.za Telephone No: 039 688 4340</p>	<p><u>Postal:</u> Private Bag X825 Port Shepstone 4240 Fax No: 039 682 2622</p>																														

CLAUSE	CONTRACT SPECIFIC DATA PROVIDED BY THE EMPLOYER
<p>3.</p> <p>3.2.3</p>	<p>EMPLOYER'S AGENT</p> <p>The Employer's Agent is required to obtain the specific approval of the Employer before executing any of his functions or duties according to the following Clauses:</p> <p>SCC 5.3.1: Give the Contractor notice of the commencement date of the Works.</p> <p>6.3.1: Order any work as a Variation Order.</p> <p>6.3.1: Order any work which requires the utilisation of the provision for contingencies in the Contract Sum.</p> <p>6.3.1: Order any work which requires the Contract Price to exceed the Contract Sum.</p> <p>10.1.5: Ruling on a Contractor's claim.</p>
<p>4.</p> <p>SCC 3.4.1.1</p> <p>SCC 4.4.2</p> <p>SCC 4.10.1</p>	<p>CONTRACTOR'S GENERAL OBLIGATIONS</p> <p>The contract participation goal for local labour content is minimum 6.38%</p> <p>The penalty for failing to achieve the monetary value of the above target set by the Employer for local labour content in terms of Part E: Expanded Public Works Programme of section C3.3 Particular Specifications in Part C3: Scope of Work, is 5% of the monetary value by which the achieved monetary value falls short of the target monetary value.</p> <p>The contract participation goal for Targeted Enterprises is <u>30%</u>.</p> <p>The successful tenderer must subcontract a minimum of 30% of the value of the Constructions Works to Targeted Enterprises through Contract Participation Goals (CPG) for a bidder that is BEE Level 1 EME or QSE that is more than 51% owned by black person(s) in terms of the requirements of the cidb B.U.I.L.D Programme with respect to Indirect Targeting for Enterprise Development. <i>(for projects that are R20 million and above)</i></p> <p>The implementation of the Indirect Targeting for Enterprise Development shall be as per PART F:SMALL CONTRACTOR DEVELOPMENT of section C3.3 Particular Specifications in Part C3: Scope of Work and the Standard for Indirect Targeting for Enterprise Development through Construction Works Contracts, Published in the Government Gazette No. 36190 of 29 January 2013, issued in terms of sections 5(2) of the Construction Industry Development Board Act, 2000(Act no. 38 of 2000).</p> <p>The penalty for failing to achieve the monetary value of the above target set by the Employer for contract participation by Targeted Enterprises in terms of Part F: Small Contractor Development of section C3.3 Particular Specifications in Part C3: Scope of Work, is 5% of the monetary value by which the achieved monetary value falls short of the target monetary value.</p> <p>The Contractor may not subcontract more than 25% of the value of the contract to any other enterprise that does not have an equal or higher B-BBEE status level of contributor than the Contractor, unless the contract is subcontracted to an EME that has the capability and ability to execute the subcontract.</p> <p>The Contractor and his subcontractors shall be registered with the Bargaining Council for the Civil Engineering Industry, and comply with the wage rates and conditions of labour agreed by the Bargaining Council for the Civil Engineering Industry, except where a specific industry publishes its own wage rates and conditions of labour.</p> <p>The wage rates and conditions of labour employed under the Expanded Public Works Programme, shall comply with the Ministerial Determination 4, issued in terms of the Basic Conditions of Employment Act of 1997 by the Minister of Labour in Government Notice No. R347 of 4 May 2012.</p>

CLAUSE	CONTRACT SPECIFIC DATA PROVIDED BY THE EMPLOYER
	<p>The Standard for Skills Development is set at a minimum development support of 0.25% of the project's contract value as per the cidb B.U.I.L.D Programme. (for projects that are R20 million and above and longer than 6 months)</p> <p>The successful tenderer must employ Learners from TVET colleges and universities by providing them with opportunities for workplace learning through placements, thereby acquiring work experience and young professionals seeking candidacy and registration through work placements.</p> <p>The wage rates and the implementation shall be as per the Standard for Developing Skills through Infrastructure Contracts, Published in the Government Gazette No. 43495 of 3 July 2020, issued in terms of sections 5(2) of the Construction Industry Development Board Act, 2000(Act no. 38 of 2000).</p> <p>The penalty for failing to achieve the monetary value of the above target set by the Employer for Skills Development in terms of PART G: Contract Skills Development Goals of section C3.3 Particular Specifications in Part C3: Scope of Work, is 5% of the monetary value by which the achieved monetary value falls short of the target monetary value</p>
<p>5.</p> <p>SCC 5.3.1 and 5.3.2</p>	<p>TIME AND RELATED MATTERS</p> <p>The date of commencement of the Works shall be within 28 days, or 56 days if a construction work permit is required, after the Commencement Date.</p> <p>The following documentation shall be submitted within <u>14 days</u> of the Commencement Date by the Contractor before commencing to carry out the Works:</p> <ul style="list-style-type: none"> (i) Health and Safety Plan (refer to Clause 4.3); (ii) Form C1.4 'Agreement in terms of Section 37(2) of the Occupational Health and Safety Act No. 85 of 1993' to be signed by the Contractor and the Employer (refer to Clause 4.3); (iii) Proof of registration and good standing with the compensation fund or with a licensed compensation insurer as contemplated in the Compensation for Occupational Injuries and Diseases Act, 1993 (Act No. 130 of 1993) (refer to Clause 4.3); (iv) Initial Programme (refer to Clause 5.6); (v) Security (refer to Clause 6.2); and (vi) Insurance (refer to Clause 8.6); (vii) Appointments and proofs of competency [CR 5(1)(h)]. <p>and if the Employer is required to apply for a construction work permit to perform construction work in terms of regulation 3(1) of the Construction Regulations 2014, the following documentation shall also be submitted:</p> <ul style="list-style-type: none"> (i) Temporary works designer's appointment duties in terms of Regulation 6(2) as have been agreed upon plus proof of registration with ECSA [CR 3(5)(b)(iii) read with CR 5(1)(e) and CR 6(2)]; (ii) Evidence that the Principal contractor has made adequate provision for the cost of Health and Safety, i.e., bill of quantities [CR 3(5)(b)(iii) read with CR 5(1)(g)]; and (iii) Evidence that the Principal contractor has the necessary competencies to carry out construction work safely, namely, schedule of activities, relevant appointments and proofs of competency [CR 5(1)(h)].

CLAUSE	CONTRACT SPECIFIC DATA PROVIDED BY THE EMPLOYER
5.8.1	<p>The non-working days are Sundays.</p> <p>The special non-working days are:</p> <ul style="list-style-type: none"> (i) the statutory public holidays in terms of the Public Holidays Act; (ii) the foreseeable election days declared as a statutory public holiday; and (iii) the annual year-end shutdown period as recommended by the Bargaining Council for the Civil Engineering Industry.
5.13.1	<p>The penalty for failing to complete the Works is 0,05% of the Contract Sum per day, up to a maximum limit of twenty-five thousand rand per day (R25 000,00 per day).</p>
5.14.1	<p>The requirements for achieving Practical Completion are as stated in General Conditions of Contract 2015.</p>
SCC 5.14.4	<p>The Contractor shall submit the following:</p> <ul style="list-style-type: none"> (i) evidence that the local labour has been paid, and that the Targeted Enterprise subcontractors have received all amounts due in terms of their respective subcontract agreements; and (ii) the survey and materials information which the Employer's Agent requires to complete the as-built drawings and records.
5.16.3	<p>The latent defects period is Not Applicable.</p>
6.	<p>PAYMENT AND RELATED MATTERS</p> <p>SCC 6.2.1 The security to be provided by the Contractor shall be:</p> <p style="padding-left: 40px;">Fixed Performance Guarantee of 8% of the first One Million Rand plus 3,5% of the balance of the Contract Sum.</p> <p>6.5.1.2.3 The percentage allowance to cover overhead charges is 10%.</p> <p>6.8.2 The value of payment certificates issued shall be adjusted in accordance with the Contract Price Adjustment Schedule with the following data.</p> <p>The values of the coefficients for calculating the Contract Price Adjustment Factor are:</p> <p style="padding-left: 40px;">Routine Maintenance – (Schedules A, E, F and G):</p> <p style="padding-left: 80px;">a = 0,48 b = 0,37 c = 0,05 d = 0,1</p> <p style="padding-left: 40px;">Structures (Schedule B): n/a</p> <p style="padding-left: 80px;">a = 0,15 b = 0,2 c = 0,55 d = 0,1</p> <p>“L”, “P”, “M” and “F” are defined as follows:</p> <p>“L” is the “Labour Index” and shall be the Consumer Price Index for “Geographic Indices > CPI per province > KwaZulu-Natal” as published in Table A of the Statistical Release P0141 of Statistics South Africa.</p> <p>“P” is the “Construction Equipment Index” and shall be the Construction Materials Price Index for “Plant and equipment” as published in Table 4 of the Statistical Release P0151.1 of Statistics South Africa.</p> <p>“M” is the “Materials Index” and shall be the Construction Materials Price Index as published in Table 6 of the Statistical Release P0151.1 of Statistics South Africa for:</p>

CLAUSE	CONTRACT SPECIFIC DATA PROVIDED BY THE EMPLOYER
6.8.3	<p>Routine Maintenance (Schedules A, E, F and G): “Civil engineering material – roads, general (excluding bitumen)”</p> <p>Structures (Schedule B): “Civil engineering material – structures (excluding bitumen)”</p> <p>“F” is the “Fuel Index” and shall be the Producer Price Index for “Coke, petroleum, chemical, rubber and plastic products > Coal and petroleum products > Diesel” as published in Table 1 of the Statistical Release P0142.1 of Statistics South Africa.</p> <p>The base month is the month preceding the month of tender closure.</p> <p>Any index calculated by means of a linking factor between an old and new index, shall be rounded to one decimal place.</p> <p>Price adjustments for variations in the cost of bitumen as a special material are allowed.</p> <p>Only the net bitumen content of asphalt and bituminous products shall be subject to variations in cost, and no account shall be taken of transport, emulsifiers, diluents or modifiers that may be supplied ex refinery or added later.</p> <p>The percentage advance on Plant and materials not yet built into the Permanent Works is 80%.</p> <p>The percentage retention on the amounts due to the Contractor is 10%.</p>
6.10.1.5	<p>The limit of retention money is 5% of the first One Million Rand plus 1,6% of the balance of the Contract Sum excluding contingencies, contract price adjustment, and VAT.</p>
6.10.3	<p>A retention guarantee in lieu of a cash retention is permitted.</p>
8.	<p>RISKS AND RELATED MATTERS</p>
8.6.1.1.2	<p>The value of Plant and materials supplied by the Employer to be included in the insurance sum is <u>nil</u>.</p>
8.6.1.1.3	<p>The amount to cover professional fees for repairing or reinstatement of damage to the Works to be included in the insurance sum is <u>R250 000.00</u>.</p>
8.6.1.2	<p>Special Risks Insurance issued by SASRIA is required.</p>
8.6.1.3	<p>The limit of indemnity for liability insurance is <u>R10 000 000,00 (ten million Rand only)</u> for any single liability claim. Liability insurance shall include spread of fire risk.</p>
10.	<p>CLAIMS AND DISPUTES</p>
10.5.2	<p>Disputes shall be referred to ad-hoc adjudication.</p>
10.5.3	<p>The number of Adjudication Board members to be appointed shall be one.</p>
10.8.1	<p>Unresolved disputes shall be determined by court proceedings.</p>

CLAUSE	CONTRACT SPECIFIC DATA PROVIDED BY THE EMPLOYER
	DATA WITH REFERENCE TO C3.3 PARTICULAR SPECIFICATIONS
PART G G2.9	SMALL CONTRACTOR DEVELOPMENT The target area for local labour is the Umzumbe Municipal Ward/s in which the works occur. The target area for Targeted Enterprises is to be prioritised with preference given to the Umzumbe Municipal Ward , followed by Umzumbe Municipal Area , followed by the Ugu District Area and lastly in the KZN Province .

C1.2.3: DATA PROVIDED BY THE CONTRACTOR

The following contract specific data are applicable to this contract.

CLAUSE	CONTRACT SPECIFIC DATA PROVIDED BY THE CONTRACTOR															
<p>1.</p> <p>1.1.1.9</p> <p>1.2.1.2</p>	<p>GENERAL</p> <p>Name of Contractor:</p> <p>Address of Contractor:</p> <p style="text-align: center;"><u>Physical:</u> <u>Postal:</u></p> <p>.....</p> <p>.....</p> <p>.....</p> <p>.....</p>															
<p>6.</p> <p>6.8.3</p>	<p>PAYMENT AND RELATED MATTERS</p> <p>The tenderer shall complete the table below with respect to each of the special materials listed. This information shall be used to calculate the variation in cost of the special materials.</p> <p>The rates and prices for the special materials for the base month which is the month preceding the month of tender closure, shall exclude VAT but shall include all other obligatory taxes and levies.</p> <p>The tenderer shall append to this page a letter from the supplier confirming the supply price for the net bitumen content of asphalt and bituminous products.</p> <p>A change of supplier due to circumstances beyond the control of the Contractor may be considered, subject to the submission of supporting documentation to the Employer's Agent for valuation to calculate the difference between the rate or price of the special material entered in the table below and the equivalent rate or price actually paid by the Contractor, and for approval.</p> <table border="1" style="width: 100%; border-collapse: collapse;"> <thead> <tr> <th style="text-align: center;">SPECIAL MATERIALS</th> <th style="text-align: center;">UNIT</th> <th style="text-align: center;">RATE OR PRICE FOR THE BASE MONTH</th> </tr> </thead> <tbody> <tr> <td>35/50 penetration grade bitumen</td> <td style="text-align: center;">ton</td> <td>.....</td> </tr> <tr> <td>50/70 penetration grade bitumen</td> <td style="text-align: center;">ton</td> <td>.....</td> </tr> <tr> <td>70/100 penetration grade bitumen</td> <td style="text-align: center;">ton</td> <td>.....</td> </tr> <tr> <td>NIL (if not applicable)</td> <td></td> <td></td> </tr> </tbody> </table> <p>Signed on behalf of the Tenderer:</p>	SPECIAL MATERIALS	UNIT	RATE OR PRICE FOR THE BASE MONTH	35/50 penetration grade bitumen	ton	50/70 penetration grade bitumen	ton	70/100 penetration grade bitumen	ton	NIL (if not applicable)		
SPECIAL MATERIALS	UNIT	RATE OR PRICE FOR THE BASE MONTH														
35/50 penetration grade bitumen	ton														
50/70 penetration grade bitumen	ton														
70/100 penetration grade bitumen	ton														
NIL (if not applicable)																

C1.3: PERFORMANCE GUARANTEE

PRO FORMA

PERFORMANCE GUARANTEE

For use with the General Conditions of Contract for Construction Works, Third Edition (2015).

1. GUARANTOR DETAILS AND DEFINITIONS

“Guarantor” means:

Physical address:

“Employer” means:

“Contractor” means:

“Employer’s Agent” means:

“Works” means:

“Site” means:

“Contract” means: The Agreement made in terms of the Form of Offer and Acceptance and such amendments or additions to the Contract as may be agreed in writing between the parties.

“Contract Sum” means: The accepted amount inclusive of tax of R

Amount in words:

“Guaranteed Sum” means: The maximum aggregate amount of R

Amount in words:

“Expiry Date” means: or any other later date set by the Contractor and/or Employer provided such instruction is received prior to the Expiry Date as indicated here.

2. CONTRACT DETAILS

Employer’s Agent issues: Interim Payment Certificates, Final Payment Certificate and the Certificate of Completion of the Works as defined in the Contract.

3. GUARANTOR’S LIABILITY

3.1 The Guarantor’s liability shall be limited to the amount of the Guaranteed Sum.

3.2 The Guarantor’s period of liability shall be from and including the date on which the Performance Guarantee is signed, up to and including the Expiry Date, or the date of issue by the Employer’s Agent of the Certificate of Completion of the Works, or the date of payment in full of the Guaranteed Sum, whichever occurs first.

3.3 The Employer’s Agent and/or the Employer shall advise the Guarantor in writing of the date on which the Certificate of Completion of the Works has been issued.

4. CONDITIONS APPLICABLE TO THIS PERFORMANCE GUARANTEE

4.1 The Guarantor hereby acknowledges that:

4.1.1 Any reference in this Performance Guarantee to the Contract is made for the purpose of convenience and shall not be construed as any intention whatsoever to create an accessory obligation or any intention whatsoever to create a suretyship.

4.1.2 Its obligation under this Performance Guarantee is restricted to the payment of money.

4.2 Subject to the Guarantor's maximum liability referred to in 3.1, the Guarantor hereby undertakes to pay the Employer the sum certified upon receipt of the documents identified in 4.2.1 to 4.2.3:

4.2.1 A copy of a first written demand issued by the Employer to the Contractor stating that payment of a sum certified by the Employer's Agent in an Interim or Final Payment Certificate has not been made in terms of the Contract and failing such payment within seven (7) calendar days, the Employer intends to call upon the Guarantor to make payment in terms of 4.2.2;

4.2.2 A first written demand issued by the Employer to the Guarantor at the Guarantor's physical address with a copy to the Contractor stating that a period of seven (7) days has elapsed since the first written demand in terms of 4.2.1 and the sum certified has still not been paid;

4.2.3 A copy of the aforesaid payment certificate which entitles the Employer to receive payment in terms of the Contract of the sum certified in 4.2.

4.3 Subject to the Guarantor's maximum liability referred to in 3.1, the Guarantor undertakes to pay to the Employer the Guaranteed Sum or the full outstanding balance upon receipt of a first written demand from the Employer to the Guarantor at the Guarantor's physical address calling up this Performance Guarantee, such demand stating that:

4.3.1 The Contract has been terminated due to the Contractor's default and that this Performance Guarantee is called up in terms of 4.3; or

4.3.2 a provisional or final sequestration or liquidation court order has been granted against the Contractor and that the Performance Guarantee is called up in terms of 4.3; and

4.3.3 The aforesaid written demand is accompanied by a copy of the notice of termination and/or the provisional/final sequestration and/or the provisional liquidation court order.

4.4 It is recorded that the aggregate amount of payments required to be made by the Guarantor in terms of 4.2 and 4.3 shall not exceed the Guarantor's maximum liability in terms of 3.1.

4.5 Where the Guarantor has made payment in terms of 4.3, the Employer shall upon the date of issue of the Final Payment Certificate submit an expense account to the Guarantor showing how all monies received in terms of this Performance Guarantee have been expended and shall refund to the Guarantor any resulting surplus. All monies refunded to the Guarantor in terms of this Performance Guarantee shall bear interest at the prime overdraft rate of the Employer's bank compounded monthly and calculated from the date payment was made by the Guarantor to the Employer until the date of refund.

4.6 Payment by the Guarantor in terms of 4.2 or 4.3 shall be made within seven (7) calendar days upon receipt of the first written demand to the Guarantor.

4.7 Payment by the Guarantor in terms of 4.3 will only be made against the return of the original Performance Guarantee by the Employer.

4.8 The Employer shall have the absolute right to arrange his affairs with the Contractor in any manner which the Employer may consider fit and the Guarantor shall not have the right to claim his release from this Performance Guarantee on account of any conduct alleged to be prejudicial to the Guarantor.

- 4.9 The Guarantor chooses the physical address as stated above for the service of all notices for all purposes in connection herewith.
- 4.10 This Performance Guarantee is neither negotiable nor transferable and shall expire in terms of 3.2, where after no claims will be considered by the Guarantor. The original of this Guarantee shall be returned to the Guarantor after it has expired.
- 4.11 This Performance Guarantee, with the required demand notices in terms of 4.2 or 4.3, shall be regarded as a liquid document for the purposes of obtaining a court order.
- 4.12 Where this Performance Guarantee is issued in the Republic of South Africa the Guarantor hereby consents in terms of Section 45 of the Magistrates' Courts Act No 32 of 1944, as amended, to the jurisdiction of the Magistrate's Court of any district having jurisdiction in terms of Section 28 of the said Act, notwithstanding that the amount of the claim may exceed the jurisdiction of the Magistrate's Court.

Signed at

Date

Guarantor's signatory (1)

Capacity

Guarantor's signatory (2)

Capacity

Witness signatory (1)

Witness signatory (2)

C1.4: AGREEMENT IN TERMS OF SECTION 37(2) OF THE OCCUPATIONAL HEALTH AND SAFETY ACT NO. 85 OF 1993

THIS AGREEMENT is made between The Province of KwaZulu-Natal represented by Head of Department: Department of Transport (hereinafter called the EMPLOYER) of the one part, herein represented by:

.....

in his capacity as:

AND:

(hereinafter called the CONTRACTOR) of the other part, herein represented by:.....

.....

in his capacity as:

duly authorised to sign on behalf of the Contractor.

WHEREAS the CONTRACTOR is the Mandatary of the EMPLOYER in consequence of an agreement between the CONTRACTOR and the EMPLOYER in respect of:

CONTRACT NO. ZNB01307/00000/00/POR/INF/22/T: PROVISION OF MAINTENANCE ON VARIOUS PROVINCIAL ROADS OVER A PERIOD OF 36 MONTHS WITHIN UMZUMBE SOUTHERN ZONE 1 UNDER COST CENTRE PORT SHEPSTONE IN THE DURBAN REGION

for the construction, completion and maintenance of the works;

AND WHEREAS the EMPLOYER and the CONTRACTOR have agreed to enter into an agreement in terms of the provisions of Section 37(2) of the Occupational Health and Safety Act No 85 of 1993, as amended by the Occupational Health and Safety Amendment Act No 181 of 1993 (hereinafter referred to as the ACT);

NOW THEREFORE the parties agree as follows:

1. The CONTRACTOR undertakes to acquaint the appropriate officials and employees of the CONTRACTOR with all relevant provisions of the ACT and the regulations promulgated in terms thereof.
2. The CONTRACTOR undertakes to fully comply with all relevant duties, obligations and prohibitions imposed in terms of the ACT and Regulations: Provided that should the EMPLOYER have prescribed certain arrangements and procedures that same shall be observed and adhered to by the CONTRACTOR, his officials and employees. The CONTRACTOR shall bear the onus of acquainting himself/herself/itself with such arrangements and procedures.
3. The CONTRACTOR hereby accepts sole liability for such due compliance with the relevant duties, obligations, prohibitions, arrangements and procedures, if any, imposed by the ACT and Regulations, and the CONTRACTOR expressly absolves the EMPLOYER and the EMPLOYER'S AGENT from being obliged to comply with any of the aforesaid duties, obligations, prohibitions, arrangements and procedures in respect of the work included in the contract.
4. The CONTRACTOR agrees that any duly authorised officials of the EMPLOYER shall be entitled, although not obliged, to take such steps as may be necessary to ensure that the CONTRACTOR has complied with his undertakings as more fully set out in paragraphs 1 and 2 above, which steps may include, but shall not be limited to, the right to inspect any appropriate site or premises occupied by the CONTRACTOR, or to take such steps the EMPLOYER may deem necessary to remedy the default of the CONTRACTOR at the cost of the CONTRACTOR.

5. The CONTRACTOR shall be obliged to report forthwith to the EMPLOYER any investigation, complaint or criminal charge which may arise as a consequence of the provisions of the ACT and Regulations, pursuant to work performed in terms of this agreement, and shall, on written demand, provide full details in writing of such investigation, complaint or criminal charge.

Thus signed at for and on behalf of the **EMPLOYER**

on this the day of 20.....

SIGNATURE:

NAME AND SURNAME:

CAPACITY:

WITNESSES: 1.

2.

Thus signed at for and on behalf of the **CONTRACTOR**

on this the day of 20.....

SIGNATURE:

NAME AND SURNAME:

CAPACITY:

WITNESSES: 1.

2.

C1.5: RETENTION MONEY GUARANTEE

PRO FORMA

RETENTION MONEY GUARANTEE

THE HEAD: TRANSPORT
PROVINCE OF KWAZULU-NATAL
PRIVATE BAG X9043
PIETERMARITZBURG
3200

CONTRACT NO. _____ FOR _____

ISSUED TO: the **PROVINCE OF KWAZULU-NATAL**, represented by **HEAD: TRANSPORT** (hereinafter referred to as "the Employer")

ON BEHALF OF: (hereinafter referred to as "the Contractor")

In connection with

CONTRACT NO. ZNB01307/00000/00/POR/INF/22/T
(hereinafter referred to as "the Contract")

WHEREAS the Employer and the Contractor have agreed that the Contractor may provide a guarantee in lieu of the whole or portion of the retention monies provided for under the Contract;

NOW THEREFORE we, the undersigned, undertake, in accordance with the following provisions, to pay the Employer such amounts as the Employer may, from time to time, demand from us.

1. Each demand by the Employer shall be in writing signed by the Employer and delivered to us at

.....
or such other address as we shall in writing notify to the Employer and shall be accompanied by a certificate complying with Clause 2, signed by the Employer's Agent as such in terms of the Contract.

2. The Employer's Agent's certificate referred to in Clause 1 shall certify

- (a) that he is the Employer's Agent in terms of the Contract,
- (b) that the Contractor is in breach of his obligations under the Contract, and
- (c) that the amount demanded, which amount the certificate shall specify,

- (i) does not exceed the amount of retention monies which, but for this guarantee, would have been retained by the Employer in terms of the Contract at the date of the certificate, less the aggregate of the amounts of retention money actually retained by the Employer and the amounts previously paid by us to the Employer in terms hereof, and

- (ii) does not exceed a genuine estimate of the cost to the Employer of having the breach referred to in paragraph (b) remedied less the aggregate of any amounts withheld by the Employer from payments due the Contractor in terms of the Contract by reason of the breach referred to, and any amount in retention money actually held by the Employer save to the extent that the same had been deducted from any previous demand in terms hereof.

3. We shall within 28 days after our receipt of a demand complying with the provisions of Clauses 1 and 2 make payment to the Employer of the amount demanded at 172 Burger Street, Pietermaritzburg or at such other address as the Employer shall in writing notify us.

4. Subject to compliance with the provisions thereof, our liability to make the payments herein referred to shall be unconditional and shall not be affected nor diminished by any disputes, claims or counterclaims

between the Employer and the Contractor.

5. Our aggregate liability under this guarantee is limited to R
6. This guarantee shall expire on the date on which the last of the retention monies, which but for this guarantee would have been retained by the Employer, becomes payable to the Contractor.
7. This guarantee is not transferable and must be produced for endorsement if any part payment is made and must be returned to us against final payment of our aggregate liability or on the date of the expiry of the guarantee in terms of Clause 6, whichever is the earlier.

Signed in the presence of the witnesses named hereunder:

At for and on behalf of

on this day of

Signature:

Capacity:

Address:

As Witnesses:

1. Name in Block Letters

2. Name in Block Letters

C1.6: TRANSFER OF RIGHTS

TRANSFER OF RIGHTS AND INDEMNITY

(To be completed during construction by successful Tenderer only)

Claim for Plant and materials on site, Payment Certificate No. Date:

Contract No: For (contract title)

I, the undersigned (name of signatory) in my capacity as
..... of (name of Contractor)

duly authorised hereto on behalf of the Contractor hereby transfer, cede and assign all the Contractor's rights, title and interest in and to the Plant and materials, for which evidence of bona fide ownership is attached hereto, unto and in favour of (name of Employer)

Insofar as the Contractor retains actual control of the materials and goods, the right of ownership thereof passes to the Employer by *constitutum possessorium*.

I herewith indemnify the Employer against any claim to and in respect of the said Plant and materials by reason of the Contractor's sequestration or liquidation or of any defect in the Contractor's title to the materials and agree that no payment for materials on site will be made by the Employer until such time as I have submitted documentary proof of bona fide ownership of the said Plant and materials.

This transfer shall become effective upon conclusion of the Contractor receiving payment from the Employer or from any other person on behalf of the Employer for the Plant and materials as Plant and materials on Site, payment of retention money thereon excluded.

I further confirm that I am fully responsible for all Plant and materials listed under this Transfer of Rights and that they have been insured adequately against all risks and will remain insured until they are built into or used in the permanent works and taken over by the Employer.

This certificate of Transfer of Rights applies only to the Plant and materials as listed in the following table.

DESCRIPTION OF ITEM	UNIT	QUANTITY	RATE	AMOUNT	SUPPLIER
TOTAL VALUE OF PLANT AND MATERIALS					

Signed by: Date:
for and on behalf of the Contractor.

Witnessed by:

NOTE: This form, together with the documentary proof of ownership or proof of payment by the Contractor to the supplier, shall accompany the Contractor's claim for payment for Plant and materials on site in terms of Clause 6.10.1.5 of the General Conditions of Contract 2015.

PART C2: PRICING DATA

C2.1 PRICING ASSUMPTIONS

1. GENERAL

The Bill of Quantities forms part of the Contract Documents and must be read and priced in conjunction with all the other documents comprising the Contract Documents, which include the Conditions of Tender, Conditions of Contract, the Specifications (including the Project Specifications) and the Drawings.

The contractor shall determine the contract skills participation goals, expressed in Rand, which shall not be less than the SUB-TOTAL 1 multiplied by a percentage factor given in Table 2 in the Standard for the applicable class of construction works. For this contract, the percentage shall be 0.25%. This is indicated by the percentage factor in the Final Tender Summary section. Minimum Contract Skills Development Goal (CSDG) sum = Civil Engineering CE (0.25%) x SUB – TOTAL 1 of the tender amount.

2. DESCRIPTION OF ITEMS IN THE SCHEDULE

The Bill of Quantities has been drawn up generally in accordance with the relevant provisions of the Standard Specifications for Road and Bridge Works for South African Road Authorities (COTO), Draft Standard (DS), October 2020.

The short descriptions of the items in the Bill of Quantities are for identification purposes only and the measurement and payment clause of the Standard Specifications for Road and Bridge Works for South African Road Authorities (COTO), Draft Standard (DS), October 2020. and the Particular Specifications, read together with the relevant clauses of the amendments and additions contained in the Project Specifications and directives on the drawings, set out what ancillary or associated work and activities are included in the rates for the operations specified.

The item numbers appearing in the Bill of Quantities refer to the corresponding item numbers in the Standard Specifications for Road and Bridge Works for South African Road Authorities (COTO), Draft Standard (DS), October 2020. Item numbers prefixed by the letter PS refer to items of payment described in Part B Amendments to the Standard Specifications.

For the purposes of this Bill of Quantities, the following words shall have the meanings hereby assigned to them:

Unit: The unit of measurement for each item of work as defined in the specifications.

Quantity: The number of units of work for each item.

Rate: The payment per unit of measurement at which the Tenderer tenders to do the work.

Amount: The product of the quantity and the rate tendered for an item.

Lump Sum: An amount tendered for an item, the extent of which is described in the Bill of Quantities, the specifications or elsewhere, but the quantity of work of which is not measured in any units.

3. QUANTITIES REFLECTED IN THE BILL OF QUANTITIES

The quantities given in the Bill of Quantities are estimates only, and are subject to re-measure during the execution of the work. The quantities finally accepted and certified for payment, and not the quantities given in the Bill of Quantities, shall be used to determine payments to the Contractor. The Contractor shall obtain the Employer's Agent's detailed instructions for all work before ordering any materials or executing work or making arrangements for it. The quantities of material or work stated in the Bill of Quantities shall not be regarded as authorisation for the Contractor to order material or to

execute work.

The Works as finally completed in accordance with the Contract shall be measured and paid for as specified in the Bill of Quantities and in accordance with the Standard Specifications for Road and Bridge Works for South African Road Authorities (COTO), Draft Standard (DS), October 2020, the Project Specifications and the Drawings. Unless otherwise stated, items are measured net in accordance with the Drawings, and no allowance has been made for waste. The validity of the contract will in no way be affected by differences between the quantities in the Bill of Quantities and the quantities finally certified for payment.

4. PROVISIONAL SUMS

Where Provisional sums or Prime Cost sums are provided for items in the Bill of Quantities, payment for the work done under such items will be made in accordance with Clause 6.6 of the General Conditions of Contract 2015. The Employer reserves the right, during the execution of the works, to adjust the stated amounts upwards or downwards according to the work actually done under the item, or the item may be omitted altogether, without affecting the validity of the Contract.

The Tenderer shall not under any circumstances whatsoever delete or amend any of the sums inserted by the Employer in the "Amount" column of the Bill of Quantities and in the Summary of the Bill of Quantities unless so ordered or authorised in writing by the Employer before closure of tenders. Any unauthorised changes made by the Tenderer to provisional items in the Bill of Quantities, or to the provisional percentages and sums in the Summary of the Bill of Quantities, at the Employer's discretion, may invalidate the Tenderer's offer or may be treated as arithmetical errors and the provisional items and percentages corrected without change to the Contract Sum.

5. PRICING OF THE BILL OF QUANTITIES

The prices and rates to be inserted by the Tenderer in the Bill of Quantities shall be the full inclusive prices to be paid by the Employer for the work described under the several items, and shall include full compensation for all costs and expenses that may be required in and for the completion and maintenance during the defects liability period of all the work described and as shown on the drawings as well as all overheads, profits, incidentals and the cost of all general risks, liabilities and obligations set forth or implied in the documents on which the Tender is based. The rates and lump sums shall be comprehensive in accordance with Standard Specifications for Road and Bridge Works for South African Road Authorities (COTO), Draft Standard (DS), October 2020.

Each item shall be priced and extended to the "Amount" column by the Tenderer, with the exception of the items for which only rates are required, or items which already have Prime Cost or Provisional Sums affixed thereto. If the Tenderer omits to price any items in the Bill of Quantities, then these items will be considered to have a nil rate or price.

All items for which terminology such as "inclusive" or "not applicable" have been added by the Tenderer will be regarded as having a nil rate which shall be valid irrespective of any change in quantities during the execution of the Contract.

Should the Tenderer group a number of items together and tender one lump sum for such group of items, this single lump sum shall apply to that group of items and not to each individual item.

The tendered lump sums and rates shall be valid irrespective of any change in the quantities during the execution of the contract.

The Tenderer shall fill in rates for all items where the words "rate only" appear in the "Amount" column. The provisions of sub clause C1.1.3.6 of the Standard Specifications for Road and Bridge Works for South African Road Authorities (COTO), Draft Standard (DS), October 2020 shall apply to rate only items. "Rate Only" items have been included where:

- (a) an alternative item or material is contemplated;
- (b) variations of specified components in the make-up of a pay item may be expected; and
- (c) no work under the item is foreseen at tender stage but the possibility that such work may be

required is not excluded.

For "Rate Only" items, no quantities are given in the "Quantity" column but the quoted rate shall apply in the event of work under this item being required. The Tenderer shall, however, note that in terms of the Tender Data the Tenderer may be asked to reconsider any such rates which the Employer may regard as imbalanced.

Reasonable compensation will be received where no pay item appears in respect of work required in terms of the Contract which is not covered in any other pay item.

All rates and amounts quoted in the Bill of Quantities shall be in Rands and cents and shall include all levies and taxes (other than VAT). VAT will be added in the summary of the Bill of Quantities. Note that fractions of a cent in all rates shall be omitted.

6. CORRECTION OF ENTRIES

Incorrect entries shall not be erased or obliterated with correction fluid but must be crossed out neatly. The correct figures must be entered above or adjacent to the deleted entry, and the alteration must be initialled by the Tenderer.

7. INTERIM PAYMENTS

Unless otherwise specified, progress payments in Interim Certificates, referred to in Clause 6.10 of the General Conditions of Contract 2015, in respect of "sum" items in the Bill of Quantities shall be by means of interim progress instalments assessed by the Employer's Agent and based on the measure in which the work actually carried out relates to the extent of the work to be executed by the Contractor.

Notwithstanding any custom to the contrary, the work as executed will be measured for payment in accordance with the methods described in the contract documents under the various items of payment.

Attention is directed to the provisions of Clause C1.1.2 of the Standard Specifications for Road and Bridge Works for South African Road Authorities (COTO), Draft Standard (DS), October 2020 regarding the measurement of quantities for payment. Except where specified otherwise, the nett measurements or mass of the finished work in place shall be taken for payment, but any quantity of work in excess of that prescribed shall be excluded.

8. ITEMS SCHEDULED FOR CONSTRUCTION USING LABOUR ENHANCED METHODS

Those parts of the Works to be constructed using labour enhanced methods are numbered with the specific COTO, Draft Standard (DS), October 2020 Specifications items in the Bill of Quantities.

9. UNITS OF MEASUREMENT

The units of measurement described in the Bill of Quantities are metric units. The following abbreviations are used in the Bill of Quantities:

mm	= millimetre	m ³ .km	= cubic metre kilometre	Prov sum	= provisional sum
m	= metre	l	= litre	kPa	= kilopascal
km	= kilometre	kl	= kilolitre	MPa	= megapascal
km.pass	= kilometre pass	kg	= kilogram	MN	= meganewton
m ²	= square metre	t	= ton (1 000 kg)	t.km	= ton kilometre
m ² .pass	= square metre pass	No	= number	h	= hour
ha	= hectare	%	= percent	dia	= diameter
m ³	= cubic metre	PC sum	= prime cost sum	Sum	= lump sum
kW	= kilowatt	MN.m	= meganewton metre		

10. CONSISTENCY OF RATES

In order to ensure that payments certified by the Employer's Agent are reasonably consistent with the market value of the work done, and that variations in quantities do not distort the contract valuation, the rates, prices and amounts tendered in the Bill of Quantities are required to be in balance.

A tender will be considered out of balance if:

- (i) the combined, extended total tendered for the item:

PSC1.3.1 The contractor's general obligations:

- C1.3.1.1 Fixed obligations
- C1.3.1.2 Value-related obligations
- PSC1.3.1.3 Time-related obligations

exceeds a maximum of 15% of the Contract Sum (excluding contingencies, contract price adjustment and VAT).

- (ii) the rate, price or amount tendered for any other item differs by more than 20 (twenty) percent from the average of the rates, prices or amounts for the same item as tendered by those tenderers who submitted the lowest five responsive tender offers (or as tendered by all the responsive tenderers if there are less than five responsive tenderers).

Any such out of balance tender may be rejected if, after three (3) working days of having been given written notice by the Employer to adjust those rates or lump sums which are unreasonable or out of balance, the Tenderer fails to make the necessary satisfactory adjustments. These adjustments in rectification will be such that increases are balanced by decreases, leaving the tender offer unchanged.

The amount payable to the contractor for time-related general obligations arising from extensions of time granted in accordance with Clause 5.12.1 and Clause 5.12.2 of the GCC 2015, shall be calculated as follows:

- (i) The Contractor shall apply for the extension of time in terms of the number of days delay incurred calculated in accordance with Clause 5.1 of the GCC 2015.
- (ii) The number of days extension of time calculated in accordance with Clause 5.1 of the GCC 2015, finally granted shall then be added to the due completion date of the contract by the Engineer, commencing on the first working day after the day of the original due completion date. Non-working days and **special non-working** days as defined in the contract data shall not be counted

as working days in calculating the extended completion date. (iii) The number of calendar days extension of time granted from the original completion date to the extended completion date as calculated in (ii) above shall then be calculated, commencing on the first calendar day after the day of the original completion date.

The following formula shall then be used to calculate the number of months extension of time granted;

No. of months extension of time granted
= [(No. of calendar days extension of time granted / 365)] × 12

(iii) The number of months extension of time granted calculated as in (iii) above shall be the number of additional months measured for payment for time-related general obligations under item PSC1.3.1.3 and in accordance with Clause 5.12.3 of the GCC 2015 as a result of the extensions of time granted.

NOTE: The number of months extension of time granted calculated as in (iii) above shall also be included in the measurement of any other items scheduled under Sections C1.3, C1.4 and C1.5 or elsewhere in the schedule of quantities that involve the unit of measurement "month" and that were provided on site for the full duration of the extended period. Where such items were provided for a portion of the extended period only, a pro rata payment shall be made, based on the number of calendar days the item was provided on site after the original completion date divided by the number of calendar days as calculated in (iii) above for the extension of time granted

C2.2 BILL OF QUANTITIES

<u>TABLE OF CONTENTS</u>	Page
BILL OF QUANTITIES	C31
TENDER SUMMARY.....	C55

CONTRACT NO. ZNB01307/00000/00/POR/INF/22/T: PROVISION OF MAINTENANCE ON VARIOUS PROVINCIAL ROADS OVER A PERIOD OF 36 MONTHS WITHIN UMZUMBE SOUTHERN ZONE 1 UNDER COST CENTRE PORT SHEPSTONE IN THE DURBAN REGION

C1.2	GENERAL REQUIREMENTS AND PROVISIONS				
ITEM	DESCRIPTION	UNIT	QTY	RATE	AMOUNT R
C1.2.1	Environmental Management				
C1.2.1.1	Monitoring of compliance with and reporting on the EMP	month	36		
C1.2.1.2	Dedicated environmental officer (if specified in the Contract Documentation)	month	36		
C1.2.2	Programming and Reporting				
C1.2.2.1	Submission of a Scheme 1 Programme	lump sum	1		
C1.2.2.3	Submission of a Scheme 2 Initial Programme	lump sum	1		
C1.2.2.4	Submission of a Scheme 2 Full Programme	lump sum	1		
C1.2.2.5	Reviewing and updating a Scheme 2 programme every month	month	36		
C1.2.3	Routine road maintenance of existing public roads within the Site of the Works or other public roads outside the Site of the Works which are used as detours				
C 1.2.3.1	Grass cutting	ha	10		
AMOUNT CARRIED FORWARD					

C1.2		GENERAL REQUIREMENTS AND PROVISIONS			
ITEM	DESCRIPTION	UNIT	QTY	RATE	AMOUNT R
AMOUNT BROUGHT FORWARD					
PSC1.2.5	Safety				
PSC1.2.5.1	Health and safety plan	lump sum	1		
PSC1.2.5.2	Implementation of health and safety plan				
	(a) Fixed obligations	lump sum	1		
	(b) Time related obligations	month	36		
C1.2.8	Dayworks				
C1.2.8.1	Personnel				
	(a) Unskilled labourer	hr	279		
AMOUNT CARRIED FORWARD					

C1.2 GENERAL REQUIREMENTS AND PROVISIONS					
ITEM	DESCRIPTION	UNIT	QTY	RATE	AMOUNT R
AMOUNT BROUGHT FORWARD					
C1.2.8.2	(c) Skilled labourer	hr	138		
	(e) Foreman	hr	77		
	Construction equipment				
	(a) Motor grader, self propelled, mass not less than 9 tons, power approximately 100 Kw	hr	35		
	(b) Vibratory roller, 9-12 ton mass	hr	29		
	(e) Tractor loader backhoe, 55-70 kW, 0.5m ³ bucket	hr	29		
	(f) Excavator, minimum power 105 kW	hr	31		
	(h) Other equipment				
	(i) Bulldozer (Min 104 kW or similar)	hr	6		
	(ii) Tip trucks (Min. 10.0m ³ capacity)	hr	81		
C1.2.8.3	(iii) Water cart (Min. 10 000 litre)	hr	52		
	Vehicles				
	(b) Flatbed truck, 10-ton minimum load capacity	km	281		
C1.2.8.4	(c) Dump truck	km	55		
	Materials				
C1.2.8.4	(a) Procurement of materials	Prov.Sum	1	R90 000.00	R 90 000.00
	(b) Contractor's handling costs, profit and all other charges in respect of item C1.2.8.4(a)	%	90 000		
PSC.1.2.3.10	Stakeholder liaison				
	(a) Project Liaison Committee	Prov.Sum	1	R450 000.00	R 450 000.00
AMOUNT CARRIED FORWARD					

C1.2	GENERAL REQUIREMENTS AND PROVISIONS				
ITEM	DESCRIPTION	UNIT	QTY	RATE	AMOUNT R
AMOUNT BROUGHT FORWARD					
	(b)Handling cost and profit in respect of subitem PSA 1.2.3.10 (a)	%	450 000		
	(c) Project Liaison Officer	Prov.Sum	1	R 450 000.00	R 450 000.00
	(d)Handling cost and profit in respect of subitem PSA 1.2.3.10 (c)	%	450 000		
PSC.1.2.3.11	Compensation for Surveyor				
	(a) Provision of Survey as requested by the Engineer	Prov.Sum	1	R 100 000.00	R 100 000.00
	(b) Handling cost and profit in respect of subitem PSC 1.2.3.11(a)	%	100 000		
PSC.1.2.3.12	Compensation for Geotechnical Consultant				
	(a) Provision of Geotechnical Engineering Specialist as requested by the Engineer	Prov.Sum	1	R 100 000.00	R 100 000.00
	(b) Handling cost and profit in respect of subitem PSC 1.2.3.12 (a)	%	100 000		
PSC.1.2.3.13	Compensation for Environmental Consultant				
	(a) Provision of Environmental Consultant as requested by the Engineer	Prov.Sum	1	R 100 000.00	R 100 000.00
	(b) Handling cost and profit in respect of subitem PSC 1.2.3.13(a)	%	100 000		
PSC.1.2.3.14	Compensation for Health and Safety Agent				
	(a) Provision of a Health and Safety Agent as requested by the Engineer	Prov.Sum	1	R 500 000.00	R 500 000.00
	(b) Handling cost and profit in respect of subitem PSC 1.2.3.14(a)	%	500 000		
PSC.1.2.3.15	Adhoc Designs as conducted by the Engineer				
AMOUNT CARRIED FORWARD					

C1.2	GENERAL REQUIREMENTS AND PROVISIONS				
ITEM	DESCRIPTION	UNIT	QTY	RATE	AMOUNT R
AMOUNT BROUGHT FORWARD					
	(a) Provision of a Adhoc designs as conducted by Registered Professional (Pr Eng or PR Tech Eng)	Prov.Sum	1	R 200 000.00	R 200 000.00
	(b) Handling cost and profit in respect of subitem PSC 1.2.3.15(a)	%	200 000		
TOTAL CARRIED FORWARD TO SUMMARY					

C1.3	CONTRACTOR'S ESTABLISHMENT ON SITE AND GENERAL ON SITE AND GENERAL OBLIGATIONS				
ITEM	DESCRIPTION	UNIT	QTY	RATE	AMOUNT R
C1.3.1	The Contractor's general obligations				
C1.3.1.1	Fixed obligations	lump sum	1		
C1.3.1.2	Value-related obligations	lump sum	1		
C1.3.1.3	Time-related obligations	month	36		
C1.3.2	Contract sign boards	m ²	200		
TOTAL CARRIED FORWARD TO SUMMARY					

C1.7	LOADING AND HAULING				
ITEM	DESCRIPTION	UNIT	QTY	RATE	AMOUNT R
C1.7.2.2	Hauling material to spoil and off-loading it at a designated spoil or stockpile area:				
	(b)(i) Soil and gravel material	m ³ - km	47 917		
	(c) Boulders, hard material and concrete	m ³ - km	12 305		
TOTAL CARRIED FORWARD TO SUMMARY					

C4.3	EXISTING ROAD MATERIALS				
ITEM	DESCRIPTION	UNIT	QTY	RATE	AMOUNT R
C4.3.18	Excavate non-compliant or excess pavement layer material to spoil in sites designated by the Contractor, material consisting of				
C4.3.18.2	Crushed stone, macadam, gravel and sand material	m ³	1 100		
TOTAL CARRIED FORWARD TO SUMMARY					

C4.4	COMMERCIAL MATERIALS				
ITEM	DESCRIPTION	UNIT	QTY	RATE	AMOUNT R
C4.4.2	Commercial materials identified by the Contractor from commercial, private or other non-commercial suppliers (source of material must be licenced)				
	(g) Type G5B materials	m ³	1 100		
	(j) Type G7 materials	m ³	24		
	(q) Natural or crushed gravel material for the wearing course of an unsealed road	m ³	16 000		
C4.4.4	Cementitious stabilising agents				
	(a) Cement CEM II or III	t	93		
TOTAL CARRIED FORWARD TO SUMMARY					

C5.1	ROADBED				
ITEM	DESCRIPTION	UNIT	QTY	RATE	AMOUNT R
C5.1.1	Roadbed construction and compaction:				
C5.1.1.2	Compaction of in-situ material to 93% of MDD	m ³	19 494		
TOTAL CARRIED FORWARD TO SUMMARY					

C5.2	FILL				
ITEM	DESCRIPTION	UNIT	QTY	RATE	AMOUNT R
C5.2.2	Fill construction:				
C5.2.2.1	Normal fill material in compacted layer thicknesses of 200mm and less: (b) Compacted to 93% of MDD	m ³	22		
TOTAL CARRIED FORWARD TO SUMMARY					

C5.3	ROAD PAVEMENT LAYERS				
ITEM	DESCRIPTION	UNIT	QTY	RATE	AMOUNT R
C5.3.2	Construction of pavement layers				
C5.3.2.1	Construction of layers using conventional construction methods:				
	(g) Gravel wearing course layer (150 mm) compacted to 95 % of MDD	m ³	16 000		
TOTAL CARRIED FORWARD TO SUMMARY					

C5.4		STABILISATION			
ITEM	DESCRIPTION	UNIT	QTY	RATE	AMOUNT R
C5.4.2	Chemical stabilisation: (a) Chemical stabilisation (150mm thick) of pavement layers (C4 base layer)	m ³	1 000		
C5.4.5	Cementitious stabilisation agents for pavement layers:				
C5.4.5.2	Addition of cementitious stabilisation agents (CEM III 32,5N) for pavement layers and spreading the agent using bags and labour enhancement methods. (a) Cement (Cem CEM III 32,5N)	t	50		
C5.4.10	Provision and application of water for curing	kℓ	100		
TOTAL CARRIED FORWARD TO SUMMARY					

C6.1 PAVER LAID CONCRETE LAYERS					
ITEM	DESCRIPTION	UNIT	QTY	RATE	AMOUNT R
C6.1.1	Construction of trial section (Complete: including texturing and curing)				
C6.1.1.2	Labour enhanced construction (160mm 35/20)	m ²	100		
C6.1.2	Construction of jointed concrete pavement (JCP) (Excluding texturing and curing)				
	(b) Labour enhanced construction (160 mm)	m ²	6 000		
C6.1.2.3	Additional concrete placed to thicken up the slab at joints as specified in the Contract Documentation	m ³	80		
C6.1.4	Texturing and curing the concrete pavement				
C6.1.4.2	Burlap-dragged and broom finish only	m ²	6 000		
C6.1.4.3	Curing: (b) Labour enhanced construction	m ²	6 000		
C6.1.5	Variation in the rate of application of the curing compound	ℓ	300		
C6.1.6	Joints				
C6.1.6.2	Longitudinal hinge joints:				
C6.1.6.3	Sealed transverse contraction joints sawn in two separate operations (widths as shown on the drawings - refer Concrete Pavement Detail)	m	440		
C6.1.6.4	Dowel bars: mild steel inserted in new concrete (indicate diameter, length and position on drawings): Pre-installed on approved frame	No	1 400		
AMOUNT CARRIED FORWARD					

C6.1 PAVER LAID CONCRETE LAYERS					
ITEM	DESCRIPTION	UNIT	QTY	RATE	AMOUNT R
AMOUNT BROUGHT FORWARD					
C6.1.6.5	Tie-bars: installed in new concrete (b) High tensile steel (12 mm dia, and 650 mm long and 750 c/c shape code 37 tie-bar)	No	1 400		
C6.1.7	Steel reinforcement in concrete pavements				
C6.1.7.3	Welded steel fabric	kg	15 000		
C6.1.8	Drilling of testing of cores				
C6.1.8.1	100mm cores drilled from pavement for testing of compressive strength	No	10		
TOTAL CARRIED FORWARD TO SUMMARY					

C11.9	FINISHING THE ROAD RESERVE AND TREATING OLD ROADS				
ITEM	DESCRIPTION	UNIT	QTY	RATE	AMOUNT R
C11.9.1	Finishing the road and road reserve:				
C11.9.1.2	Single carriageway road	km	32		
C11.9.2	Treatment of old roads and temporary deviations				
TOTAL CARRIED FORWARD TO SUMMARY					

C20.1	TESTING MATERIALS AND JUDGEMENT OF WORKMANSHIP				
ITEM	DESCRIPTION	UNIT	QTY	RATE	AMOUNT R
C20.1.1	Special tests on elastomeric bearings (150% vertical load and 150% shear distortion)				
C20.1.2	Special tests requested by the Engineer				
	(a) Compaction test	prime cost sum	1	R 50 000.00	R 50 000.00
	(i) Handling costs and profit in respect of item C20.1.2.2(a)	%	50 000		
TOTAL CARRIED FORWARD TO SUMMARY					

SCHEDULE A: ROADWORKS

SUMMARY OF PRICING SCHEDULE			
CONTRACT No. ZNB01307/00000/00/POR/INF/22/T			
1. GENERAL			
C1.2	GENERAL REQUIREMENTS AND PROVISIONS		
C1.3	CONTRACTOR'S SITE ESTABLISHMENT AND GENERAL OBLIGATIONS		
C1.7	LOADING AND HAULING		
4. EARTHWORKS AND PAVEMENT LAYERS MATERIALS			
C4.3	EXISTING ROAD MATERIALS		
C4.4	COMMERCIAL MATERIALS		
5. EARTHWORKS AND PAVEMENT LAYERS CONSTRUCTION			
C5.1	ROADBED		
C5.2	FILL		
C5.3	ROAD PAVEMENT LAYERS		
C5.4	STABILISATION		
6. CONCRETE LAYERS			
C6.1	PAVER LAID CONCRETE LAYERS		
11. ANCILLARY ROAD WORKS			
C11.9	FINISHING THE ROAD AND ROAD RESERVE AND TREATING OLD ROADS		
20. QUALITY ASSURANCE			
C20.1	TESTING MATERIALS AND JUDGEMENT OF WORKMANSHIP		
	SUBTOTAL SCHEDULE A		

SCHEDULE E: EXPANDED PUBLIC WORKS PROGRAMME

ITEM	DESCRIPTION	UNIT	QTY	RATE	AMOUNT R
E	EXPANDED PUBLIC WORKS PROGRAMME				
E6.01	Provision of the training venue facility, including the cost of transporting the learners to and from this facility:	Sum	1		
E6.02	Training of learners employed by the contractor or Targeted Enterprise subcontractors:				
	(a) Generic skills:				
	(i) Training costs	Prov sum	1	R 300 000.00	R300 000.00
	(ii) Handling costs and profit in respect of subitem E6.02(a)(i)	%	R300 000		
	(b) Entrepreneurial skills:				
	(i) Training costs	Prov sum	1	R400 000.00	R400 000.00
	(ii) Handling costs and profit in respect of subitem E6.02(b)(i)	%	R400 000		
	(c) Construction skills:				
	(i) Training costs	Prov sum	1	R462 908.58	R462 908.58
	(ii) Handling costs and profit in respect of subitem E6.02(c)(i)	%	R462 908.58		
	(d) Transportation and accommodation costs of selected learners only, while receiving off-site training:				
	(i) Transportation and accommodation costs	Prov sum	1	R250 000.00	R250 000.00
	(ii) Handling costs and profit in respect of subitem E6.02(d)(i)	%	R250 000		
AMOUNT CARRIED FORWARD					

SCHEDULE E: EXPANDED PUBLIC WORKS PROGRAMME

ITEM	DESCRIPTION	LI	UNIT	QTY	RATE	AMOUNT R
AMOUNT BROUGHT FORWARD						
E6.03	Payments associated with the NYS programme:					
	(a) Employment of NYS workers		Prov sum	1	R440 000.00	R440 000.00
	(b) Provision of tools and apparel for NYS workers		Prov sum	1	R30 000.00	R30 000.00
	(c) Handling costs and profit in respect of subitems E6.03(a) and (b)		%	R470 000		
	(d) Training of NYS workers:					
	(i) Provision of training for NYS workers		Prov sum	1	R100 000.00	R100 000.00
	(ii) Handling costs and profit in respect of subitem E6.03(d)(i)		%	R100 000		
	(e) Liaison with the Employer's project manager and the training service provider:					
	(i) Liaison conducted by the Construction Manager		h	150		
	(ii) Liaison conducted by the senior site foreman		h	300		
TOTAL CARRIED FORWARD TO SUMMARY						

SCHEDULE F: SMALL CONTRACTOR DEVELOPMENT

ITEM	DESCRIPTION	LI	UNIT	QTY	RATE	AMOUNT R
F	SMALL CONTRACTOR DEVELOPMENT					
F10.01	Procurement of Targeted Enterprises: (a) Management and execution of Targeted Enterprise procurement process: (i) Procurement process for the appointment of CIDB contractor grading designation 1 Targeted Enterprise subcontractor (100 copies of the tender document required for each individual tender) (ii) Procurement process for the appointment of CIDB contractor grading designation 2 Targeted Enterprise subcontractor (80 copies of the tender document required for each individual tender) (iii) Procurement process for the appointment of CIDB contractor grading designation 3 Targeted Enterprise subcontractor (60 copies of the tender document required for each individual tender)		No	12		
			No	6		
			No	2		
AMOUNT CARRIED FORWARD						

SCHEDULE F: SMALL CONTRACTOR DEVELOPMENT

ITEM	DESCRIPTION	UNIT	QTY	RATE	AMOUNT R
AMOUNT BROUGHT FORWARD					
F10.02	Construction Works for Targeted Enterprise subcontractors:				
	(a) Payments associated with the construction Works carried out by Targeted Enterprise subcontractors	Prov sum	1	R9 136 151.20	R9 136 151.20
	(b) Handling costs and profit in respect of subitem F10.02(a)	%	R9 136 151.20		
	(c) Supply of materials and small construction equipment to assist Targeted Enterprise subcontractors	Prov sum	1	R2 284 037.80	R2 284 037.80
	(d) Handling costs and profit in respect of subitem F10.02(c)	%	R2 284 037.80		
	(e) Management of Targeted Enterprise subcontractors	Sum	1		
F10.03	Training of learners employed by Targeted Enterprise subcontractors:				
	(a) Generic skills:				
	(i) Training costs	Prov sum	1	R90 908.77	R90 908.77
	(ii) Handling costs and profit in respect of subitem F10.03(a)(i)	%	R90 908.77		
	(b) Entrepreneurial skills:				
	(i) Training costs	Prov sum	1	R250 000.00	R250 000.00
	(ii) Handling costs and profit in respect of subitem F10.03(b)(i)	%	R250 000		
	(c) Construction skills:				
	(i) Training costs	Prov sum	1	R300 000.00	R300 000.00
	(ii) Handling costs and profit in respect of subitem F10.03(c)(i)	%	R300 000		
AMOUNT CARRIED FORWARD					

ITEM	DESCRIPTION	UNIT	QTY	RATE	AMOUNT R
AMOUNT BROUGHT FORWARD					
	(d) Transportation and accommodation costs of selected learners only, while receiving off-site training:				
	(i) Transportation and accommodation costs	Prov sum	1	R125 000.00	R125 000.00
	(ii) Handling costs and profit in respect of subitem F10.03(d)(i)	%	R125 000		
TOTAL CARRIED FORWARD TO SUMMARY					

PROVINCE OF KWAZULU-NATAL
DEPARTMENT OF TRANSPORT

CONTRACT NO. ZNB01307/00000/00/POR/INF/22/T: PROVISION OF MAINTENANCE ON VARIOUS PROVINCIAL ROADS OVER A PERIOD OF 36 MONTHS WITHIN UMZUMBE SOUTHERN ZONE 1 UNDER COST CENTRE PORT SHEPSTONE IN THE DURBAN REGION.

TENDER SUMMARY

DESCRIPTION	AMOUNT
Totals of Bill of Quantities brought forward:	
Schedule A: Roadworks (b/f from page C48)	R
Schedule E: Expanded Public Works Programme (b/f from page C50)	R
Schedule F: Small Contractor Development (b/f from page C53)	R
SUBTOTAL 1	R
PART G: CONTRACT SKILLS DEVELOPMENT GOALS – CSDG (0.25% of SUBTOTAL 1	R
SUBTOTAL 2(SUBTOTAL 1 +CSDG)	R
<u>Add: Contingencies (10% of SUBTOTAL 2)</u>	R
SUBTOTAL 3(SUBTOTAL 2 + CONTINGENCIES)	R
<u>Add: Contract Price Adjustment-CPA (12% of SUBTOTAL 3)</u>	R
<u>Add: VAT (15% of SUBTOTAL3 +CPA)</u>	R
TOTAL CARRIED FORWARD TO FORM OF OFFER C1.1.1	R

Signed on behalf of the Tenderer: (Signature)

Date:

Tenderer's Name: (Company Name)

SCHEDULE G: CONTRACT SKILLS DEVELOPMENT GOAL (CSDG)

ITEM	DESCRIPTION	UNIT	QTY	RATE	AMOUNT R
G	CONTRACT SKILLS DEVELOPMENT GOAL (CSDG)				
G7.01	Payments associated with the Contract Skills Development Goals:				
	(a) Employment of Leaners employed under Method 1				
	(i) Provision for stipends	Prov sum			
	(ii) Provision for additional Costs	Prov sum			
	(b) Employment of Leaners employed under Method 2				
	(i) Provision for stipends	Prov sum			
	(ii) Provision for additional Costs	Prov sum			
	(c) Employment of Leaners employed under Method 3				
	(i) Provision for stipends	Prov sum			
	(ii) Provision for mentorship	Prov sum			
	(iii) Provision for additional Costs	Prov sum			
	(d) Employment of Candidates employed under Method 4				
	(i) Provision for stipends	Prov sum			
	(ii) Provision for mentorship	Prov sum			
	(iii) Provision for additional Costs	Prov sum			
	(e) Liaison with the Employer's project manager and the training service provider:				
	(i) Liaison conducted by the Construction Manager	hr			
TOTAL BROUGHT FORWARD FROM SUMMARY (CSDG 0.25%)					

PART C3: SCOPE OF WORK

<u>TABLE OF CONTENTS</u>	PAGE
C3.1 STANDARD SPECIFICATIONS	C57
C3.2 PROJECT SPECIFICATIONS	C58
PART A: GENERAL	
1. DESCRIPTION OF THE WORKS	C58
2. DRAWINGS.....	C70
3. PROCUREMENT	C70
4. CONSTRUCTION	C70
5. MANAGEMENT.....	C71
PART B: AMENDMENTS TO THE STANDARD SPECIFICATIONS	
PROJECT SPECIFICATIONS RELATING TO THE STANDARD SPECIFICATIONS AND OTHER ADDITIONAL SPECIFICATIONS	C75
C3.3 PARTICULAR SPECIFICATIONS	
PART C: ENVIRONMENTAL MANAGEMENT SPECIFICATION.....	C89
PART D: OHSA 1993 HEALTH AND SAFETY SPECIFICATION	C95
PART E: EXPANDED PUBLIC WORKS PROGRAMME.....	C104
PART F: SMALL CONTRACTOR DEVELOPMENT	C139
PART G: CONTRACT SKILLS DEVELOPMENT GOAL	C184

C3.1: STANDARD SPECIFICATIONS

The Standard Specifications on which this contract is based are the '**Standard Specifications for Road and Bridge Works for South African Road Authorities (COTO), Draft Standard (DS), October 2020**'.

C3.2: PROJECT SPECIFICATIONS

The Project Specifications, consisting of two parts, form an integral part of the Contract and supplement the Standard Specifications.

Part A contains a general description of the Works, the Site and the requirements to be met.

Part B contains variations, amendments and additions to the Standard Specifications and, if applicable, the Particular Specifications.

In the event of any discrepancy between a part or parts of the Standard or Particular Specifications and the Project Specifications, the Project Specifications shall take precedence. In the event of a discrepancy between the Specifications (including the Project Specifications) and the drawings and / or the Bill of Quantities, the discrepancy shall be resolved by the Employer's Agent before the execution of the work under the relevant item.

The Standard Specifications, which form part of this contract, have been written to cover all phases of work normally required for road contracts, and they may therefore cover items not applicable to this particular contract.

C3.2: PROJECT SPECIFICATIONS

PART A: GENERAL

1. DESCRIPTION OF THE WORKS

1.1 Employer's objectives

This Project forms part of the Province of KwaZulu-Natal Department of Transport's Routine Maintenance Programme. This Contract represents the implementation of routine and safety maintenance activities on various roads within Umzumbe Southern Zone 1 over a three-year period (2024 to 2026). The main contractor, based on the contractual agreements, must subcontract a minimum of 30% of the works to local emerging contractors.

The contract is located in a region of KwaZulu-Natal that has been historically impoverished by a lack of infrastructure access. It is therefore mandatory that the Contractor shall interact with the community via proactive project liaison with and project participation by its leaders and constituted organisations and forums, as well as through the employment of its people, and these activities shall constitute essential facets of the project.

The Employer's objectives in delivering public infrastructure and services for this project include the provision of temporary work opportunities to the local community through the application of labour-intensive construction methods to the maximum extent feasible, in accordance with the Expanded Public Works Programme Guidelines.

The Contractor shall be required to attend meetings of the local Project Liaison Committee (PLC) from time to time. The requirements of the Expanded Public Works Programme (EPWP) are contained in Part F of section C3.3 Particular Specifications. These EPWP requirements also include provisions for the National Youth Service programme where applicable.

The requirements in terms of the CIDB B.U.I.L.D Programme with respect to Indirect Targeting for Enterprise Development are contained in PART F of section C3.3 Particular Specifications. The requirements in terms of the CIDB B.U.I.L.D Programme with respect to Skills Development are contained in PART G of section C3.3 Particular Specifications.

The Contractor shall be required to undertake maintenance activities of the newly constructed road for this contract during the defect liability period, as per the provisions of PSA 1.2.3.15 in the Project Specifications.

1.2 Location of the Works

The project is located in the Umzumbe Local Municipality area. Contained below is the locality map of the work area:

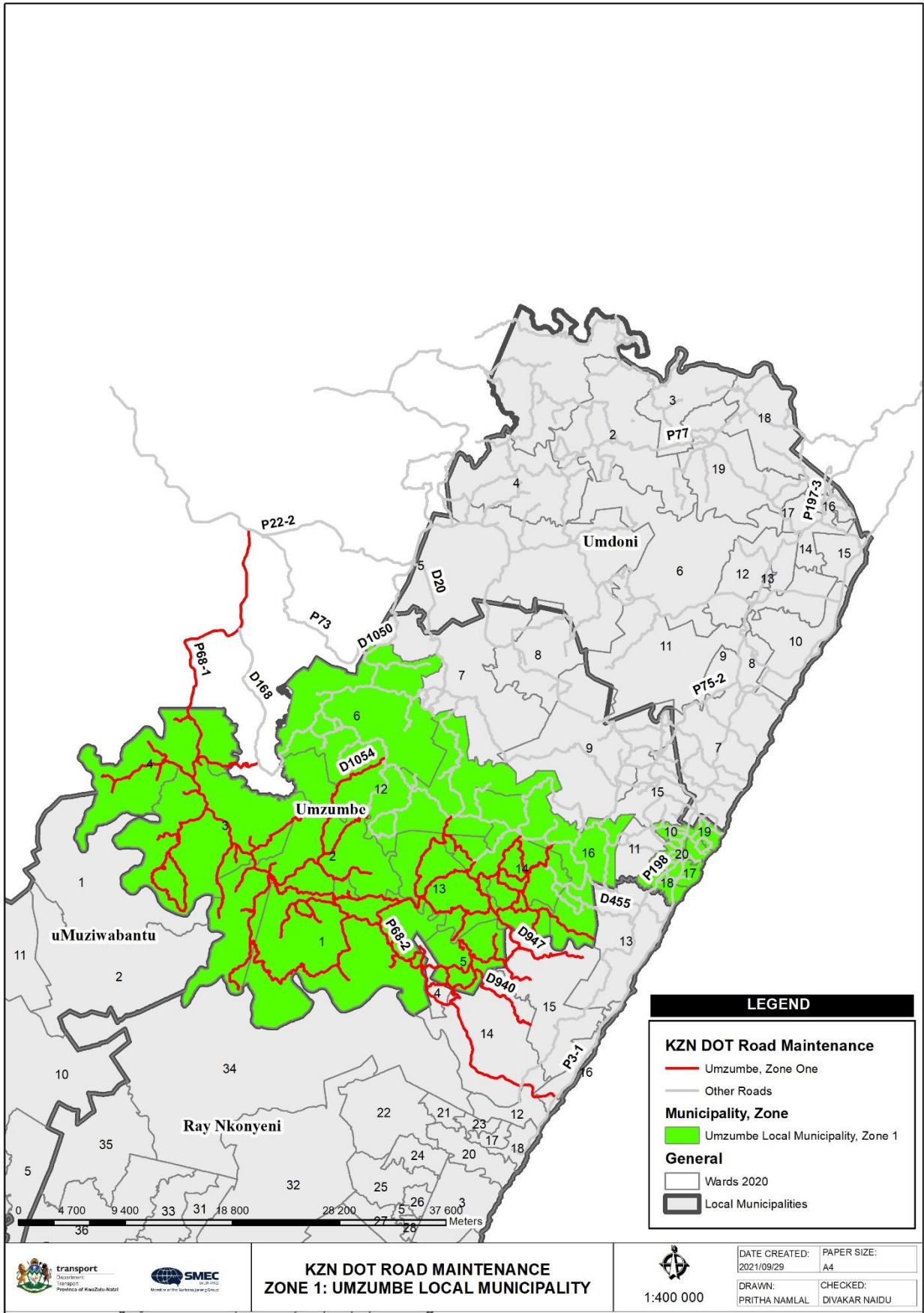

It is envisaged that Umzumbe and Umdoni Municipal areas will be divided into four Zones. The Contractor may tender for any or all the Zones.

The Contractor will be instructed to undertake work in a zone under which he is appointed but may also be required to undertake work from the following list of roads which are under the Department's jurisdiction in Umzumbe Municipality.

ROAD KEY	ROAD NUMBER	CLASS	KZ	MUNICIPAL NAME	Km
2388	D1045	D	KZN213	Umzumbe	7,48
3388	D1054	D	KZN213	Umzumbe	12,51
2401	D1057	D	KZN213	Umzumbe	16,15
2419	D1074	D	KZN213	Umzumbe	6,37
2420	D1075	D	KZN213	Umzumbe	8,73
2421	D1076	D	KZN213	Umzumbe	2,81
2445	D1099	D	KZN213	Umzumbe	3,52
2459	D1113	D	KZN213	Umzumbe	5,47
2461	D1115	D	KZN213	Umzumbe	10,22
2465	D1119	D	KZN213	Umzumbe	9,73
2467	D1121	D	KZN213	Umzumbe	12,42
3747	D168	D	KZN213	Umzumbe	24,03
4485	D2105	D	KZN213	Umzumbe	1,81
4486	D2106	D	KZN213	Umzumbe	2,48
4487	D2107	D	KZN213	Umzumbe	2,58
4488	D2108	D	KZN213	Umzumbe	5,78
4491	D2114	D	KZN213	Umzumbe	2,33
4494	D2118	D	KZN213	Umzumbe	2,08
4535	D2191	D	KZN213	Umzumbe	3,52
8136	D2478	D	KZN213	Umzumbe	7,95
8255	D2480	D	KZN213	Umzumbe	5,44
1068	D454	D	KZN213	Umzumbe	4,68
1069	D455	D	KZN213	Umzumbe	5,15
2059	D859	D	KZN213	Umzumbe	20,90
3386	D895	D	KZN213	Umzumbe	12,65
2257	D921	D	KZN213	Umzumbe	13,03
2258	D922	D	KZN213	Umzumbe	1,81
2259	D923	D	KZN213	Umzumbe	12,71
2260	D924	D	KZN213	Umzumbe	7,63
2261	D925	D	KZN213	Umzumbe	7,36
2264	D928	D	KZN213	Umzumbe	9,81
2265	D929	D	KZN213	Umzumbe	3,12
2267	D931	D	KZN213	Umzumbe	4,79
2268	D932	D	KZN213	Umzumbe	16,56
2269	D933	D	KZN213	Umzumbe	6,27
2270	D934	D	KZN213	Umzumbe	6,30
2271	D935	D	KZN213	Umzumbe	2,78
2273	D937	D	KZN213	Umzumbe	1,66
2274	D938	D	KZN213	Umzumbe	8,24

ROAD KEY	ROAD NUMBER	CLASS	KZ	MUNICIPAL NAME	Km
2275	D939	D	KZN213	Umzumbe	5,62
2276	D940	D	KZN213	Umzumbe	9,69
2277	D941	D	KZN213	Umzumbe	12,19
2279	D943	D	KZN213	Umzumbe	3,83
2281	D945	D	KZN213	Umzumbe	3,65
2282	D946	D	KZN213	Umzumbe	9,18
2283	D947	D	KZN213	Umzumbe	11,94
2284	D948	D	KZN213	Umzumbe	3,47
2285	D949	D	KZN213	Umzumbe	11,03
2286	D950	D	KZN213	Umzumbe	16,05
2287	D951	D	KZN213	Umzumbe	3,24
2288	D952	D	KZN213	Umzumbe	0,41
2289	D953	D	KZN213	Umzumbe	2,28
2290	D954	D	KZN213	Umzumbe	3,16
2291	D955	D	KZN213	Umzumbe	25,19
2292	D956	D	KZN213	Umzumbe	1,75
100457	G_D941	G	KZN213	Umzumbe	0,10
4661	L1016	L	KZN213	Umzumbe	5,72
4662	L1017	L	KZN213	Umzumbe	3,26
4663	L1018	L	KZN213	Umzumbe	3,98
4664	L1019	L	KZN213	Umzumbe	3,07
4666	L1020	L	KZN213	Umzumbe	1,26
4669	L1023	L	KZN213	Umzumbe	2,18
4675	L1031	L	KZN213	Umzumbe	0,49
4704	L1071	L	KZN213	Umzumbe	2,22
4705	L1074	L	KZN213	Umzumbe	5,50
4706	L1075	L	KZN213	Umzumbe	3,96
4707	L1076	L	KZN213	Umzumbe	5,27
6265	L1086	L	KZN213	Umzumbe	1,68
4877	L1284	L	KZN213	Umzumbe	1,44
5163	L1813	L	KZN213	Umzumbe	4,48
5164	L1814	L	KZN213	Umzumbe	3,74
5166	L1816	L	KZN213	Umzumbe	0,88
5167	L1817	L	KZN213	Umzumbe	3,02
5168	L1818	L	KZN213	Umzumbe	8,76
5170	L1820	L	KZN213	Umzumbe	8,96
5171	L1821	L	KZN213	Umzumbe	1,87
4490	L1920	L	KZN213	Umzumbe	3,96
6399	L1953	L	KZN213	Umzumbe	1,14
7471	L2448	L	KZN213	Umzumbe	2,19
7707	L2449	L	KZN213	Umzumbe	3,18
7536	L2456	L	KZN213	Umzumbe	0,66
7539	L2457	L	KZN213	Umzumbe	1,18
7560	L2458	L	KZN213	Umzumbe	3,84
7584	L2493	L	KZN213	Umzumbe	1,08

ROAD KEY	ROAD NUMBER	CLASS	KZ	MUNICIPAL NAME	Km
7585	L2494	L	KZN213	Umzumbe	2,39
7588	L2497	L	KZN213	Umzumbe	2,29
7590	L2499	L	KZN213	Umzumbe	2,24
7591	L2501	L	KZN213	Umzumbe	1,99
7592	L2502	L	KZN213	Umzumbe	1,03
8126	L2677	L	KZN213	Umzumbe	3,35
8127	L2678	L	KZN213	Umzumbe	1,57
8128	L2679	L	KZN213	Umzumbe	1,85
8134	L2680	L	KZN213	Umzumbe	1,84
8135	L2681	L	KZN213	Umzumbe	0,36
8133	L2682	L	KZN213	Umzumbe	5,44
8130	L2683	L	KZN213	Umzumbe	2,22
8129	L2684	L	KZN213	Umzumbe	3,87
8144	L2688	L	KZN213	Umzumbe	3,17
8138	L2690	L	KZN213	Umzumbe	3,03
8140	L2692	L	KZN213	Umzumbe	2,25
8137	L2693	L	KZN213	Umzumbe	0,89
8201	L2728	L	KZN213	Umzumbe	1,67
8203	L2729	L	KZN213	Umzumbe	1,48
8205	L2730	L	KZN213	Umzumbe	2,93
8204	L2731	L	KZN213	Umzumbe	1,61
8212	L2733	L	KZN213	Umzumbe	2,77
8207	L2734	L	KZN213	Umzumbe	1,63
8208	L2735	L	KZN213	Umzumbe	1,11
8210	L2736	L	KZN213	Umzumbe	2,44
8215	L2742	L	KZN213	Umzumbe	1,98
8252	L2778	L	KZN213	Umzumbe	0,46
8368	L2878	L	KZN213	Umzumbe	1,43
8369	L2879	L	KZN213	Umzumbe	4,03
8438	L2902	L	KZN213	Umzumbe	2,24
8427	L2942	L	KZN213	Umzumbe	1,71
8799	L3214	L	KZN213	Umzumbe	4,15
8798	L3215	L	KZN213	Umzumbe	2,04
8833	L3245	L	KZN213	Umzumbe	1,38
9001	L3386	L	KZN213	Umzumbe	7,49
3089	P198	P	KZN213	Umzumbe	32,60
998	P254-1	P	KZN213	Umzumbe	28,28
1106	P286	P	KZN213	Umzumbe	13,94
1184	P68-1	P	KZN213	Umzumbe	44,52
3088	P68-2	P	KZN213	Umzumbe	36,83
3630	P73	P	KZN213	Umzumbe	77,70
1099	P75-3	P	KZN213	Umzumbe	5,43

1.3 Overview of the Works

The Contract covers a number of construction and maintenance activities. The specific requirements for each project will be detailed by the relevant Regional Engineer or Client representative.

The Contractor will be responsible for the accommodation of traffic, for preparing the new or existing road for the work to be done and for clearing of site.

The Contractor may quote for any portion of the scheduled work or for any particular District where applicable.

1.4 Extent of the Works

The Works to be carried out include the following main activities:

- (a) Establishment on site and clearing and grubbing
- (b) Provision of traffic accommodation facilities
- (c) Survey requirements
- (d) Construction of pavement layers
- (e) Road prism drainage
- (f) Construction of erosion protection measures (gabions, stone pitching, concrete drains, etc.)
- (g) Installation of guardrails.
- (h) Bridge Repairs
- (i) Pothole Repairs and cracks sealing
- (j) Blading and Patching of gravel roads
- (k) Grass cutting
- (l) Clearing of Drains and waterways, Kerbs and channeling and v drains
- (m) Litter collection
- (n) Construction of Speed humps and rumble strips
- (o) Road Markings
- (p) Road Signs and Kilometre marker posts
- (q) Handrail Repairs
- (r) Washaway repairs
- (s) Concrete Pavements
- (t) Finishing and cleaning up of the road and road reserve.
- (u) Continuous quality control over materials and workmanship, and compliance with the Particular Specifications with regard to environmental management and occupational health and safety, during all the above construction activities.
- (v) Removal of all site establishment facilities and constructional plant on completion of the Works.
- (w) Making good of any defects during the Defects Liability Period.

1.5 Detailed description of the Works

The following description is a broad outline of the works and does not limit the work to be executed by the Contractor in terms of the contract. The description of some of the major items indicated in this section are indicative, not absolute, and are provided to define in general terms the overall scope of the project.

No approximate quantities of each type of work to be carried out in accordance with the contract documents are listed in the Schedule of Quantities on the following tables.

The site shall not only comprise the proclaimed road reserve but shall be extended in the broader sense to take account of all areas occupied by the Contractor, be it deliberate or unintentional, in the execution of the contract. The site includes all the land within the proclaimed limits of the road reserve along the extent of the works, borrow pits and quarry sites, stockpile areas, locations set aside for construction and supervision accommodation and any other location required for the execution of the Works.

Incidental intrusion into private or tribal property outside the road reserve shall not be permitted without the

owner's written authority. Any such agreement reached with a private or tribal landowner (occupier) shall include the proviso that any material or equipment on that site shall remain the exclusive property of the Employer in terms of the contract.

The Department requires the contractors to establish the necessary machines and personnel to carry out the extent of all the works. This includes the routine and safety maintenance work that is to be completed as confirmed with the Employers Agent prior to commencement.

The contractor is responsible for all traffic control and safety in the area of the works. One lane must be available to the travelling public at all times and the maximum length of roadway to be under construction at any one time is 5 kilometres. At night all obstructions must be removed and the necessary signs such as no lines, loose stones, speed limits, etc must be left on the site to ensure that the travelling public are safe. Some of these signs will need to be left on the road until such time that the road marking has been completed.

The site camp and aggregate stock pile sites must be cleared and cleaned to the satisfaction of the Department or its representative. This must include excess stone in the drainage elements. Spilt bitumen and the cut off paper must be suitably disposed of at a registered waste disposal dump or as set out in the Environmental Management Plan.

1.5.1 Access to the Site

Due to the nature of the project and having multiple site locations, access to site will be confirmed with the Employers Agent during the course of the project

Throughout the duration of the contract, Roads shall be shared with other contractors engaged by the KwaZulu-Natal Department of Transport on the identified projects whose construction activities may affect access from time to time. The Contractor shall therefore be required to liaise on an ongoing basis with these other contractors with respect to access related matters throughout the duration of the contract.

1.5.2 Demolition work

The Contractor is not required to carry out any demolition work to existing structures.

1.5.3 Spoiling of surplus material

Surplus material shall be spoiled in designated areas approved by the Employer's Agent. The spoil material shall be disposed of in accordance with subclause A4.1.7.2 (i) of the COTO Standard Specifications for Road and Bridge Works for South African Road Authorities (COTO), Draft Standard (DS), October 2020

1.5.4 Quantities

The approximate leading quantities for the permanent Works to be constructed is indicated in the Bill of Quantities.

1.5.5 Material investigations

Materials information is furnished in section C4.4 at the end of this document.

1.5.6 Material sources, spoil and stockpile areas

The material for the G2 base and all concrete materials shall be obtained from commercial sources.

Spoil areas and areas for the temporary stockpiling of construction materials shall be determined and agreed on site in conjunction with the Employer's Agent, the PLC (where applicable) and the local communities (where applicable). The Contractor shall be permitted to use only these agreed spoil and stockpile areas, which shall be landscaped and vegetated on completion of the work.

Where possible, the contractor shall source material from within 60 km the site utilizing local labour.

1.5.7 Accommodation of traffic

All works adjacent to the road shall always be constructed in such a manner as to allow the safe passage of traffic. The contractor shall keep the Engineer and the regional traffic police fully informed of any temporary changes required in the normal traffic flow and shall obtain their approval for these changes.

The contractor shall nominate a member of his staff as site safety officer with specific responsibilities. The accommodation of such traffic can be on the existing road, on deviations or on both.

The travelling public has the right of way on all public roads. The contractor shall employ suitable, approved methods to control the movement of his equipment in such a way that the travelling public is not endangered.

The Engineer has the right to stop the works should the contractor fail to erect and maintain traffic signs and warning signs. Such stoppage of the works shall continue until the Engineer is satisfied that the necessary items have been erected and that the defective items have been repaired or replaced.

All temporary road signs, devices, sequences, layouts and spacing shall also comply with the requirements set out in the Road Traffic Act, (Act 29 of 1989) and its Regulations, the requirements of the relevant authority and the drawings.

The overall responsibility of ensuring that adequate temporary traffic control and safety measure are in place at all times shall be that of the contractor.

The contractor shall inspect all traffic control facilities at least once daily and immediately make good any shortcomings. The contractor shall indemnify the Employer and Engineer against all proceedings, claims, damages and costs which may arise from or be related to the absence of traffic control facilities.

The sub-contractors will have to include traffic accommodation in their tendered rates, unless it has been agreed with the Main Contractor to provide traffic accommodation.

1.5.8 Accommodation of other contractors

In addition to the requirements of Clause 5.4.2 of the General Conditions of Contract for Construction Works 2015, the Contractor must take note of the presence of other Contractors on site and make allowance for them in site. This may involve adapting the Contractor's Program to accommodate the work of other Contractors and ensuring their access to site.

1.5.9 Existing services

The Contractor shall make himself acquainted with the position of all existing services before any excavations or other work likely to affect the existing services has commenced. The Contractor will be held responsible for any damage to known existing services caused by or arising out of his operations and any damage shall be made good at his own expense. Damage to unknown services shall be repaired as soon as possible and liability shall be determined on site when such damage should occur.

Prior to commencing construction activities in a particular area, the Contractor shall also diligently enquire of local landowners as to whether there are any other known services which have not been shown on the drawings but which may be affected by the construction activities in that area, and any such services shall be brought to the attention of the Engineer immediately. The Contractor shall take note of the requirements of clause 1202 of the standard specifications with regard to services

1.5.10 Employer's Agent's site offices and laboratory

The Contractor shall be required to provide furnished site office facilities, laboratory facilities, ablution facilities, and carpools for the Employer's Agent at a site located in close proximity to the Contractor's office establishment and to the Works. A possible area for such site establishment shall be indicated at the Site

Clarification Meeting.

1.5.11 Climate

The road is located in a high summer rainfall region with a 30 year mean annual precipitation of 750 mm.

1.5.12 Environment

The Contractor's attention is called to clause A1.2.3.3 of Standard Specifications for Road and Bridge Works for South African Road Authorities (COTO), Draft Standard (DS), October 2020 and to the requirements of Part C: Environmental Management Specification contained in section C3.3 Particular Specifications.

1.5.13 Labour

A Project Liaison Committee (PLC) has been established and is a vital means of communication between all parties involved with the project. The composition of the PLC comprises representatives of the Employer, the Employer's Agent and formal structures within the community.

The Contractor shall make use of these communication channels, and shall appoint from amongst his site personnel a responsible person to participate in the affairs of the PLC, and this representative will be also required to attend the monthly PLC meetings.

It is mandatory that the Contractor shall interact with the community via proactive project liaison and project participation by its leaders and constituted organisations and forums, as well as through the employment of its people, and these activities shall constitute essential facets of the project.

Local labour is to be used and the employment of such labour is to be done in conjunction with the PLC. The PLC has formed a Labour Committee who shall assist the Contractor with the recruitment of local labourers to ensure an equal distribution of people employed between the various Amakhosi in the area.

1.5.14 Labour-enhanced construction methods

Labour enhanced construction shall mean the economically efficient employment of as great a portion of local labour as is technically feasible to produce a standard of construction as demanded by the specifications with completion by the Due Completion Date, where local labour is the primary resource, supported by plant for activities that cannot be carried out feasibly by labour only.

Labour enhanced construction activities are to be planned as task-based work as a general rule. A task means a fixed quantity of work, to be performed to a clearly defined quality. Task-based work means work in which a worker is paid a fixed rate for performing a task, which is clearly defined in terms of quantity and quality. Typically, a particular task can be completed within a working day.

Appropriate portions of the Works included in the Contract shall be carried out using labour enhanced construction methods.

Except where the use of equipment is essential in order, in the opinion of the Employer's Agent, to meet the specified requirements by the Due Completion Date, or where the use of equipment is essential as a result of occupational health and safety considerations, the Contractor shall use only hand tools and equipment in the construction of those portions of the Works that are required in terms of these Project Specifications to be constructed using labour enhanced construction methods.

Such portions of the Works shall be constructed utilizing only the local labour of the Contractor and/or the local labour of subcontractors, supplemented by the Contractor's key personnel to the extent necessary and unavoidable, unless otherwise instructed by the Employer's Agent and in accordance with the further provisions of the relevant sections of Part B of the Project Specifications.

Subject to considerations of occupational health and safety, and subject to the nature of the in situ materials being such that they can be excavated efficiently by hand, the portions of the Works to be carried out under supervision using labour enhanced construction methods are listed under the labour enhanced item numbers as per COTO -Draft Standard(DS) October 2020 specifications in the bill of quantities, include, but are not limited to, the following:

- Erection of the Contractor's and Employer's Agent's site establishment facilities;
- Provision of domestic services at the site establishment facilities;
- Provision of flagmen and labour for erecting traffic accommodation facilities;
- Clearing of the Site;
- Excavation for structures and open drains up to 1,5 m deep where the depth of the water table permits such excavation to be carried out safely, and the subsequent backfilling thereof;
- Bedding, selected fill, backfilling and compaction of all trenches for prefabricated culverts irrespective of depth, but assisted by mechanical compaction equipment in order to achieve the specified densities;
- Transportation and spoiling of all trench materials, where the disposal site is located within 20 metres of the source;
- Mixing and placing of concrete for the channel and backing to the prefabricated kerbs;
- Mixing and placing of concrete for concrete lined drains and sidewalks;
- Mixing and placing of concrete for minor drainage structures and road furniture structures;
- Mixing and placing of concrete for concrete edge beams at gravel road access points;
- Installation of prefabricated kerbs;
- Construction of all brickwork required for drainage structures and manholes;
- Erection of falsework and formwork;
- Fixing of reinforcement;
- Spreading of offloaded earthworks materials to the extent scheduled;
- Spreading of offloaded pavement layers materials to the extent scheduled;
- Spreading of stabilising agent;
- Maintenance patching of surfacing;
- Slurry seal surfacing;
- Excavation for and construction of stone pitching, and subsequent backfilling;
- Excavation for and construction of gabion boxes and mattresses, and subsequent backfilling;
- Dismantling / erection of fences;
- Excavation and subsequent backfilling for guardrail;
- Dismantling / erection of guardrail;
- Excavation and subsequent backfilling for road signs;
- Dismantling / erection of road signs;
- Spreading of topsoil;
- Planting of grass cuttings, grass sodding and hand sowing of grass seeds; and
- Cleaning and tidying up of the Site.

In respect of those portions of the Works which are not listed above, the construction methods adopted and the equipment utilized shall be at the discretion of the Contractor, provided always that the construction methods adopted and the equipment utilized by the Contractor are appropriate in respect of the nature of the Works to be executed and the standards to be achieved in terms of the Contract.

1.6 Temporary Works

The Temporary Works required under this Contract shall include the traffic accommodation measures implemented, the provision of drainage control, falsework and formwork during the construction of the minor drainage structures, and the provision of any scaffolding or temporary propping used during the erection of the road signs.

All Temporary Works shall be removed from the Site on completion of the Contract.

1.7 Maintenance of the Works during the construction period

The Contractor shall take note of the various requirements of the General Conditions of Contract 2015 and the Standard Specifications for Road and Bridge Works for South African Road Authorities (COTO), Draft Standard (DS), October 2020 with respect to the care and protection of the Works.

The handing-over of the road reserve for this contract is described in clause A1.2.3 of Standard Specifications for Road and Bridge Works for South African Road Authorities (COTO), Draft Standard (DS), October 2020. The Contractor shall be responsible for maintaining this portion of the road from the date of hand-over until the issue of the Certificate of Practical Completion.

1.8 Testing of materials

A prime cost sum has been allowed in chapter 20 of the Bill of Quantities for all acceptance control testing laboratory work to be carried out by the Employer's Agent using the laboratory facilities which may include and/or commercial laboratory facilities.

The Contractor shall carry out at his own cost the required process control testing as specified in terms of the Standard Specifications for Road and Bridge Works for South African Road Authorities (COTO), Draft Standard (DS), October 2020.

1.9 Power supply and other services

The Contractor shall make his own arrangements concerning the supply of electrical power and all other services. No direct payment shall be made for the provision of electrical and other services. The cost thereof shall be deemed to be included in the rates and amounts tendered for the various items of work for which these services are required.

1.10 Construction in confined areas

It may be necessary for the Contractor to work within confined areas. Except where provided for in the specifications, no additional payment shall be made for work done in restricted areas. In certain places the width of the fill material and pavement layers may decrease to zero and the working space may be confined. The method of construction in these confined areas largely depends on the Contractor's constructional plant. However, the Contractor shall note that, unless otherwise provided for in terms of the scheduled payment items in the Standard Specifications for Road and Bridge Works for South African Road Authorities (COTO), Draft Standard (DS), October 2020 or these project specifications, measurement and payment shall be in accordance with the specified cross sections and dimensions only, irrespective of the method used for achieving these cross sections and dimensions, and that the tendered rates and amounts shall include full compensation for all special equipment and construction methods and for all difficulties encountered when working in confined areas and narrow widths, and at or around obstructions, and that no extra payment shall be made nor shall any claim for additional payment be considered in such cases.

1.11 Contractor's campsite (Project Specific)

Possible locations for a campsite shall be pointed out at the clarification meeting. (Project Specific Clarification meetings)

The Contractor shall make his own arrangements for the provision of his campsite and housing for construction personnel but the chosen site shall be subject to the approval of the Employer's Agent, the local authorities and, where applicable, the Project Liaison Committee (PLC) associated with the project.

The standard of the Contractor's camp, offices, accommodation, ablution, and other facilities must comply with the requirements of all local authority, environmental and industrial regulations concerned. In establishing and maintaining his campsite, due cognisance is to be taken of the requirements of clause A1.3.3 of the Standard Specifications for Road and Bridge Works for South African Road Authorities (COTO), Draft Standard (DS), October 2020.

The Contractor is to fully familiarise himself with all local by-laws and Government regulations for the employment, transport and accommodation of labour on site.

The Contractor shall particularly note that there is a high risk of theft, vandalism and damage to property in this area and strict security will be required for all plant, establishment, temporary works and partially completed works. The Contractor shall be responsible for providing security for all plant, establishment, temporary works and partially completed works. No separate payment shall be made for the provision of such security since full compensation for these costs shall be deemed to be included in the amount tendered for item C1.3.1.3 (The contractor's general obligations: Time-related obligations).

1.12 Additional requirements for construction activities

The travelling public shall have the right of way on public roads, and the Contractor shall make use of

approved methods to control the movement of his equipment and vehicles so as not to constitute a hazard on the road.

The Contractor's tendered rates shall include full compensation for all costs which may arise from the construction and maintenance of deviations and construction under traffic. No claim for additional costs which may arise from these methods of traffic accommodation and no additional payment owing to inconvenience as a result of the Contractor's method of working shall be considered.

It is a condition of this Contract that the employer reserves the right to limit the total expenditure on the works due to possible budget constraints. Should the tender sum exceed the budgeted amount, the scope of works may be reduced at any time before or during the contract period to ensure that the final contract amount does not exceed the budgeted amount.

1.13 Construction programme

The Contractor shall submit a detailed time programme in accordance with clause 5.6.2 of the General Conditions of Contract 2015, clause A1.2.7 of the Standard Specifications for Road and Bridge Works for South African Road Authorities (COTO), Draft Standard (DS), October 2020.

In addition to any other restrictions accommodated by the Contractor in compiling the construction programme, the following constraints shall be taken into account in the preparation thereof:

- (a) The whole of the Works (and the portions of the Works if completion in portions is required) shall be completed within the time period(s) stated (refer to the Contract Data in section C1.2.2).
- (b) Working days lost due to abnormal rainfall shall be treated as set out in clause A1.2.3.4 (b)
- (c) Allowance shall be made for non-working days and special non-working days (refer to the Contract Data in section C1.2.2).
- (d) Construction activities must comply with all the specified environmental requirements including clause A1.2.3.3 of Standard Specifications for Road and Bridge Works for South African Road Authorities (COTO), Draft Standard (DS), October 2020 and the requirements of Part C: Environmental Management Specification contained in section C3.3 Particular Specifications.
- (e) Construction activities must comply with all the specified health and safety obligations including the requirements of Part D: OHS 1993 Health and Safety Specification contained in section C3.3 Particular Specifications.
- (f) Strict control of access to and from local public roads shall be required when construction vehicles, plant or equipment leave or enter the site.
- (g) Throughout the contract period traffic must be accommodated through the site and all other contractors engaged on the construction of identified roads must be accommodated.
- (h) The Contractor's programme of work shall take due cognisance of risks by limiting the duration of the exposure of the various construction elements to natural phenomena.

PRELIMINARY CONSTRUCTION PROGRAMME

Not Applicable

2. DRAWINGS

The drawings that form part of the Tender documents are issued on a CD and shall be used for Tender purposes only.

The Contractor will be supplied with three complete sets of A0 paper print drawings, and one set of drawings on a CD. These A0 paper prints and CD are issued free of charge and the Contractor shall make any additional copies he may require at his own cost.

Any information in the possession of the Contractor which the Employer's Agent requires to complete the as-built drawings shall be supplied to the Employer's Agent before a certificate of completion will be issued.

Only figured dimensions shall be used and drawings shall not be scaled unless so instructed by the Employer's Agent. The Employer's Agent will supply all figures / dimensions omitted from the drawings.

The levels given on the drawings are subject to confirmation on site, and the Contractor shall submit all levels to the Employer's Agent for confirmation before he commences any structural construction work. The Contractor shall also check all clearances given on the drawings and shall inform the Employer's Agent of any discrepancies.

3. PROCUREMENT

The contractor shall procure goods and services under provisional sums and prime cost sums according to the Employer's standards.

4. CONSTRUCTION

4.1 Applicable SANS 2001 standards for construction work

All construction work must conform with the relevant SABS or SANS specifications referred to in the 'Standard Specifications for Road and Bridge Works for South African Road Authorities (COTO), Draft Standard (DS), October 2020', or in Section C3.2 Project Specifications, Part B: Amendments to the Standard Specifications, of this document.

4.2 Applicable national and international standards

All construction work must be undertaken in accordance with the 'Standard Specifications for Road and Bridge Works for South African Road Authorities (COTO), Draft Standard (DS), October 2020 and as amended in Section C3.2 Project Specifications, Part B: Amendments to the Standard Specifications, of this document.

4.3 Particular / generic specifications

As well as the 'Amendments to the Standard Specifications' contained in Part B of Section C3.2 Project Specifications, of this document, the following Particular Specifications as contained in Section C3.3, are applicable to this Contract:

- Part C: Environmental Management Specification
- Part D: OHS 1993 Health and Safety Specification
- Part E: Expanded Public Works Programme
- Part F: Small Contractor Development
- Part G: Contract Skills Development Goal

The 'General Conditions of Contract for Construction Works, Third Edition (2015)', published by the South African Institution of Civil Engineering which is applicable to this Contract.

4.4 Certification by recognized bodies

No certification of items included in the Works is required.

4.5 Plant and materials provided by the Employer

No plant and materials are to be provided by the Employer.

4.6 Services and facilities provided by the Employer

The Employer's Agent's site office and laboratory facilities will be paid for in terms of the Contract. No other services or facilities are to be provided by the Employer.

5. MANAGEMENT

5.1 Applicable SANS 1921 standards

The following parts of SANS 1921 and associated specification data are applicable:

5.1.1 SANS 1921-1 Part 1: General engineering and construction works

Specification data associated with SANS 1921-1	
Clause No.	Essential data
4.1.7	There are no requirements for drawings, information and calculations for which the Contractor is responsible.
4.2.1	The responsibility strategy assigned to the Contractor for the works is 'A'.
4.3.1	The programme must conform to clause A1.2.7.1 (Scheme 2) 'Programme of Work' of the Standard Specifications for Road and Bridge Works for South African Road Authorities (COTO), Draft Standard (DS), October 2020 and clause 5.6 'Programme' of the 'General Conditions of Contract 2015'.
4.3.3	The Contractor must give 24 hours' notice for inspection of work that is to be covered up.
4.7.3	Where applicable, the Contractor is afforded the opportunity of pricing an item to cover costs of unavoidable over-break.
4.12.2	The samples of materials, workmanship and finishes that the Contractor is to provide and deliver to the Employer/Employer's Agent are to be as described in clause A1.2.8 'Workmanship and Quality Control' of the Standard Specifications for Road and Bridge Works for South African Road Authorities (COTO), Draft Standard (DS), October 2020 and clause 7 'Quality and Related Matters' of the 'General Conditions of Contract 2015'.
4.12.2	The fabrication drawings that the Contractor is to provide to the Employer are: none.
4.14.5	The Contractor is to provide latrine and ablution facilities as described in Part C 'Environmental Management Plan' in Section C3.3 Particular Specifications of these Project Specifications.
4.14.6	The requirements for the provision and erection of signboards are as described in clause A1.2.3.10 'Notices, Signs and Advertisements' of the Standard Specifications for Road and Bridge Works for South African Road Authorities (COTO), Draft Standard (DS), October 2020, and as detailed in the 'Example of Contract Signboard Details' in Section C4: Site Information of these Project Specifications.
4.17.1	The requirements for the termination, diversion or maintenance of existing services are described in clause A1.2.7.3 and Chapter 2 of the Standard Specifications for Road and Bridge Works for South African Road Authorities (COTO), Draft Standard (DS), October 2020.
4.17.3	Services that are known to exist on the site are described in clause A1.2.7.3 and Chapter 2 of the Standard Specifications for Road and Bridge Works for South African Road Authorities (COTO), Draft Standard (DS), October 2020.
4.17.4	The requirements for detection apparatus for locating underground services are: none.
4.18	The additional health and safety requirements are described in Part D 'OHS 1993 Health and Safety Specification' in Section C3.3 Particular Specifications of these Project Specifications.

5.1.1.1 Additional clauses:

(a) Site meetings and procedures

Site meetings shall be convened as described in clause A1.2.3.16 'Monthly Site Meetings' of the Standard Specifications for Road and Bridge Works for South African Road Authorities (COTO), Draft Standard (DS), October 2020. The Contractor shall keep on site a set of minutes of all site meetings, daily records of resources (people and equipment employed), a site memoranda book, a complete set of contract working drawings and a copy of the procurement document, and shall make these available at all reasonable times to all persons concerned with the contract.

(b) Water and electricity

The Contractor is to provide water and electricity as described in clauses A1.2.3.21 'Water' and A1.4.7.3 'Services' of the Standard Specifications for Road and Bridge Works for South African Road Authorities (COTO), Draft Standard (DS), October 2020.

5.1.2 SANS 1921-6 Part 6: HIV/AIDS awareness

Specification data associated with SANS 1921-6	
Clause No.	Essential data
4.2.1(a)	A qualified service provider is one that is an accredited or provisionally accredited training service provider in the HIV/AIDS field. A list of accredited service providers can be obtained from the Construction SETA (CETA) (tel. 011 265 5900), Health and Welfare SETA (HWSETA) (011 622 6852) or on the Health and Welfare SETA website: www.hwseta.org.za .
4.2.1(a)	The HIV/AIDS awareness programme is to be repeated at four monthly intervals throughout the duration of the contract.

5.1.2.1 Additional clauses:

(a) Workshops

The duration of each workshop shall not be less than 2½ hours.

5.2 Recording of weather

The Contractor shall erect a rain gauge and record the rainfall as described in clause A1.2.3.4 of the Standard Specifications for Road and Bridge Works for South African Road Authorities (COTO), Draft Standard (DS), October 2020. This information together with other details of the prevailing weather conditions shall be recorded in the daily site diary.

5.3 Unauthorised persons

The Contractor shall keep unauthorised persons away from the Works at all times. Under no circumstances may the Contractor's personnel be accommodated on the site.

5.4 Management meetings

Management meetings are to be held weekly at a time convenient to all concerned, to discuss planning and health and safety amongst other things. Attendance by the Construction Manager and the Employer's Agent's Representatives on site is mandatory, and attendance by other interested parties will be by invitation.

5.5 Forms for contract administration

The Employer's Agent's Representative will provide standard forms for 'Site Diary', 'Site Memoranda', 'Requests for Inspection' and any others deemed to be necessary during the contract.

5.6 Electronic payments

Payments of approved payment claims will be made electronically upon submission of the Contractor's banking details.

5.7 Daily records

A site diary is to be compiled jointly by the Construction Manager and the Employer's Agent's Representatives on site and is to be agreed and signed by both parties. The original signed copy is to be retained by the Employer's Agent's Representative.

The Contractor is to keep daily records of people and equipment on site in a format to be agreed by the Employer's Agent's Representative, and is to provide copies to the Employer's Agent's Representative when requested.

5.8 Payment certificates

The contractor shall submit the following on a monthly basis to the Engineer in order to assist with the processing of the payment certificate and the preparation of CPG and EPWP.

- A detailed breakdown of the work done. (The work breakdown must be referenced strictly in accordance with the detailed priced bill of quantities and must be signed by contractor and resident engineer).
- A detailed breakdown of all variation order costs claimed (with specific reference to work done by the contractor) in the certificate concerned, together with copies of relevant contract instruction.
- A detailed breakdown of the work done by the CPG contractor. (The work breakdown must be referenced strictly in accordance with the detailed priced bills of quantities, as applicable).
- A written declaration authenticated by the Professional Contracts Manager/Engineer confirming, that the payment claims for work done by CPG contractor has been audited and amended by the contractor, prior to it being forwarded to the Engineer for evaluation.
- If applicable, a combined CPG and EPWP report which shall include reports on contractor and CPG contractor compliance, in accordance with the format required by the Engineer. In this regard, the combined, contractor and CPG contractor report must contain an affidavit certifying that all information contained the report as being true and correct.
- Proof of payment for items contained in provisional sums, proof of ownership of materials on site and documentation pertaining to contract price adjustment and special materials, are required as substantiation of claims for payment.
- Tax invoice: The contractor shall attach a tax invoice as prescribed in the value added Tax legislation to each payment certificate when presenting the certificate to the employer for payment. Such tax invoice shall correctly reflect the prescribed information and the amounts included in the payment certificate. Should the contractor fail to comply with these requirements, the date of presentation of the certificate shall be deemed to be delayed at the contractor's default until such time as the requirements are met.
- All work claimed by CPG contractor must be submitted in a form of a certificate directed to the main contractor with all necessary backups supporting items claimed for, and must be certified and / or accepted by the main contractor and Engineer's Representative for invoice.

Should anyone or any combination of the above requirements not be complied with, the engineer reserves the right to exclude any amounts that may have been due for certification from payment certificate concerned and/or delay the issue of payment certificates and/or, revise the contractual payment date, as applicable, until such time compliance is achieved.

In addition, the Engineer requires seven (7) working days to process the payment certificate once all of the above requirements are met.

5.9 Permits

No security/entrance permits are required by the Contractor's personnel to enter the site.

5.10 Proof of compliance with the law

There are no requirements for the Contractor to verify compliance with any legislation.

5.11 Submission of reports

The contractor shall submit monthly reports in accordance with the specifications in Part E: Expanded Public Works Programme and Part F: Small Contractor Development.

C3.2: PROJECT SPECIFICATIONS

PART B: AMENDMENTS TO THE STANDARD SPECIFICATIONS

PROJECT SPECIFICATIONS RELATING TO THE STANDARD SPECIFICATIONS AND OTHER ADDITIONAL SPECIFICATIONS

In certain clauses in the Standard Specifications for Road and Bridge Works for South African Road Authorities (COTO), Draft Standard (DS), October 2020, allowance is made for a choice to be specified in the Project Specifications between alternative materials or methods of construction, and for additional requirements to be specified to suit a particular contract. Details of such alternatives or additional requirements applicable to this Contract are contained in this part of the Project Specifications. It also contains the necessary additional specifications required for this Contract.

The clauses and payment items dealt with in this part of the Project Specifications are numbered 'PS' with a number corresponding to the relevant clause or item number in the Standard Specifications for Road and Bridge Works for South African Road Authorities (COTO), Draft Standard (DS), October 2020.

New clauses and payment items not covered by clauses or items in the Standard Specifications for Road and Bridge Works for South African Road Authorities (COTO), Draft Standard (DS), October 2020 have been included here and have also been designated with the prefix 'PS'. Such clauses and items have been given a new number following upon the last number used in the particular chapter referred to in the Standard Specifications for Road and Bridge Works for South African Road Authorities (COTO), Draft Standard (DS), October 2020.

CHAPTER 1.2 GENERAL REQUIREMENTS AND PROVISIONS

PART A: SPECIFICATION

PSA1.2.3.4 EXTENSION OF TIME FOR DELAYS BY RAINFALL

Add the following to the end of A1.2.3.4 Clause A1.2.3.4(b) Method 2 (Critical-path method with consequential delays).

"The value of "n" working days expected delay caused by normal rainy weather as referred to in Method (ii) shall be as given in the table below for each respective calendar month of any year:

Month	Expected delay of "n" working days due to normal rainy weather	Month	Expected delay of "n" working days due to normal rainy weather
January***	5	July	1
February	4	August	1
March	4	September	2
April	3	October	3
May	2	November	4
June	1	December***	5

*** Includes the whole month of December / January.

PSA1.2.3.11 ORDERING OF DAYWORKS

Replace Clause A1.2.3.11 with the following:

PSA1.2.3.11 DAYWORKS

(a) Scope

Rates for daywork shall be entered in the under item C1.2.8.1 in accordance with the following specifications.

(b) Daywork Rates

According to Clause 6.5 of the General Conditions of Contract 2015, certain work may be carried out using rates tendered in the daywork schedule. A schedule of personnel, construction equipment and vehicles which may be required to perform work on a daywork basis is included in the Bill of Quantities. The quantities used in the Bill of Quantities are for tender evaluation purposes only and the use or not of these items shall not constitute a variation in terms of Clause 6.3 of the General Conditions of Contract 2015.

No work will be paid for as daywork without the written instruction or approval of the Employer's Agent.

(c) Type of Work

The Employer's Agent may order daywork in certain cases where it is necessary to vary or to extend the works due to new or unforeseen circumstances to such an extent that the tendered rates for specific items of work are no longer applicable, or where no suitable combination of tendered rates can be used to pay for such work.

As a general rule, applicable rates for additional work items will be agreed between the Contractor and the Employer's Agent. Daywork will only be used in exceptional circumstances.

(d) Materials

Materials for use in works carried out under daywork shall be purchased by the Contractor who shall also arrange for delivery to site, and shall be responsible for any other requirements associated with specific materials. A Provisional Sum has been allowed in C1.2.8 of the Bill of Quantities for daywork materials. The Contractor shall enter a tendered percentage in the Bill of Quantities to cover his handling costs and profit, as per other provisional and prime cost sums in this Contract.

Materials shall be paid for using the method described in C2.1, 'Pricing Assumptions'. No contract price adjustment will be applicable to materials.

The Contractor shall submit proof of ownership for any materials used in daywork with his daywork claim to the Employer's Agent. Further, if specific materials are required for daywork, quotations will be called for as per Clause 6.5.2 of the General Conditions of Contract 2015.

(e) Construction Equipment

Where daywork is ordered, the tendered rates for construction equipment in C1.2.8 of the Bill of Quantities shall be used in calculating the payment due for any construction equipment required to execute the daywork. If no rate is included in the Bill of Quantities for a particular item of construction equipment, and where no other rate or combination of rates would provide suitable compensation, then the daywork method of payment described in Clause 6.5.1.3 of the General Conditions of Contract 2015 will be used.

The tendered rates for each item of construction equipment shall include for all operating costs associated with the said item of construction equipment. Such costs are deemed to include fuel, re-fuelling costs, lubrication and routine servicing / maintenance, breakdowns and spares, all overhead costs, site management costs and administration costs. The tendered rates shall also include the construction equipment operator and the general supervision of the construction equipment while it is engaged in the daywork.

(f) Salaries and Wages of Workmen

The salaries and wages of workmen executing daywork shall be paid for using the tendered rates in the Bill of Quantities. The tendered rates shall include for all costs associated with the employment of personnel, including salaries, wages, allowances, workmen's compensation, medical aid and pension contributions, government levies and taxes, training costs and any costs associated with living on the site. The tendered rates shall also include for the transportation of the workmen to the site of the daywork.

All overhead costs, administration costs, site management costs and the Contractor's profit are deemed to be covered by the daywork rates and no additions or mark ups will be made to the tendered rates.

The tendered rates shall also include any hand tools normally associated with the workmen's job description e.g. picks, shovels, hammers, saws and spirit levels. The tendered rate for labourers shall also include for the casual supervision by a gang leader or foreman. Only when specifically called for by the Employer's Agent, will payment be made for the use of a gang leader or foreman supervising on a continuous basis.

(g) Measurement and Payment

The following principles shall also apply to the measurement and payment of daywork.

The unit of measurement for construction equipment shall be the number of Vibroclock hours worked and each item of construction equipment shall be fitted with a Vibroclock, the cost of which shall be included in the rates. Excessive non-productive time when the engine is idling will not be paid for. Where there is ambiguity between the flywheel horsepower and mass of the machine, the flywheel horsepower shall govern the measurement category. Where width and mass are specified, mass

shall govern the measurement category.

The Contractor's attention is drawn to the requirements of Clauses 6.5.3 and 6.5.4 of the General Conditions of Contract 2015 with regard to the submission of lists and statements of personnel, materials and construction equipment used for daywork.

The payment items under C1.2.8 in the Standard Specifications for Road and Bridge Works for South African Road Authorities (COTO), Draft Standard (DS), October 2020 will be applicable.

PSA1.2.3.18 Stakeholder liaison

Add the following to Clause A1.2.3.18:

(h) Project Liaison Committee

The process of implementing infrastructure projects will be undertaken by means of structured engagement between those responsible for the delivery of the project and the community.

A Project Liaison Committee (PLC) is a vital means of communication between the parties involved with the project. A PLC may be formed if the project is such that a specific community can be identified.

The PLC comprises representatives of the employer, the engineer and formal structures within the community. The contractor shall make use of these communication channels, and shall appoint from amongst his site personnel a responsible person to participate in the affairs of the PLC, and this representative shall also attend the monthly PLC meetings when so requested.

The PLC shall meet at least once every month until such time as it is of the opinion that it could fulfil its tasks by meeting less frequently.

The PLC deals with local labour on the project, and is tasked with:

- assisting with community liaison and the resolution of community disputes;
- devising fair and transparent procedures that will assist the contractor in the engagement of labour;
- advising on and monitoring labour issues; and
- Assisting in the resolution of labour disputes.

All labour recruitment, employment and associated risks shall remain the sole responsibility of the contractor.

A new pay item is included in Chapter 1.2 of the schedule of quantities relating to the payment of the PLC on a provisional sum basis. Payment under this item shall be made only for the period for which the duties of the PLC are required, and not necessarily for the full duration of the contract.

(i) Community Liaison Officer (CLO)

The contractor, after consultation with the Project Liaison Committee (PLC), shall appoint a competent local person as a Community Liaison Officer (CLO). The contractor shall appoint the CLO as part of his site personnel, and shall direct all his liaison efforts with the local community through the appointed CLO.

The period of employment and the remuneration of the CLO shall be determined jointly by the contractor, the engineer and the employer.

The CLO shall:

- i. represent the community and assist the contractor, the engineer and the employer with communication between them and the community;

- ii. work an 8-hour day with a total of 40 hours worked per week, and shall be present on site each day except when performing off-site community liaison activities;
- iii. communicate daily with the contractor on labour related issues such as numbers and skill;
- iv. assist in the identification and screening of local labourers from the community in accordance with the contractor's requirements;
- v. inform local labour of their conditions of employment, including their period of employment;
- vi. attend disciplinary proceedings involving local labour, and ensure that hearings are fair and reasonable;
- vii. attend all meetings at which the community and/or local labour are present or are required to be represented;
- viii. attend monthly site meetings to report on community and local labour matters;
- ix. keep a daily written record of interviews and community liaison;
- x. submit monthly returns regarding community liaison; and
- xi. Carry out all such other duties as agreed upon between all parties concerned.

A new pay item is included in Chapter 1.2 of the schedule of quantities relating to the payment of the CLO on a provisional sum basis. Payment under this item shall be made only for the period for which the duties of the CLO are required, and not necessarily for the full duration of the contract.

Add the following new Clause A1.2.3.24:

PSA1.2.3.24 Compliance with the Road Traffic Act

When a service necessitates vehicles or plant travelling or working on a public road, the following shall apply:

- The vehicles and plant shall be licensed in terms of the National Road Traffic Act 1996 (Act No. 93 of 1996) as amended.
- Every driver and operator of a vehicle or an item of plant shall be in possession of a valid permit in respect of the class of vehicle or item of plant he / she is driving or operating.

The Contractor shall provide, erect and maintain sufficient road signs, barricades, fencing and guarding as may be necessary or required by the Employer's Agent or by any act, regulation or statutory authority in order to minimise the danger and inconvenience caused to vehicle and pedestrian traffic. The Contractor by accepting this contract shall be deemed to have indemnified the Employer and the Employer's Agent against any claims, damages and / or costs that may arise in this regard.

Amend the following payment item.

PSC1.2 MEASUREMENT AND PAYMENT

Item	Unit
PSC1.2.5 SAFETY	
PSC1.2.5.1 Health and Safety Plan.....	Lump Sum
PSC1.2.5.2 Implementation of health and safety plan	
a)Fixed Obligation.....	Lump Sum
b)Time Related	Month

The unit of measurement for item C1.2.5.1 shall be the lump sum. The lump sum shall include full compensation for assessing the risks associated with the Works, reviewing and taking cognisance of the Employer's health and safety specifications and/or requirements, preparing the Contractor's health and safety plans for each of (Verge maintenance, Drains, Guardrails, Road signs, Bladding, Construction of concrete pavement sections, Gabions and Surfaced road patching) and for the submission of copies of the plans to the Engineer.

The unit of measurement for item C1.2.5.2 b) shall be the month, or part thereof for the duration of the approved contract period. Part of a month shall be calculated to two decimal places. The contract rate shall include full compensation for implementing the health and safety plan, including the provision of a dedicated, full time health and safety officer, carrying out all the required site health and safety training and briefings, staff medical evaluations, monitoring and administrating the health and safety plan and for supplying all transport, personal protection safety items, other health and safety equipment, safety notices and any other health and safety related items that are required on site. The contact rate shall also include the provision of a monthly health and safety compliance report to the Engineer.

Add the following new payment items.

PSC1.2.10 Community Participation

- (a) Cost for community Participation (PLC and CLO)..... Prime Cost Sum
- (b) Handling costs and profit in respect of sub-item PSC1.2.10 (a) abovepercentage (%)

Expenditure under this item shall be made in accordance with clause 6.6 of the General Conditions of Contract 2015.

The tendered percentage is a percentage of the amount of expenditure approved by the Employer’s Agent under sub-item PSC1.2.10 (a), and shall include full compensation for the handling costs of the Contractor and the profit in connection with the provision of a Community Liaison Officer.”

Item **Unit**

PSC1.2.11 Compensation for Surveyor

- (a) Provision of Survey as requested by the Engineer PC Sum
- (b) Handling costs and profit in respect of sub-item PSC1.2.11 (a) abovepercentage (%)
Not to exceed 10% of the value of sub item (a)

Expenditure under this item shall be made in accordance with clause 6.6 of the General Conditions of Contract 2015.

The tendered percentage is a percentage of the amount of expenditure approved by the Employer’s Agent under sub-item PSC1.2.11 (a), and shall include full compensation for the handling costs of the Contractor and the profit in connection with the provision of specialist services as requested by the engineer.

Item **Unit**

PSC1.2.12 Compensation for Geotechnical Consultant

- (a) Provision of Geotechnical Engineering Specialist as requested by the Engineer PC Sum
- (b) Handling costs and profit in respect of sub-item PSC1.2.12 (a) abovepercentage (%)
Not to exceed 10% of the value of sub item (a)

Expenditure under this item shall be made in accordance with clause 6.6 of the General Conditions of Contract 2015.

The tendered percentage is a percentage of the amount of expenditure approved by the Employer’s Agent under sub-item PSC1.2.12 (a), and shall include full compensation for the handling costs of the Contractor and the profit in connection with the provision of specialist services as requested by the engineer.

Item **Unit**

PSC1.2.13 Compensation for Environmental Consultant

- (a) Provision of Environmental Specialist as requested by the Engineer PC Sum
- (b) Handling costs and profit in respect of sub-item PSC1.2.13 (a) abovepercentage (%)
Not to exceed 10% of the value of sub item (a)

Expenditure under this item shall be made in accordance with clause 6.6 of the General Conditions of Contract 2015.

The tendered percentage is a percentage of the amount of expenditure approved by the Employer's Agent under sub-item PSC1.2.13 (a), and shall include full compensation for the handling costs of the Contractor and the profit in connection with the provision of specialist services as requested by the engineer.

Item **Unit**

PSC1.2.14 Compensation for Health and Safety Agent

- (a) Provision of a Health and Safety Agent as requested by the Engineer PC Sum
- (b) Handling costs and profit in respect of sub-item PSC1.2.14 (a) abovepercentage (%)
Not to exceed 10% of the value of sub item (a)

Expenditure under this item shall be made in accordance with clause 6.6 of the General Conditions of Contract 2015.

The tendered percentage is a percentage of the amount of expenditure approved by the Employer's Agent under sub-item PSC1.2.14(a), and shall include full compensation for the handling costs of the Contractor and the profit in connection with the provision of a SACPCMP registered Health and Safety agent as requested by the engineer.

Item **Unit**

PSC1.2.15 Adhoc Designs as conducted by the Engineer

- (a) Provision of Adhoc designs as conducted by a registered professional (PR Eng or PR Tech Eng) PC Sum
- (b) Handling costs and profit in respect of sub-item PSC1.2.15 (a) abovepercentage (%)
Not to exceed 10% of the value of sub item (a)

Expenditure under this item shall be made in accordance with clause 6.6 of the General Conditions of Contract 2015.

The tendered percentage is a percentage of the amount of expenditure approved by the Employer's Agent under sub-item PSC1.2.15 (a), and shall include full compensation for the handling costs of the Consultant and the profit in connection with the provision of an ECSA registered Engineer as requested by the Project engineer or Client.

CHAPTER 1.5 ACCOMMODATION OF TRAFFIC

PART C: MEASUREMENT AND PAYMENT

Amend the following payment item.

PSC1.5 MEASUREMENT AND PAYMENT

Item	Unit
PSC1.5.7.3 Flagmen	man-shift

The contract rate shall include full compensation for the provision of trained flagmen and for all wages, Employer contributions, accommodation, transport, Stop-Go signage, red warning flag or an amber LED strobe wand and safety clothing and other staff related costs incurred by the Contractor, including their recruitment and training costs.

Add the following new payment item.

Item	Unit
PSC1.5.13 Blading by road grader	
PSC1.5.13.1. Blading by road grader of <6m	
a) Machine Trimming: Normal Blading – 3%camber - without Watercart	kilometre (km)
b) Machine Trimming: Dry Road Blading using Watercart – 3% camber	kilometre (km)
PSC1.5.13.2 Blading by road grader of >6m	
a) Machine Trimming: Normal Blading – 3% camber - without Watercart	kilometre (km)
b) Machine Trimming: Dry Road Blading using Watercart – 3% camber	kilometre (km)

The tenderer is to assume that it will take 4 passes with a grader to achieve the desired road profile, a further 4 passes with the grader to spread the fines and a further 2 passes to achieve the required finish. The rate for Dry Road Blading shall include the utilisation of a Water sprinkler to thoroughly water the full width of gravel layer by making sufficient passes as required, ahead of the grader. The rate shall include for Travelling to and from the Contractor camp. The measurement will be the km of completed road. The rate shall further include for the removal and cleaning of any spillage of material into existing structures and catch pits.

CHAPTER 8.4 RUT AND/OR DEPRESSION CORRECTION

Amend the following payment item to include additional requirements.

Item	Unit
PSC8.4.1.2 Correction material	ton (t)

The contract rates shall include full compensation Saw Cutting and forming 2 No of 50 x 40mm keys both sides of the rut.

CHAPTER 8.8 PATCHING AND EDGE BREAK REPAIR

Add the following new payment item.

Item	Unit
C8.8/ PSC1.5.7.7 Traffic calming devices	meters

The contract rates shall include full compensation for the provision and construction of the traffic calming devices as specified. Signage for speed hump is paid separately under Section C11.6.

Item	Unit
PSC8.8.7.4. Temporary cold mix plug	
a) Patches less than 1m ²	square meter (m ²)
b) Patches greater than 1m ² but not exceeding 2m ²	square meter (m ²)

The tendered rate shall include full compensation for providing all the material, transport, work in restricted areas, machinery, equipment, labour, supervision, excavating and removing the existing premix surface and loose material to an overall depth of approximately 100mm, scarifying and removal of all loose material and dust by means of sweeping/brushing. Prepare the surface with 0.55l/m² of 60% anionic Bitumen emulsion tack coat to be verified with the engineer and backfilling the area with approved cold mix Asphalt with a maximum aggregate size of 10mm and in accordance with TRH 8, compacted to a density of 97 % Rice – design voids, to 5mm above the existing road surface level. All Potholes are required to be patched within 24 hours from the time that the pothole is reported to the contractor.

CHAPTER 11.3 GUIDE BLOCKS AND KILOMETRE MARKER

Add the following new payment item.

PSC11.3 MEASUREMENT AND PAYMENT

Item	Unit
PSC11.3.4 Repainting of Kilometer Post	Number (No)

The unit of measurement shall be the number of Kilometre posts painted.

The tendered rate shall include full compensation for all labour and material and painting, as may be necessary for completing the work in accordance with the details shown on the drawings (SD1003/B).

CHAPTER 11.8 LANDSCAPING AND PLANTING PLANTS

Amend the following payment item.

PSC11.8. MEASUREMENT AND PAYMENT

Item	Unit
PSC11.8.7 Mowing the grass	ha

The tendered rate shall include mowing/cutting Mowing/cutting the grass, shrubs, reeds, etc, to a height of 50mm above ground level, 3.0m from the edges of the road and to the medians where applicable, (Note: ha=10 000 m²).

It must also include full compensation for all plant, equipment and labour required for every cutting of the grass and collection and disposing of the grass cuttings to an approved dump site, i.e. payment will be made every time the grass has been cut on the instructions of the Engineer.

Add the following new chapter.

CHAPTER 15.1 CHEMICAL CONTROL OF UNDESIRABLE VEGETATION

PS PART A: SPECIFICATION

PSA15.1.1 SCOPE

This specification covers the chemical eradication of declared and undesirable vegetation as well as the chemical control of vegetation growth, through the application of herbicide.

PSA15.1.2 EXECUTION OF WORK

The Contractor's attention is drawn to the requirement that, prior to carrying out any spraying with herbicide, he/she, together with 3 assistants, shall be required to attend a 3- to 5-day accredited training workshop.

The registered Contractor shall be at the site of application at all times during spraying and shall ensure that no damage is caused to other plants inside or adjacent to the treated areas as a consequence of the application of herbicides.

Application shall not be carried out in high winds or wet weather.

The Contractor shall assess the number of different types of places where application of chemicals will be required and to make provision accordingly for the fluctuating chemical demand per section of road. The herbicide shall be strictly applied at the rate recommended by the manufacturer.

(j) Control of vegetation growth

Subject to approval by the Engineer beforehand, spraying shall be executed in the following designated areas:

- i. Shoulder weed spray shall involve the spraying of a 300 mm wide strip of herbicide, 100mm of which will be on the surfaced shoulder and 200 mm on the gravel shoulder;
- ii. Vegetation under guard-rails shall be controlled by spraying under the guard-rail to a minimum width of 500 mm;
- iii. Openings, cracks and joints between the road pavement and concrete, on joints and cracks of concrete drainage channels as well as between paving stones and concrete blocks, to a minimum width of 100 mm;
- iv. Up to a minimum distance of 300mm around the poles at kilometre markers, road signs and guard-rail posts;
- v. On block paved areas; and
- vi. Between the road and the road reserve fence or neighbouring fence or wall.

(k) The eradication of undesirable vegetation

The eradication of declared and undesirable vegetation shall take place in the road reserve over the whole length of the section of road involved and may include localised patches of noxious weeds, invader plants and other undesired vegetation.

The Contractor shall ensure that no damage whatsoever is caused to any plants inside or adjacent to the areas treated because of the application of the herbicides, either during or after application. This also includes areas outside the road reserve.

Below is a list of preferred chemicals to be used in the various applications.

Verge Application	
Product	Active ingredients:
Tumbleweed (L4781)	Glyphosate 240g/L
Invade (L10093)	Imazapyr 250g/L

Outpace Flo (L4760)	Simazine 250g/L + Terbutylazine 250g/L
Booster AS (L6182)	Ammonium Sulphate 500g/L
<u>Noxious weed Control</u>	
Frixon (L8399)	Fluroxypyr 200g/L
Picloram (L8299)	Picloram 240g/L
Viroaxe (L6663)	Triclopyr 480g/L
Ambition (L7678)	Metsulfuron - Methyl 600g/L
Booster Oil (L6148)	Vegetable Oil 851g/L
<u>Cut stump Treatment</u>	
Invade (L10093)	Imazapyr 250g/L
Booster Oil (L6148)	Vegetable Oil 851g/L
Dye (Stump marker)	Pigment dye

Prior to commencement with application of any herbicide, a registration document from the Department of Agriculture must be provided to the Employers Agent for each chemical to be used. The Employers Agent will approve the use of the specific chemical prior to commencement.

PSA15.1.3 ACCEPTANCE CRITERIA

Eradication of undesired vegetation shall be carried out as specified and to the satisfaction of the Engineer. The herbicide shall be applied at the correct rate to prevent re-growth and the application confined to the undesired vegetation.

Areas shall be left neat and tidy and all vegetation cuttings removed unless otherwise instructed.

PSA15.1.4 CONSTRUCTION EQUIPMENT

Vegetation shall be eradicated using knapsacks or portable weed-spray machines.

It is important that the equipment be in good working condition. The equipment shall distribute the herbicide evenly without spilling. The nozzle shall be able to move close to the ground in order to prevent mist spray blowing away and killing plants which have to be maintained. The equipment shall also be safe for the workers as well as for the travelling public. The Contractor shall ensure that all persons dealing with herbicides are supplied with hats, gloves, boots, goggles, face masks and safety vests and that they always wear them whilst working.

PS PART B: MEASUREMENT AND PAYMENT

Add the following payment items:

Item	Unit
PSC15.1.1: Chemical Control of undesirable vegetation	
a) Shoulder Weed Spray: 300mm wide	meter (m)
b) Under Guardrails: 500mm wide	meter (m)
c) Openings, crack and joints: 100mm wide	meter (m)
d) Around poles, Kilometre markers, road signs, guardrail posts. The area around the signs and kilometre posts are required to be a 2m radius.	number (No)
e) Blocked paved and other paved areas	square meter (m ²)
f) Along the Road Reserve	

- i. Isolated Areas square meter (m²)
- ii. Dense areas (areas more than 20% infested) hectare (ha) the unit of measurement for sub-items PSC15.1.1 (a) to (c) shall be the metre of control of weeds to the specified width.

The unit of measurement for sub-items PSC15.1.1 (d) shall be the number of poles, road markers, road signs and guard-rail posts sprayed around.

The unit of measurement for sub-items PSC15.1.1 (e) and (f)(i) shall be the square metre of control of vegetation and eradication of weeds.

The unit of measurement for sub-item PSC15.1.1 (f) (ii) shall be the hectare of control of vegetation and eradication of weeds. The areas will be measured by dense hectare (the percentage of infestation per hectare). For payment, the rate per hectare will be that multiplied by the percentage infestation.

The tendered rates shall include full compensation for all labour, equipment and minor material (herbicide shall be supplied by the Employer) required for control of vegetation and eradication of weeds in accordance with the manufacturer's specifications and inclusive of any costs arising from restricted working conditions due to the nature of the site or traffic flow.

Payment shall be made as follows:

- (a) 60% shall be payable when visible results are obtained
- (b) The remaining 40% shall be payable when at least 90% of the treated vegetation has been controlled in the opinion of the Engineer

C3.3: PARTICULAR SPECIFICATIONS

In addition to the Standard Specifications and the Project Specifications, the following Particular Specifications shall apply to this contract and are bound in hereafter:

PART C: ENVIRONMENTAL MANAGEMENT SPECIFICATION	C89
PART D: OHSA 1993 HEALTH AND SAFETY SPECIFICATION	C95
PART E: EXPANDED PUBLIC WORKS PROGRAMME.....	C104
PART F: SMALL CONTRACTOR DEVELOPMENT	C139
PART G: CONTRACT SKILLS DEVELOPMENT GOAL.....	C184

3.3 PARTICULAR SPECIFICATIONS

PART C: ENVIRONMENTAL MANAGEMENT SPECIFICATION

PART C: ENVIRONMENTAL MANAGEMENT SPECIFICATION

C1. SCOPE

The Employer recognises environmental management as a key component of road infrastructure development and as part of its environmental policy has developed this environmental management specification as a tool for continual improvement in environmental performance.

This environmental management specification prescribes the methods by which proper environmental controls are to be implemented by the Contractor. The duration over which the Contractor's controls shall be in place cover the construction period of the project as well as the limited time after contract completion defined by the General Conditions of Contract 2015 as the Defects Notification Period (maintenance period).

C2. ENVIRONMENTAL MANAGEMENT PLAN

In order to ensure that the construction work is carried out in an environmentally sensitive manner, strict compliance with the Environmental Management Plan (EMP) guidelines is required. The purpose of the EMP is to:

- Encourage good management practices through planning and commitment to environmental issues,
- Provide rational and practical environmental guidelines to:
 - (i) Minimise disturbance of the natural environment,
 - (ii) Prevent pollution of land, air and water,
 - (iii) Prevent soil erosion and facilitate re-vegetation.
- Adopt the best practicable means available to prevent or minimise adverse environmental impact,
- Develop waste management practices based on prevention, minimisation, recycling, treatment or disposal of wastes,
- Train employees and contractors with regard to environmental obligations.

C3. ADMINISTRATION OF ENVIRONMENTAL OBLIGATIONS

The Contractor is responsible for the implementation of this EMP to ensure sound environmental management during the construction phase of a project.

The Contractor shall receive and implement any instruction issued by the Employer's Agent relating to compliance with the EMP including the removal of personnel or equipment.

Compliance with the provisions contained herein or any condition imposed by the environmental approvals, shall become the responsibility of the Contractor through an approved Environmental Officer (EO). The Contractor shall nominate a person from among his site personnel to fulfil this function and submit to the Employer's Agent for his approval the curriculum vitae of the proposed EO. This request for approval shall be given, in writing, at least fourteen days before the commencement of any construction activity clearly setting out reasons for the nomination, and with sufficient detail to enable the Employer's Agent to make a decision.

Once a nominated representative of the Contractor has been approved as the EO, the EO shall be the responsible person for ensuring that the provisions of this EMP are complied with for the duration of the contract. The EO shall submit monthly written reports of compliance with the EMP to the Employer's Agent.

In addition to the compliance duties relating to this EMP, the EO shall also provide full cooperation whenever the Contractor is subjected to regular environmental audits.

C4. TRAINING AND INDUCTION OF EMPLOYEES

The Contractor has a responsibility to ensure that all those people involved in the project are aware of and familiar with the environmental requirements for the project (this includes subcontractors and local labour). The EMP shall be part of the terms of reference for all contractors, subcontractors and suppliers.

C5. COMPLAINTS REGISTER AND ENVIRONMENTAL INCIDENT BOOK

Any complaints received by the project team from the public will be recorded. The complaint should be brought to the attention of the Construction Manager, who will respond.

The following information must be recorded:

- Time, date and nature of the complaint,
- Type of communication (telephone, letter or email),
- Name, contact address and telephone number of the complainant,
- Response and investigation undertaken, and
- Actions taken and by whom.

All complaints received will be investigated and a response given to the complainant within 14 days.

All environmental incidents occurring on the site will be recorded. The following information will be provided:

- Time, date, location and nature of the incident, and
- Actions taken and by whom.

C6. SITE CLEANLINESS AND NEATNESS

- Location of a construction camp is to be approved by the Employer's Agent and is to be restored to its previous condition after completion of construction.
- The construction camp should preferably be fenced with a 1,8m Bonnox fence or similar approved.
- All materials, equipment, plant and vehicles must be stored within the construction camp.
- A dedicated area must be made available for construction staff to change and store their personal belongings.

C7. ACCESS

- Access to existing roads, schools, buildings, shops and residential properties must not be impeded during construction.
- Access roads utilised by the Contractor must be maintained in good condition.

C8. BORROW PITS

C9. DUST CONTROL / AIR QUALITY

- Mining authorisations (permits) for borrow pits must be obtained from the Department of Mineral Resources (DMR) in consultation with the Department of Water and Sanitation (DWS).
- Spoil dumps resulting from borrow pits must not interfere with any natural surface drainage.
- Borrow pits must be rehabilitated after use in accordance with the requirements of DMR and DWS.
- Dust suppression measures must be implemented during construction by ensuring that all surfaces prone to dust generation are kept damp (e.g. use of water tanker).
- Ensure that vehicles and equipment are in good working condition and that emissions are not excessive.
- Special care must be taken in areas where the route passes close to schools and residential areas.
- The speed of construction vehicles must be reduced.

C10. FAUNA

- Contractors' and subcontractors' staff and workers may not chase, catch or kill animals encountered during construction.

C11. FIRE PREVENTION AND CONTROL

- Smoking is prohibited in the vicinity of flammable substances.
- The Contractor must ensure that fire-fighting equipment is available on site, particularly where flammable substances are being stored or used, and that construction staff are aware of where it is kept and how it is operated.
- Fires started for comfort (warmth) are prohibited, due to the risk of veld fires and risk to adjacent property owners' lands.

C12. GRAVE SITES

- Grave sites in close proximity to the road must not be disturbed during construction.

C13. MATERIALS HANDLING AND SPILLS MANAGEMENT

- Any hazardous materials to be used during construction (e.g. lime, fuel and paint) are to be stored in a designated area at the campsite.
- The storage containers/facilities (including any diesel or petrol tanks) must be placed on an impermeable surface and surrounded by a bund wall, in order to ensure that accidental spillage does not pollute the environment.
- Workers must at all times be made aware of the health and safety risks associated with any hazardous substances used (e.g. smoking near fuel tanks), and must be provided with appropriate protective clothing/equipment in case of spillages or accidents.
- Ensure all staff and contractors undergo relevant training in the maintenance of equipment to prevent the accidental discharge or spill of fuel, oil, lubricants and other chemicals.
- Any spill of potentially hazardous materials must be cleaned up immediately (potentially hazardous materials on site include paint, oil, grease, fuel and turpentine).
- The area of contaminated soil or spill must be deposited into the hazardous waste container(s).
- The Contractor should keep Peat Sorb or a similar absorbent on site to clean up any spills. The absorbent must be stored in a designated area and be available for inspection.
- All spills are to be recorded in the environmental incident book.

C14. NOISE

- Noise generating activities must be restricted to between 07:00 and 17:00 Monday to Friday, unless otherwise approved by the appropriate competent person in consultation with adjacent landowners/affected persons.
- All equipment, vehicles and machinery must be in good working condition and be equipped with sound mufflers if necessary.
- Construction staff must be trained and made aware of not creating unnecessary noise such as hooting and shouting.

C15. POLLUTION CONTROL

- Soil and water pollution through usage of fuel, oil, paint, bitumen or other hazardous substances must be avoided.
- All construction vehicles are to be maintained in good working order so as to prevent soil or water pollution from oil, fuel or other leaks, and to reduce noise pollution.

C16. RIVERS AND STREAMS

- During construction of bridge structures, there must be no obstruction of the water flow of rivers and streams.
- Excavated material must not be stockpiled on or near riverbanks, in order to prevent sedimentation occurring.
- Erosion control measures must be employed both during and after construction.
- No impediments to natural surface water flow, other than approved erosion control measures, must occur.

C17. SAFETY

- Safety measures, such as detour signs, must be implemented during construction to ensure the safety of workers, pedestrians and drivers/passengers in vehicles in the vicinity of construction work.
- Special care must be taken in the vicinity of schools to ensure the safety of children wishing to cross the road under construction.
- The relevant signage (e.g. speed control signs) must be erected alongside the road during the operation phase in order to control traffic.
- Accommodation must be made for pedestrian pathways alongside the road during the construction and operation phases.

C18. SOIL MANAGEMENT

- Storm water drainage pipes must be installed alongside the road in all areas susceptible to soil erosion.
- Erosion should be minimised by the construction of meadow drains and the planting of indigenous vegetation on the side slopes and drains to reduce flow velocity of storm water.
- Spoil from cuts may be used in existing erosion gullies.
- Stone pitching and gabions should be constructed at pipe culvert outlets.
- Accidental spills of contaminants onto the ground e.g. oil, concrete, fuel and chemicals should be removed together with the contaminated soil.
- If necessary, an absorbent such as Peat Sorb should be used to aid in cleaning up the spill. The contaminated soil should be disposed of in an appropriate container, depending on its classification.
- Servicing and refuelling of vehicles must only be carried out at the construction camp.

C19. WORKER CONDUCT

Code of Conduct for Construction Personnel:

- Do not leave the construction site untidy and strewn with rubbish which will attract animal pests.
- Do not set fires.
- Do not cause any unnecessary, disturbing noise at the construction camp/site or at any designated worker collection/drop off points.
- Do not drive a construction-related vehicle under the influence of alcohol.
- Do not exceed the national speed limits on public roads or exceed the recommended speed limits on the site.
- Do not drive a vehicle which is generating excessive noise or gaseous pollution (noisy vehicles must be reported and repaired as soon as possible).
- Do not litter along the roadsides, including both the public and private roads.
- Do not pollute any water bodies (whether flowing or not).
- No member of the construction team is allowed to enter the areas outside the construction site.

C20. TRAFFIC DISTURBANCES AND DIVERSIONS

- Any traffic diversions must be undertaken with the approval of all relevant authorities and in accordance with all relevant legislation.
- Wherever possible, traffic diversion must only take place on existing disturbed areas and remain within the existing road reserve.
- Traffic diversion routes must be rehabilitated after use.

C21. VEGETATION

- Only vegetation falling directly on the route must be removed where necessary.
- Alien vegetation within the road reserve must be eradicated, and management measures must be implemented for future control of these species.
- Vegetation that has been removed from large areas (e.g. on traffic diversion routes) during construction must be replaced with indigenous vegetation after construction has been completed.

C22. WASTE MANAGEMENT

- All general, non-hazardous waste must be placed in a skip container and disposed of at a registered waste disposal site.
- The Contractor is to ensure that the portable toilet facilities at the campsite are properly maintained and in working order.
- No disposal, or leakage, of sewage must occur on or near the site.
- All hazardous waste (e.g. oil, paint, empty lime bags, and contaminated wash water) must be stored in leakproof containers and disposed of at a registered hazardous waste disposal site.
- The contents of waste storage containers must, under no circumstances, be emptied to the surrounding area. In general, littering, discarding or burying of any materials is not allowed on site or along the route.
- Adequate waste receptacles must be available at strategic points around the construction camp and site for all domestic refuse and to minimise the occurrence of littering.
- Concrete rubble must be collected and disposed of as directed by the Employer's Agent.
- Each working area must be cleared of litter and building waste (e.g. rubble, wood and concrete packets) on completion of the day's work.
- Any spill around the container(s) should be treated as per clause C13 and C18.

C23. MEASUREMENT AND PAYMENT

The contractor shall make provision in the various rates and prices for all costs related to the environmental management specification and measures required in terms of legislation. Provision is made in item B13.02 of the Bill of Quantities for the contractor's general obligations, risks and liabilities in accordance with the environmental management specification.

C3.3 PARTICULAR SPECIFICATIONS

PART D: OHSA 1993 HEALTH AND SAFETY SPECIFICATION

PART D: OHS 1993 HEALTH AND SAFETY SPECIFICATION

D1. SCOPE

This part covers the health and safety requirements to be met by the Contractor to ensure a continued safe and healthy working environment for all employees, subcontractors, the Employer, the Employer's Agent, inspectors and all other persons entering the site of works.

This specification shall be read in conjunction with the Occupational Health and Safety Act, 1993 (Act No 85 of 1993 and amendment Act No 181 of 1993) and the corresponding Construction Regulations 2014, and all other safety codes and specifications referred to in the said Act and Construction Regulations.

In terms of the OHS 1993 Agreement in Section C1.4 of the Contract document, the status of the Contractor as mandatory to the Employer (client) is that of an employer in his own right, responsible for compliance with all provisions of OHS 1993 and the Construction Regulations 2014.

This specification and the Contractor's own Health and Safety Plan as well as the Construction Regulations 2014, shall be displayed on site or made available for inspection by inspectors, the Employer, the Employer's Agent, the Construction Health and Safety Agent, subcontractors, employees, representatives of trade unions and any other persons entering the site of works.

D2. DEFINITIONS

For the purpose of this contract the following shall apply:

D2.1 "**Construction Health and Safety Agent**" (CHSA) means any competent person who acts as a representative for the Employer in managing health and safety on a construction project for the Employer and who has satisfied the registration criteria of the SACPCMP to perform the required functions.

D2.2 "**Contractor**" where used in the contract documents and in this specification, means the Contractor as defined in the General Conditions of Contract 2015, and it shall have the exact same meaning as "**principal contractor**" as defined in the Construction Regulations 2014. "**Contractor**" and "**principal contractor**" are therefore interchangeable and shall be read in the context of the relevant document.

In this specification the terms "**principal contractor**" and "**contractor**" are replaced with "**Contractor**" and "**subcontractor**" respectively.

For the purpose of this contract the Contractor will, in terms of OHS 1993, be the mandatory, without derogating from his status as an employer in his own right.

D2.3 "**Employer**" where used in the contract documents and in this specification, means the Employer as defined in the General Conditions of Contract 2015 and it shall have the exact same meaning as "**client**" as defined in the Construction Regulations 2014. "**Employer**" and "**client**" are therefore interchangeable and shall be read in the context of the relevant document.

D2.4 "**Employer's Agent**" where used in this specification, means the Employer's Agent as defined in the General Conditions of Contract 2015.

D3. EMPLOYER'S BASELINE RISK ASSESSMENT

D3. EMPLOYER'S BASELINE RISK ASSESSMENT

D3.1 Risk information

The information presented in this clause is based on the Employer's baseline risk assessment prepared specifically for this contract.

This information describes the type of work required in terms of this contract that will be accompanied by dangers, hazards and risks which the Contractor shall be required to identify, analyse, manage, monitor and review in terms of the Health and Safety Plan and risk assessments.

This information is neither prescriptive nor exhaustive, and is provided as a guideline to Tenderers in preparing their tender submissions, and to the successful Contractor as a basis for the preparation of the site-

specific risk assessments to be performed by the Contractor in terms of Construction Regulation 9.

Tenderers shall make their own assessment of the dangers, hazards and risks that can be expected during the course of this contract, which may include dangers, hazards and risks not identified in the baseline risk assessment, including those that may arise from specific methods of construction employed by the Contractor, and shall make due allowance in their tendered rates and prices for all costs related to complying with the provisions of the Act and Construction Regulations.

This information is given in good faith for the guidance of Tenderers, and no additional payment shall be made as a result of any inaccuracies, discrepancies or omissions contained therein.

D3.2 Baseline risk assessment

The following is a list of risks identified which forms the Baseline Risk Assessment for the project prepared by the Employer in terms of Construction Regulation 5(1)(a).

D3.3 Guidelines for construction and maintenance projects under Covid-19 Lockdown

The Employer has prepared guidelines which set out the key principles and minimum requirements that define responsible, healthy and safe operations for road construction operations under COVID-19 Lockdown conditions, for the Contractor to comply with. In addition, the Contractor shall comply with any new COVID-19 Regulations issued by Government.

The guidelines have been included as Annexure A at the end of this Project Document.

D4. APPLICATION FOR CONSTRUCTION WORK PERMIT

Where the contract meets the requirements of Construction Regulation 3, the Employer must at least 30 days before commencement of the work and in accordance with the requirements of Construction Regulation 3, apply to the Provincial Director of the Department of Labour in writing for a construction work permit to perform construction work. The Employer's application must be done in a form similar to Annexure 1 of the Construction Regulations, and submitted with the required documentation, some of which the Contractor shall provide as stated in the Contract Data.

A copy of the construction work permit must be kept on site in the occupational health and safety file, available for inspection by inspectors, the Employer, the Employer's Agent, the Construction Health and Safety Agent, subcontractors, employees, representative trade unions and any other persons on the site. The Provincial Director will assign a site-specific number for each construction site, which must be conspicuously displayed at the main entrance to the site.

D5. NOTIFICATION OF CONSTRUCTION WORK

Where the contract meets the requirements of Construction Regulation 4, the Contractor shall, before commencement of the work and in accordance with the requirements of Construction Regulation 4, notify the Provincial Director of the Department of Labour of the intention to carry out the construction work, using the pro forma form included as Annexure 2 to this Health and Safety Specification.

A copy of the notification form must be kept on site, available for inspection by inspectors, the Employer, the Employer's Agent, the Construction Health and Safety Agent, subcontractors, employees, representative trade unions and any other persons on the site. A copy of the notification form shall also be kept on the health and safety file, and a further copy shall be forwarded to the Employer for his records.

D6. HEALTH AND SAFETY PLAN

Before commencement of any construction work, the Contractor shall prepare a project specific Health and Safety Plan complying with the requirements of Construction Regulation 7(1)(a) and this Health and Safety Specification.

The Health and Safety Plan must include a risk assessment performed and recorded in writing by a competent

person as required in terms of Construction Regulation 9. The risk assessment shall identify and evaluate the risks and hazards that may be expected during the execution of the work under the contract, and it shall include a documented plan and applicable safe work procedures to mitigate, reduce or control the risks and hazards identified.

The Health and Safety Plan shall be available on site for inspection by inspectors, the Employer, the Employer's Agent, subcontractors, employees, representative trade unions, and health and safety representatives and committee members, and must be monitored and reviewed periodically by the Contractor.

D7. APPOINTMENT OF EMPLOYEES AND SUBCONTRACTORS

D7.1 Appointments

The Contractor shall appoint in writing all employees.

The Contractor shall appoint in writing all subcontractors, and such appointments shall be in compliance with the requirements of Construction Regulation 7.

D7.2 Health and safety induction training

No person shall be allowed or permitted to enter the site of the works unless such person has undergone health and safety induction training pertaining to the hazards prevalent on the site.

The Contractor shall ensure that all employees under his control, including subcontractors and their employees, undergo health and safety induction training by a competent person before commencement of construction work in compliance with Construction Regulations 7(5) and 9(3) and (4).

The Contractor shall ensure that all visitors to the construction site undergo health and safety induction and are provided with the necessary personal protective equipment in compliance with Construction Regulation 7(6).

D7.3 Medical certificate of fitness

The Contractor shall ensure that every employee, including subcontractors and their employees, has a valid medical certificate of fitness issued in compliance with Construction Regulation 7(1)(g) or 7(8) as applicable.

D8. APPOINTMENT OF SAFETY PERSONNEL

D8.1 Construction manager

Refer to Construction Regulation 8(1), (2), (3) and (4).

The Contractor shall appoint a full-time **Construction Manager** with the duty of managing all the construction work on the site, including the duty of ensuring occupational health and safety compliance.

The Contractor may also have to appoint one or more **assistant construction managers** to assist the Construction Manager where justified by the scope and complexity of the works.

D8.2 Construction health and safety officer

Refer to Construction Regulation 8(5) and (6).

Taking into consideration the size of the project and the dangers, hazards or risks that can be expected, the Contractor shall appoint in writing a full-time or part-time **construction health and safety officer** to assist in the control of all health and safety related aspects on the site. The construction health and safety officer shall be registered as required by the Chief Inspector of the Department of Labour and shall have the necessary competencies and resources to assist the Contractor.

D8.3 Construction supervisor

Refer to Construction Regulation 8(7), (8), (9) and (10).

The Contractor shall appoint a **construction supervisor** responsible for construction activities and ensuring occupational health and safety compliance on the construction site.

The Contractor may also have to appoint one or more competent employees to assist the construction supervisor where justified by the scope and complexity of the works.

D8.4 Health and safety representatives

In terms of Sections 17 and 18 of the Act (OHSA 1993) the Contractor, being the employer in terms of the Act for the execution of the contract, shall appoint a **health and safety representative** whenever he has more than 20 employees in his employment on the site of the works. The health and safety representative must be selected from employees who are employed in a full-time capacity at a specific workplace.

The number of health and safety representatives for a workplace shall be at least one for every 50 employees.

The function of health and safety representative(s) will be to review the effectiveness of health and safety measures, to identify potential hazards and major incidents, to examine causes of incidents (in collaboration with his employer, the Contractor), to investigate complaints by employees relating to health and safety at work, to make representations to the employer (Contractor) or inspector on general matters affecting the health and safety of employees, to inspect the workplace, plant, machinery, etc. on a regular basis, to participate in consultations with inspectors and to attend meetings of the health and safety committee.

D8.5 Health and safety committee

In terms of Section 19 of the Act (OHSA 1993), the Contractor (as employer) shall establish one or more **health and safety committees** where there are two or more health and safety representatives at a workplace. The persons selected by the Contractor to serve on the committee shall be designated in writing.

The function of the health and safety committee shall be to hold meetings at regular intervals but at least once every three months, to review the health and safety measures on the contract, to discuss incidents related to health and safety with the Contractor and the inspector, to make recommendations regarding health and safety to the Contractor and to keep record of recommendations and reports made by the committee.

D8.6 Competent persons

The Contractor shall appoint in writing designated competent employees and/or other competent persons as required by the Act and Regulations. Such appointments shall be in accordance with the relevant applicable sections of the Act and Regulations as determined by the requirements of the contract.

A competent person may be appointed for more than one part of the construction work with the understanding that the person must be suitably qualified and able to supervise at the same time the construction work in all the work situations for which he has been appointed.

The appointment of competent persons to supervise parts of the construction work does not relieve the Contractor from any of his responsibilities for compliance with **all** requirements of the Construction Regulations.

D9. RECORDS AND REGISTERS

The Contractor shall keep records and registers related to health and safety on site as required by the relevant applicable sections of the Act and Regulations as determined by the requirements of the contract. Such records and registers shall be available for periodic inspection by inspectors, the Employer, the Employer's Agent, the Construction Health and Safety Agent, subcontractors, employees and representatives of trade unions.

D10. CONTRACTOR'S RESPONSIBILITIES

For this contract the Contractor will be the mandatary of the Employer (Client), as defined in the Act (OHSA

1993), which means that the Contractor has the status of employer in his own right in respect of the contract. The Contractor is therefore responsible for all the duties and obligations of an employer as set out in the Act (OHSA 1993) and the Construction Regulations 2014.

Before commencement of work under the contract, the Contractor shall enter into an agreement with the Employer (Client) in terms of C1.4 'Agreement in terms of Section 37(2) of the Occupational Health and Safety Act No. 85 of 1993', to confirm his status as mandatary (employer) for the contract under consideration.

The Contractor is advised in his own interest to make a careful study of the Act and the Construction Regulations, as ignorance of the Act and the Regulations will not be accepted in any proceedings related to non-conformance to the Act and the Regulations.

D11. MEASUREMENT AND PAYMENT

It is a condition of this contract that contractors who submit tenders for this contract shall make provision in their various tendered rates and prices for all costs related to the health and safety measures required in terms of the Act and Regulations during the construction process.

(a) Health and safety plan

The Contractor shall assess the risks associated with the Works when preparing the health and safety plan. In addition, the Contractor shall implement the health and safety plan, including the provision of a dedicated, full time health and safety officer, carrying out all the required site health and safety training and briefings, staff medical evaluations, monitoring and administering the health and safety plan and for supplying all transport, personal protection safety items, other health and safety equipment, safety notices and any other health and safety related items that are required on site. Provision is made for the costs of preparing and implementing the health and safety plan in item B13.03 of the Bill of Quantities.

(b) Safety appointments

No separate additional payment will be made to cover the costs related to persons appointed as required in terms of the Act and Regulations to fulfil the various health and safety functions. Such persons include the Construction Manager, any assistant construction managers, the construction health and safety officer, the construction supervisor, any assistant construction supervisors, health and safety representatives, health and safety committee members and competent persons, all as referred to in subclauses E8.1 to E8.6 above. The Contractor shall therefore make provision in the various tendered rates and prices for all costs related to such persons, and for which no separate additional payment will be made except to the extent provided in item B13.03 of the Bill of Quantities.

(c) Records and registers

The keeping of records and registers related to health and safety on site as described in clause E9 above shall be regarded as a normal duty of the Contractor for which payment shall be deemed to be included in the Contractor's various tendered rates and prices, and for which no separate additional payment will be made except to the extent provided in item B13.03 of the Bill of Quantities.

(d) Medical certificates

No separate additional payment will be made to cover the costs related to obtaining the medical certificates of fitness required for every employee, including subcontractors and their employees, issued in compliance with Construction Regulation 7(1)(g) or 7(8) as applicable. The Contractor shall therefore make provision in the various tendered rates and prices for all costs related to such medical certificates, and for which no separate additional payment will be made except to the extent provided in item B13.03 of the Bill of Quantities.

ANNEXURE 2

**OCCUPATIONAL HEALTH AND SAFETY ACT, 1993
(Regulation 4 of the Construction Regulations, 2014)**

NOTIFICATION OF CONSTRUCTION WORK

1. (a) Name and postal address of principal contractor:

.....
.....

(b) Name and telephone number of principal contractor's contact person:

.....

2. Principal contractor's compensation registration number:

3. (a) Name and postal address of client:

.....
.....

(b) Name and telephone number of client's contact person or agent:

.....

4. (a) Name and postal address of designer(s) for the project:

.....
.....

(b) Name and telephone number of designer's(s') contact person(s):

.....
.....

5. Name and telephone number of principal contractor's construction manager on site appointed in terms of regulation 8(1):

.....

6. Name(s) of principal contractor's assistant construction manager(s) on site appointed in terms of regulation 8(2):

ANNEXURE 2 - Continued

7. Exact physical address of the construction site or site office:

8. Nature of the construction work:

.....
.....

9. Expected commencement date:

10. Expected completion date:

.....

11. Estimated maximum number of persons on the construction site:

Total: Male: Female:

.....

12. Planned number of contractors on the construction site accountable to principal contractor:

.....

13. Name(s) of contractors already selected:

.....

.....

.....

.....
Principal Contractor **Date**

.....
Client's Agent (where applicable) **Date**

.....
Client **Date**

- THIS DOCUMENT IS TO BE FORWARDED TO THE OFFICE OF THE DEPARTMENT OF LABOUR **PRIOR TO COMMENCEMENT** OF WORK ON SITE.

C3.3 PARTICULAR SPECIFICATIONS

PART E: EXPANDED PUBLIC WORKS PROGRAMME

PART E: EXPANDED PUBLIC WORKS PROGRAMME

E1. SCOPE

This part provides the specifications with regard to the following:

- (a) The Expanded Public Works Programme (EPWP); and
- (b) The National Youth Service (NYS) programme, which is a government programme implemented by the National Department of Public Works forming part of the Expanded Public Works Programme (EPWP).

The Contractor shall be required to participate in job creation (employment of local labour) by executing various portions of the Works using local labour (unskilled or semi-skilled), recruited from the local community, who are South African Citizens or foreigners in possession of a work visa issued by the Department of Home Affairs (only one such foreigner may be employed on any project). Such local labour shall be the targeted participants in the EPWP and NYS programmes.

Furthermore, in order to avoid duplication of training facilities, the provision of training facilities for all structured training, including for the structured training described in Part F: Small Contractor Development (in those instances where Part F is included in the contract), shall be measured and paid for in terms of the pay items provided in this Part E.

E2. EXPANDED PUBLIC WORKS PROGRAMME (EPWP)

E2.1 Labour-enhanced construction, supervision and management for the Expanded Public Works Programme (EPWP)

The Expanded Public Works Programme (EPWP) is a multi-sectoral government initiative to create jobs. In the case of the infrastructure sector, existing government expenditure is realigned using Labour-Intensive technologies to create job opportunities. This involves the use of both labour and construction equipment, where labour is preferred and construction equipment is used appropriately.

All work undertaken in terms of the Expanded Public Works Programme (EPWP) shall be implemented using Labour-enhanced construction methods to the extent economically feasible, in accordance with the "Guidelines for the Implementation of Labour-enhanced Infrastructure Projects under the Expanded Public Works Programme (EPWP) Third Edition 2015".

The aforementioned guidelines can be downloaded from the EPWP website of the Department of Public Works (<http://www.epwp.gov.za/>).

Items scheduled for Labour-Intensive construction are marked with the letters "LI" in the bill of quantities in the manner described in C2.1 Pricing Assumptions.

Contractors shall note that they shall employ in Labour-enhanced works only the following supervisory and management staff that have completed the required Skills Programme in terms of Appendix C of the aforementioned guidelines:

- (a) Foremen / Supervisors at NQF level 4 "National Certificate: Supervision of Civil Engineering Construction Processes";
- (b) Site Agent / Construction Manager at NQF level 5 "Manage Labour-Enhanced Construction Processes" or equivalent Quality Council for Trades and Occupations (QCTO) qualifications at NQF level 5 or 7.

In addition to their normal supervisory and management functions, the aforementioned supervisory and management staff shall also be responsible for setting the workers' daily tasks in accordance with labour-enhanced construction principles, and for ensuring that the EPWP job creation reporting data is accurately recorded on a daily basis and compiled and submitted to the Employer each month in accordance with clause E4 of this Part E.

E2.2 Labour laws applicable to the Expanded Public Works Programme (EPWP)

The work to be undertaken on this contract by unskilled or semi-skilled workers under the Expanded Public Works Programme (EPWP) shall be implemented in accordance with:

- (a) the Code of Good Practice for Employment and Conditions of Work for Expanded Public Works Programmes (EPWP), issued in terms of the Basic Conditions of Employment Act of 1997 by the Minister of Labour in Government Notice No. 129 of 18 February 2011 (Government Gazette No. 34032 of 18 February 2011); and
- (b) Ministerial Determination 4: Expanded Public Works Programmes, issued in terms of the Basic Conditions of Employment Act of 1997 by the Minister of Labour in Government Notice No. R347 of 4 May 2012.

The aforementioned Government Notice No. R347 contains the standard terms and conditions for workers employed in elementary occupations on an Expanded Public Works Programme (EPWP). These terms and conditions do not apply to persons employed in the supervision and management of an Expanded Public Works Programme (EPWP).

The above documents can be downloaded from the EPWP website of the Department of Public Works (<http://www.epwp.gov.za/>).

E2.3 Persons to be employed under the Expanded Public Works Programme (EPWP)

All local labour required for the execution of labour-enhanced works shall be engaged strictly in accordance with prevailing legislation.

The Contractor shall, through the Project Liaison Committee (PLC) and with the assistance of the Community Liaison Officer (CLO), inform the local community of the Labour-enhanced works proposed and the employment opportunities thereby presented.

The Contractor shall determine the minimum education level / skills required to undertake the works specified. In consultation with the PLC and the War Room convener for each relevant ward, selection of the local labour shall be made from households on the Operation Sukuma Sakhe (OSS) database profiled through the War Room for each ward. The list obtained from the OSS database must be accompanied by a letter from the War Room convener confirming that all the information provided was sourced from the War Room and that all listed incumbents reside within the relevant ward. The Contractor must maintain records of household profiles as part of the portfolio of evidence for selection. Selection shall be based on the minimum education level / skills required and the most-needy households, as determined by the household profiling. Preference shall be given for at least one person from each household in the community to be employed before further persons are considered for selection.

The Contractor shall endeavor to ensure that the number of temporary jobs using local labour (unskilled or semi-skilled), recruited from the local community, who are South African Citizens or foreigners in possession of a work visa issued by the Department of Home Affairs (only one such foreigner may be employed on any project), shall include for a minimum allocation of:

- (a) 60% women;
- (b) 55% youth who are between the ages of 18 and 35; and
- (c) 2% persons with disabilities.

All labour recruitment, employment and associated risks shall remain the sole responsibility of the contractor.

The contractor shall comply with the minimum supervisor to worker ratio stated below, required to ensure the effective supervision of the Labour-enhanced works for all LEA activities undertaken on this project:

Minimum supervisor to worker ratio = 1:10

E2.4 Contract of employment with persons employed under the Expanded Public Works Programme (EPWP)

The Contractor shall enter into a formal contract of employment with each person employed under the Expanded Public Works Programme (EPWP), using the pro forma contract of employment attached at the end of this Part F of section 3.3 Particular Specifications.

The Contractor shall note that all such formal contracts of employment entered into with persons employed under the Expanded Public Works Programme (EPWP) shall expire on 31 March each year, and the Contractor shall therefore be required to enter into new contracts with such persons as of 1 April each year.

E2.5 Employment of targeted labour under the Expanded Public Works Programme (EPWP)

The Contractor shall be contractually obliged to:

- (a) brief EPWP workers on the conditions of employment;
- (b) enter into a formal contract of employment with each EPWP worker, which contract will form part of the Employment Agreement;
- (c) keep personnel files for all EPWP workers and make copies available to the Employer if and when requested; and
- (d) ensure that payments to EPWP workers are made in accordance with Government Notice No. R347.

The rate of pay for persons employed under the Expanded Public Works Programme (EPWP) shall be the gazetted rate:

- (i) per task (for task-rated workers); or
- (ii) per day (for time-rated workers).

During those periods when an EPWP worker is engaged in formal classroom training (other than in-service training), the rate of pay shall be equal to the minimum wage rate as set on an annual basis in the Ministerial Determination for the Expanded Public Works Programme.

Tasks set by the Contractor shall be such that:

- (a) the average EPWP worker completes 5 tasks per week in 40 hours or less; and
- (b) the weakest EPWP worker completes 5 tasks per week in 55 hours or less.

The Contractor shall revise the time taken to complete a task whenever it is established that the time taken per week to complete the tasks set does not fall within the limits indicated in (a) and (b) above.

E2.6 Training of persons employed under the Expanded Public Works Programme (EPWP)

The training of persons employed under the Expanded Public Works Programme (EPWP) is described in clause E4 below.

E2.7 Contractor's obligations towards persons employed under the Expanded Public Works Programme (EPWP)

Over and above implementing in accordance with Government Notice Nos. 129 and R347 the EPWP work to be undertaken on this contract, it shall be the responsibility of the Contractor to carry out the following functions with respect to the EPWP workers:

- (a) ensure that all participants are covered by the Compensation for Occupational Injuries and Diseases Act, 1993, for as long as they are contracted to the Contractor, and pay in full to the Compensation Commissioner such amounts as are due in terms of the Act;
- (b) pay in full to the Unemployment Insurance Fund for all participants such UIF contribution amounts as are due in terms of the Unemployment Insurance Act, 2001, as amended, and the Unemployment

- Insurance Contributions Act, 2002, as amended, and provide proof of such UIF payments upon request;
- (c) ensure that all participants are paid their wages on time through the pre-agreed payment method as stipulated in the participant contract of employment;
 - (d) implement health and safety procedures with respect to the participants, ensuring that the health and safety regulations are adhered to;
 - (e) ensure that all participants receive induction on site safety prior to commencing with work on site;
 - (f) provide all participants with the necessary protective clothing and equipment as required by law for the specific tasks in which the participants are involved, in addition to the branded overalls stipulated for EPWP workers;
 - (g) provide safe on-site storage facilities for apparel and tools issued to the participants;
 - (h) assist in the assessment of participants with regard to their competencies;
 - (i) provide overall supervision and day-to-day management of participants; and
 - (j) implement strict quality control to ensure that the work carried out by the participants is of the required standard, and, where necessary, to train and mentor the participants to assist them in achieving the standards required.

E2.8 Apparel and tools for persons employed under the Expanded Public Works Programme (EPWP)

The Contractor shall provide Personal Protective Equipment (PPE) to all EPWP workers in accordance with the requirements arising from Part D: OHS 1993 Health and Safety Specification and the Contractor's site-specific health and safety plan and accompanying risk assessments.

Where indicated below, certain items of the PPE issued by the Contractor to the EPWP workers shall include branded EPWP markings in accordance with the attached branding requirements.

PPE shall comprise the following:

- (a) Compulsory PPE issued to all EPWP workers for use during general work activities:
 - (i) Protective overalls (two sets), Pentone yellow in colour, with EPWP branding;
 - (ii) Lime green reflective safety vest with EPWP branding;
 - (iii) Protective footwear; and
 - (iv) Protective gloves.
- (b) PPE issued to EPWP workers for specific activities where required in terms of the Contractor's site-specific health and safety plan and accompanying risk assessments, such as:
 - (i) Protective headwear, green in colour, with EPWP branding;
 - (ii) Protective eyewear such as spectacles and goggles;
 - (iii) Protective face shields;
 - (iv) Protective earplugs and earmuffs;
 - (v) Respiratory masks;
 - (vi) Disposable safety apparel;
 - (vii) Kidney belts;
 - (viii) Safety harnesses; and
 - (ix) Any other protective equipment identified.

The Contractor shall replace any item of issued PPE that becomes unserviceable.

The Contractor shall not charge any fee to the EPWP workers for the prescribed PPE issued except under the following circumstances:

- (i) where the employee requests the issue of additional PPE in excess of what is prescribed;
- (ii) where the employee has patently abused or neglected the issued PPE leading to early failure; or
- (iii) where the employee has lost the issued PPE.

The Contractor shall instruct and train the EPWP workers in the use of all PPE issued, and shall ensure that they use the prescribed equipment.

EPWP workers shall not have the right to refuse to use or wear the equipment prescribed by the Contractor. If it is not possible for an EPWP worker, through health or any other reason, to use or wear the prescribed PPE issued, such employee shall not be allowed to continue working under the hazardous conditions for which the equipment was prescribed. Under such circumstances an alternative solution shall be found, and this may include relocating or discharging the employee.

The Contractor shall provide each EPWP worker with hand tools of adequate quality and of the type required to carry out the assigned tasks safely and efficiently.

The Contractor shall instruct and train the EPWP workers in the safe and efficient use of all hand tools issued.

The Contractor shall maintain the issued tools in a serviceable and safe working condition.

The EPWP workers shall be responsible for the safe on-site storage of all PPE and tools issued to them, using the storage facilities provided on site by the Contractor.

No separate payment shall be made for providing the EPWP workers with PPE, or for providing relevant items of PPE in the specified colours with branded EPWP markings. Furthermore, no separate payment shall be made for providing the EPWP workers with hand tools or for providing them with safe storage facilities on site for PPE and tools. The Contractor shall therefore make provision for all costs related to providing the PPE, tools and safe storage facilities in the tendered rates and prices for the various items of work scheduled throughout the bill of quantities.

E2.9 EPWP contract signboard

The Contractor will be required to erect a contract signboard displaying the EPWP logo, indicating that this project is part of the Expanded Public Works Programme (EPWP). Provision for the costs related to the provision, erection and subsequent removal of the contract signboard is made in pay item provided in chapter 1.3 of the bill of quantities for this purpose.

E2.10 Payment matters relating to the EPWP work

E2.10.1 General

No separate pay items shall be provided in terms of Part E of the bill of quantities for the construction work activities carried out by EPWP participants. Payment for such work activities shall be made only indirectly, in terms of the pay items scheduled for the work activities in which such persons are engaged.

Furthermore, no direct payment will be made to cover the Contractor's costs associated with implementing the on-site work programme for the EPWP participants, for planning, organising, directing, controlling and administrating their day to day activities, including the setting of daily tasks, record keeping and any on-site liaison, training and mentoring required, and for the associated job creation reporting, and such costs shall therefore be built into the rates tendered for the various items of work scheduled throughout the bill of quantities.

E2.10.2 Payment for labour-enhanced components of the work

Payment will be made for items which are designated for labour-enhanced construction in the bill of quantities only in those instances where such items are constructed using labour-enhanced methods.

Any unauthorised use of construction equipment to carry out work which was scheduled to be carried out using Labour-enhanced methods will not be condoned and any Works so constructed will not be certified for payment. Any non-payment for such Works shall not relieve the Contractor in any way from his obligations either in contract or in delict.

During the course of construction, as a result of unforeseen site conditions or operating conditions encountered, it may happen that an item designated for labour-enhanced construction can no longer be carried out in a safe and economically feasible manner, either in full or in part, using Labour-enhanced methods. In such instances the Employer's Agent shall, where necessary, order a variation in terms of clause

6.3 of the of the General Conditions of Contract 2015 with respect to that portion of the item quantity that cannot be carried out using labour-enhanced methods.

E2.11 Penalty applicable to any shortfall in the local labour content achieved

The amount spent on wages for local labour (excluding VAT) for this project, as certified by the Employer's Agent, shall equal or exceed the specified minimum percentage of the contract amount which is the Contract Price (adjusted to exclude penalties and value added tax).

The Contractor is obliged to commit to or exceed the specified minimum percentage of local labour content stated in section C1.2.2 Data Provided by the Employer.

In the event that the Contractor fails to substantiate that any failure to achieve the minimum required local labour content for this project is due to quantitative underruns, the elimination of items contracted to local labour, or any other reason beyond the Contractor's control which may be acceptable to the Employer, the Contractor shall be liable for a financial penalty as prescribed in clause SCC 4.1.1 of section C1.2.1.2 Special Conditions of Contract. The financial penalty shall be calculated as follows:

$$P = 0,05 \times [(E - E_0)/100] \times C_A$$

where:

- E is the specified minimum percentage for local labour content
- E₀ is the local labour content percentage which the Employer's Agent certifies as being achieved upon completion of the contract
- C_A is the contract amount which is the Contract Price (adjusted to exclude penalties and value added tax)
- P is the monetary value of penalty payable

The penalty shall not apply to shortfalls in the allocations to the individual target groups (i.e., Women/Youth/Disabled as per clause E1.3 above), only to shortfalls in the total local labour content achieved.

The evaluation of the Contractor's achievement of the local labour content percentage shall be undertaken monthly by the Employer's Agent, based on the accumulative achievements in comparison to the programmed utilisation of local labour, as a means of monitoring the Contractor's performance in achieving the Contract Participation Goal.

Failure by the Contractor to achieve the Contract Participation Goal target by the time of Practical Completion, shall result in the financial penalty being applied as prescribed in this clause. The Employer's Agent shall make a final determination of the Contractor's achievement of the Contract Participation Goal based on the value of the Final Payment Certificate.

E3. NATIONAL YOUTH SERVICE (NYS)

Note: The Contractor shall be required to employ NYS workers in terms of this contract.

The Employer requires the implementation of National Youth Service (NYS) programmes on this project.

E3.1 The National Youth Service (NYS) programme

The National Youth Service (NYS) programme aims to train young people and provide them with practical work experience. The young people will be allocated tasks by the Contractor that will assist the Contractor with the execution of the contract.

E3.2 Applicable labour laws

The work to be undertaken on this contract by unskilled or semi-skilled workers under the National Youth Service (NYS) programme shall be implemented in accordance with the same Code of Good Practice and Ministerial Determination as described in clause E2.2 above for work to be undertaken under the Expanded

Public Works Programme (EPWP).

E3.3 Employer's project manager

The Contractor shall be required to liaise closely with the Employer's project manager who is responsible for the recruitment and training of the NYS workers.

E3.4 Persons to be employed under the NYS programme

For purposes of this contract, the Contractor shall be required to employ 10 youths aged between 18 and 35 for a period of 6 months each under the NYS programme.

The Employer's project manager shall provide the Contractor with a list of the 10 youths to be employed and the training that each of these 10 youths have received to date, and only these 10 youths shall be employed by the Contractor under the NYS programme.

E3.5 Contract of employment with persons employed under the NYS programme

The Contractor shall enter into a formal contract of employment with each youth employed under the NYS programme, using the pro forma contract of employment attached at the end of this Part E of section 3.3 Particular Specifications.

E3.6 Employment of NYS workers

The Contractor will be contractually obliged to:

- (a) employ all participants on the list provided by the Employer's project manager;
- (b) brief NYS workers on the conditions of employment;
- (c) enter into a formal contract of employment with each NYS worker, which contract will form part of the Employment Agreement;
- (d) keep personnel files for all NYS workers and make copies available to the Employer's project manager if and when requested; and
- (e) ensure that payments to NYS workers are made in accordance with Government Notice No. R347.

During the period when they are engaged in formal classroom training (other than in-service training), the youths employed under the NYS programme shall be paid the minimum wage rate as set by the Department of Labour on an annual basis in the Ministerial Determination for the Expanded Public Works Programme, and should there be an upward adjustment in the rate the Contractor will be compensated accordingly. During the period when they are engaged in productive work activities required for elements of the Works, they shall be paid in terms of the wage rates stated in clause E2.5 above.

E3.7 Training of youth workers

All NYS workers will be placed on an extensive training programme that will include:

- (a) an induction into NYS and EPWP;
- (b) life skills training;
- (c) technical training focusing on a vocational skill to be used on the project (e.g. painting or carpentry); and
- (d) Entrepreneurship and business skills training.

All training will be arranged by the Employer's project manager, with whom the Contractor will be required to work closely to schedule the training sessions so that the timing of the training is aligned with the Contractor's work schedule and his demand for workers with specific skills. The Employer's project manager will make full details of the training programme available to the Contractor.

A compulsory 10-day life skills training must be provided before commencement of classroom training on NYS. This type of training must be provided by a NYDA accredited service provider as per the National Youth Service Framework from the National Department of Public Works.

The Contractor shall maintain comprehensive records of the training received by each NYS worker throughout the course of the contract, and shall submit to the Employer at each monthly site meeting a summary of the accumulated training received by each NYS worker.

The training of the NYS workers shall take place using the same training facility provided for the training of all other EPWP participants (refer to clause F5 below).

E3.8 Contractor's obligations towards persons employed under the NYS programme

Over and above implementing in accordance with Government Notice Nos. 129 and R347 the NYS programme work to be undertaken on this contract, it shall be the responsibility of the Contractor to carry out the following functions with respect to the NYS programme workers:

- (a) ensure that all participants are covered by the Compensation for Occupational Injuries and Diseases Act, 1993, for as long as they are contracted to the Contractor, and pay in full to the Compensation Commissioner such amounts as are due in terms of the Act;
- (b) pay in full to the Unemployment Insurance Fund for all participants such UIF contribution amounts as are due in terms of the Unemployment Insurance Act, 2001, as amended, and the Unemployment Insurance Contributions Act, 2002, as amended, and provide proof of such UIF payments upon request;
- (c) ensure that all participants are paid their wages on time through the pre-agreed payment method as stipulated in the participant contract;
- (d) implement health and safety procedures with respect to the participants, ensuring that the health and safety regulations are adhered to;
- (e) ensure that all participants receive induction on site safety prior to commencing with work on site;
- (f) provide all participants with the necessary protective clothing and equipment as required by law for the specific trades in which the participants are involved, in addition to the branded overalls stipulated for NYS workers;
- (g) provide safe on-site storage facilities for apparel and tools issued to the participants;
- (h) assist in the assessment of participants with regard to their competencies in their respective trades;
- (i) provide overall supervision and day-to-day management of participants; and
- (j) implement strict quality control to ensure that the work carried out by the participants is of the required standard, and, where necessary, to train and mentor the participants to assist them in achieving the standards required.

E3.9 Apparel and tools for NYS workers

The content of clause E2.8 above with regard to apparel and tools for EPWP workers shall apply equally to NYS workers, except that:

- (a) apparel and tools to be issued to NYS workers shall be determined in conjunction with the Employer's project manager;
- (b) the required branding of apparel to be issued to NYS workers shall be determined in conjunction with the Employer's project manager, and shall also include the NYS logo;
- (c) additional PPE may be required depending on the NYS worker's specific trade;
- (d) certain specified apparel and tools issued to the NYS workers will become the property of the NYS workers after the completion of their cycle of work on the project, in order to enable them to continue to practise their trade on future projects. Such apparel and tools shall be specified and authorised by the Employer's Agent; and
- (e) separate payment items have been provided in Part F of the bill of quantities to cover all costs associated with the provision of the necessary tools and apparel, including safety apparel, for the NYS workers, and the facilities for the safe storage thereof, all as authorised by the Employer's Agent.

E3.10 EPWP-NYS contract signboard

Where work takes place under the National Youth Service (NYS) programme, the NYS logo shall also be displayed on the EPWP contract signboard referred to in clause E2.9 above, indicating that this project is part of both the Expanded Public Works Programme (EPWP) and the NYS programme. Provision for the costs related to the provision, erection and subsequent removal of the contract signboard in the pay item provided in chapter 1.3 of the bill of quantities for this purpose.

E3.11 Payment matters relating to the NYS work

No direct payment will be made to cover the Contractor's costs associated with implementing the on-site work programme for the NYS workers, for planning, organising, directing, controlling and administering their day to day activities, including the setting of daily tasks, record keeping and any on-site liaison, training and mentoring required, and for the associated job creation reporting, and such costs shall therefore be built into the rates tendered for the various items of work scheduled throughout the bill of quantities.

E4. JOB CREATION REPORTING FOR EPWP

In order to assist the Employer in complying with the goal of creating EPWP job opportunities, the Contractor must provide the information specified in clause E4.1 below for reporting purposes.

In addition, the Contractor's payment certificates shall be accompanied by the information specified in clause E4.2 below.

E4.1 Type of project data required per project

Every EPWP project shall collect and keep specific project data for the purpose of EPWP progress reporting on a monthly basis, using the EPWP Data Collection Tool template (this will be made available to the Contractor in Microsoft Excel format - refer to the pro forma spreadsheets at the end of this Part E of the Particular Specifications).

The data that is required to be kept, maintained and reported on a monthly basis for each project includes:

E4.1.1 Participant (local labour) data

A participant list of the local labour employed must be maintained for every EPWP project. The data required in this participant list is indicated below. This data shall be recorded, checked and signed off by the Contractor, and shall be submitted to the Employer at each monthly site meeting. The participant list shall contain the following data and shall be kept and maintained on site for audit purposes:

- (a) Participant identity – name, surname, initials, date of birth and identity number (or other unique identifier) plus certified copy of ID book.
- (b) Participant profiles – nationality, gender, age, education level and disability status.
- (c) Work data for participants – daily wage to be received, number of calendar days training attended and number of calendar days worked.
- (d) Records of training – as required in terms of the EPWP Data Collection Tool template.

In addition, the signed contracts of employment between the Contractor and each EPWP participant shall be kept and maintained on site for audit purposes.

E4.1.2 Project work data

The project work data generally seeks to confirm the number of people at work daily on the project. This data shall be recorded, checked and signed off by the Contractor, and shall be submitted to the Employer at each monthly site meeting. The data shall be maintained on site by the Contractor, in order that it can be provided by the Employer to the National Department of Public Works upon request when the latter is undertaking sample auditing. These records shall be kept by the Contractor for a period of three years after contract completion should they be required for audit purposes.

The data shall include:

- (a) Daily attendance register – register for each day showing all the workers that were registered as being at work on that day. Attendance registers shall be completed on site on a daily basis and signed off by the Contractor on a weekly basis. Refer to pro forma attendance register attached at the end of this Part F of section 3.3.
- (b) Summary of monthly attendance.

E4.1.3 Project payment data

The project payment data generally seeks to confirm what was paid, for how much work and to whom. This data shall be recorded, checked and signed off by the Contractor, and shall be submitted to the Employer at each monthly site meeting.

It is required that the Contractor adopt one of the following methods as standard procedure for recording and maintaining this information:

- (a) Payment register – this is a list of the workers showing the wages paid to each worker, and signed off by each worker as proof of receipt and acceptance of payment. Information on this register must include the name of the worker, either an identity number or other unique identifier, the number of calendar days that the pay period covers, the wage rate and the total wages paid; or
- (b) Bank records showing the transfers to each worker account, signed off by the Contractor as proof of payment – these bank records must specifically show the name of the worker, either an identity number or other unique identifier, the period which the pay covers and the total wages paid.

The project payment data, as recorded and maintained by the Contractor in terms of either (a) or (b) above, must be available and applicable for the entire period for which the Employer claims an incentive reward for person-days of work created in terms of the project.

E4.1.4 Employment output data

The Contractor shall submit to the Employer at each monthly site meeting a progress report detailing production output compared to the programme of works, together with the data necessary to enable the Employer to calculate the following employment output data in accordance with the EPWP Data Collection Tool template:

- (a) Number of work opportunities created (where one work opportunity = paid work created for one individual on an EPWP project, for any period of time).
- (b) Number of person-days of work created (where one person-day = one day of work carried out by one individual). The total number of person-days of work created on a particular EPWP project shall be obtained by summing the total number of person-days worked by each individual employed during the course of that EPWP project.
- (c) Number of Full Time Equivalents (FTE) created (= total number of person-days of work created on the EPWP project divided by 230 working days). In terms of EPWP policy, one year of work created for one individual is assumed to comprise a total of 230 days of paid work carried out by that individual.
- (d) Average duration of work opportunities created (= total number of person-days of work created on the EPWP project divided by the number of work opportunities created on that EPWP project).
- (e) Average daily wage rates paid (= accumulated total of the wages paid to all individuals employed on an EPWP project divided by the total number of person-days of work created on that EPWP project).
- (f) Training information.

E4.2 Project data to be submitted with the Contractor's payment certificates

The Contractor's payment certificates shall be accompanied by labour returns providing the labour information for the corresponding period in a format specified by the Employer.

Should the Contractor choose to delay submitting payment certificates, the labour returns shall nevertheless still be submitted as per the frequency and timeframes stipulated by the Employer. The Contractor's payment certificates shall not be paid by the Employer until all pending labour information has been submitted.

The following information shall be maintained on site and submitted with each payment certificate in the format specified by the Employer:

- (a) Copies of the signed contracts between the Contractor and any new EPWP participants (the Contractor shall note that all such formal contracts of employment entered into with persons employed under the Expanded Public Works Programme (EPWP) shall expire on 31 March each year, and the Contractor shall therefore be required to enter into new contracts with such persons as of 1 April each year, and shall be required to submit copies of all such new contracts with the first payment certificate thereafter);
- (b) Certified ID copies of all local labour employed as EPWP participants;
- (c) Attendance registers for the EPWP participants;
- (d) Proof of payment of EPWP participants; and
- (e) Information as required in terms of the EPWP Data Collection Tool template.

E5. PROVISION OF STRUCTURED TRAINING

E5.1 Scope of structured training

In order to avoid duplication of training facilities, the training described in Part F: Small Contractor Development (in those instances where Part F is included in the contract), shall be provided utilising the training facility measured and paid for in accordance with the requirements of this Part F: Expanded Public Works Programme (EPWP).

The Employer's objectives include the training of local labour and Targeted Enterprises within a structured programme, in order to equip them with skills that will assist them in gaining future employment, and to facilitate targeted EPWP participants in gaining competencies and unit standard credits towards future full learnership qualifications.

Such training shall contain both theoretical and practical components and shall be conducted in accordance with the various laws and regulations contained in the South African Qualifications Authority (SAQA) statutes.

The following aspects of the structured training to be provided are noted:

- (a) The Employer has no service agreement or memorandum of understanding with any Education and Training Quality Assurance (ETQA) body, and therefore does not function as the employer as defined under any three-party learnership agreement between the learner, the training provider and the employer.
- (b) The structured training programmes implemented on this contract, although comprising several unit standards, are unlikely to total to sufficient credits for a full learnership qualification. Nevertheless, the competencies and credits achieved should contribute to a full learnership through the later acquisition by the learner of the remaining unit standards required for the full learnership.

The Contractor shall be required to provide a training facility on the Site, or in close proximity thereto, and to provide over the duration of the contract the following structured training for EPWP participants:

- (a) Generic skills training;
- (b) Entrepreneurial skills training;
- (c) Construction skills training; and
- (d) In-service training.

Generic skills training and in-service training shall be provided to all EPWP participants.

Entrepreneurial and construction skills training shall be provided to targeted EPWP participants only.

E5.2 Training provider and trainers

The Contractor shall be required to procure the services of a training provider accredited by the Construction Education and Training Authority (CETA).

The training provider shall have in its employ trainers who are registered as assessors with the Construction Education and Training Authority (CETA), and who shall deliver the training.

Proof of the accreditation of the service provider and the registration of the trainers by the CETA shall be submitted to the Employer's Agent. Such accreditation and registration shall be current and valid, and the proof submitted shall include the NQF levels and unit standards for which each trainer is accredited.

E5.3 Skills analysis and selection of targeted EPWP participants

Studying for any learnership requires minimum literacy and numeracy competencies as defined by SAQA. The actual literacy and numeracy levels of the persons employed on the Site shall provide a basis to guide the Contractor and the training provider on how to conduct the selection process.

The Contractor shall therefore conduct a skills analysis of the local labour and Targeted Enterprises employed, in order to determine the formal education qualifications of each employee.

The Contractor, in conjunction with the training provider, shall then identify those persons that display the potential to benefit from such structured entrepreneurial and construction skills training as may be provided for in the contract, and shall make recommendations in this regard to the Employer's Agent.

The final candidates selected for such training shall be decided between the Contractor and the Employer's Agent (or by the Project Management Team (PMT) in the case of training for Targeted Enterprises in terms of Part F: Small Contractor Development, where applicable).

E5.4 Structured training programmes

The Contractor, supported by the training provider, shall plan then implement structured training programmes for generic, entrepreneurial and construction skills training.

Training courses shall commence **within four months** of the Contractor taking possession of the Site, and shall be completed before the Due Completion Date.

All training shall take place within normal working hours, or as otherwise agreed with the learners.

The training provider shall design, compile and deliver the structured training programmes, based on the information obtained from the skills analysis.

E5.4.1 Generic skills training

The structured training programmes designed by the training provider for the generic skills training shall comprise relevant general courses such as basic hygiene and HIV/AIDS awareness, first aid, road safety, managing personal finance, and other courses that would be useful to workers in the road construction industry or as life skills generally.

E5.4.2 Entrepreneurial skills training

The structured training programmes designed by the training provider for the entrepreneurial skills training shall comprise unit standards that contribute towards one or more of the following full learnership qualifications, as appropriate taking into consideration the skills analysis information for the selected candidates (details of the learnership qualifications and the applicable unit standards may be found on the website www.saqa.org.za):

ENTREPRENEURIAL SKILLS TRAINING				
Qualification title	SAQA qualification ID	NQF level	Minimum credits	Purpose of qualification
National Certificate: Supervision of Construction Processes	49053	Level 4	176	Learners found competent against this qualification will be able to execute the supervision of construction processes, with specialisation in a specific context

E5.4.3 Construction skills training

The structured training programmes designed by the training provider for the construction skills training shall comprise unit standards that contribute towards one or more of the following full learnership qualifications, as appropriate taking into consideration the skills analysis information for the selected candidates (details of the learnership qualifications and the applicable unit standards may be found on the website www.saga.org.za):

CONSTRUCTION SKILLS TRAINING				
Qualification title	SAQA qualification ID	NQF level	Minimum credits	Purpose of qualification
National Certificate: Supervision of Construction Processes	49053	Level 4	176	Learners found competent against this qualification will be able to execute the supervision of construction processes, with specialisation in a specific context
National Certificate: Construction: Roadworks	24173	Level 3	155	This qualification is for persons who work or intend to work within a construction context on a site, and who seek recognition for essential skills in construction operations in roadworks.
National Certificate: Construction: Roadworks	24133	Level 2	120	This qualification is for persons who work or intend to work within a construction context on a site, and who seek recognition for essential skills in construction operations in roadworks.
National Certificate: Occupational Health, Safety and Environment	74269	Level 2	120	This qualification is to equip learners working in any type of workplace with a broad understanding and knowledge of Occupational Health, Safety and Environmental (HSE) concepts and practices with sufficient detail to enable them to function in a safe and healthy way and to deal with health and safety problems and issues.

E5.4.4 Training programme

The Contractor's proposed training programmes shall be subject to the approval of the Employer's Agent (or the approval of the Project Management Team (PMT) in the case of training for Targeted Enterprises in terms of Part F: Small Contractor Development, where applicable), and the Contractor shall, if so instructed by the Employer's Agent or the PMT, alter or amend the programmes and the course content to meet any additional needs identified.

The Contractor shall be responsible for everything necessary for the delivery of the training programmes, including:

- (a) the provision of the trainers;
- (b) the provision of a suitable secure venue, complete with adequate furniture, lighting, air conditioning, power and ablution facilities;
- (c) the provision of all necessary stationery, consumables and study materials;
- (d) the transportation of the learners to and from the training facility;
- (e) the payment of wages to all learners during the classroom training at a rate equal to the minimum wage rate as set on an annual basis in the Ministerial Determination for the Expanded Public Works Programme;
- (f) the provision of any relevant Personal Protective Equipment (PPE) required for the training; and
- (g) additional supervision of the learners during the practical learning stage of the training carried out by constructing relevant elements of the Works (wages for the learners during this stage of the training will be paid through the rates tendered for the relevant scheduled work items for those elements).

At the successful completion of each course, the Contractor's training provider shall, as proof of attendance and completion, issue each learner with a certificate indicating the course content.

The training provider shall also ensure that each unit standard contributing towards a full learnership qualification and successfully completed by the learner is entered onto the national database.

The Contractor shall keep comprehensive records of the training given to each learner and the certificates issued, and shall provide copies of such records to the Employer's Agent when required.

The Contractor shall also complete and submit to the Employer's Agent each month, in a format acceptable to the Employer (using the EPWP Data Collection Tool template), a return detailing the training provided, both for the month and cumulatively for the contract.

E5.5 In-service training

The Contractor shall, from the commencement of the contract, implement an in-service training programme in which the various skills required for the execution and completion of the Works are imparted to the EPWP participants engaged thereon.

Throughout the duration of the contract, the EPWP participants shall be trained progressively through the various stages of each particular type of work in which they are engaged, and their work shall be supervised and monitored and their methods corrected where necessary.

The in-service training programme shall be submitted with the initial Works programme. The Contractor shall record the progress in relation to this programme on a monthly basis, and this progress report shall be incorporated in the monthly site meeting minutes and the payment certificate.

The Contractor shall provide sufficient skilled and competent trainers to train all EPWP participants engaged on the contract in the various skills required to enable them to carry out the required construction activities.

The in-service training of EPWP participants shall take place before commencement of the relevant construction activity, and the Contractor shall take into account in his programme the lead time required for such training. All in-service training shall be deemed to be an element of the relevant construction activity.

All formal in-service training shall be documented in terms of the EPWP Data Collection Tool template, and shall be accompanied by an attendance register of the EPWP participants on the applicable days.

All EPWP participants shall be remunerated at their agreed wage rate in respect of the time spent undergoing in-service training. The cost of the Contractor's in-service training obligations shall be deemed to be covered by the sums and rates tendered for items B13.01(a), (b) and (c) in the bill of quantities.

On termination of their employment, the Contractor shall provide each EPWP participant engaged on the contract with a certificate of service on which the following information shall be recorded:

- (i) name of the Contractor;
- (ii) name of the project / contract;
- (iii) name of the employee;
- (iv) nature of the work satisfactorily executed by the EPWP participant and the time spent thereon;
- (v) nature and extent of training provided to the EPWP participant; and
- (vi) dates of service.

E5.6 Training venue facility

The training venue facility to be provided by the Contractor shall be constructed, furnished and fully serviced for the duration of the contract in accordance with Chapter 1.4 of the Standard Specifications for Road and Bridge Works for South African Road Authorities (COTO), Draft Standard (DS), October 2020.

In order to minimise the cost of transporting the learners for training, the facility shall be located in secure premises on the Site, or in close proximity thereto.

This facility shall be used to deliver all training, irrespective of whether it is delivered in terms of Part E or Part F of the Particular Specifications.

The facility shall accommodate a class of up to 25 learners and shall comprise the following:

(a)	Lecture room (interior area)	=	48 m ²
(b)	Ablutions (male)	=	6 m ²
(c)	Ablutions (female)	=	6 m ²
(d)	Chairs for learners (individual chairs, with backs)	=	25 off
(e)	Desk area for 25 learners (500 mm width)	=	12,5 m ²
(f)	Chairs for trainers and management (individual chairs, with backs)	=	5 off
(g)	Table area for trainers and management	=	3 m ²
(h)	220/250 volt power points	=	6 off
(i)	Double 80 watt fluorescent light fittings complete with ballast and tubes	=	6 off
(j)	Single incandescent light fittings complete with 100 watt globes	=	4 off
(k)	Wash hand basins complete with taps and drains	=	4 off
(l)	Fire extinguishers, 9,0 kg, all-purpose dry powder type, complete, mounted on wall with brackets	=	2 off
(m)	Air conditioning units with 2,2 kW minimum capacity, mounted and with own power connection	=	4 off
(n)	Voltage stabilizers	=	2 off
(o)	Floodlights complete with poles and 500 watt minimum globes and controlled by photocells	=	2 off
(p)	White boards (3 m x 1,5 m)	=	1 off
(q)	Venetian blinds	=	12 m ²

E6. MEASUREMENT AND PAYMENT

Item	Unit
E6.01 Provision of the training venue facility, including the cost of transporting the learners to and from this facility	lump sum (Sum)

The tendered lump sum for sub item E6.01 shall include full compensation for the provision of the training

venue facility complete and serviced as specified, including for the provision of power, water, sewerage and cleaning services for the duration of the contract, for lighting, power points and voltage stabilizers, for air conditioning, blinds, fire extinguishers, floodlights, furniture and whiteboards, for the provision of security at the facility, for all other costs necessary to maintain the facility for the duration of the contract, and for the removal of the facility on completion of the contract.

The tendered lump sum shall also include full compensation for transporting the learners on each day of training from their place of work to this training venue facility, and back again after the training for the day has been delivered by the accredited trainers.

Payment of the lump sum shall be made in three instalments as follows:

The first instalment, 50% of the lump sum, shall be paid after the Contractor has met all his obligations regarding the provision of the training venue facility, complete and serviced as specified, and the facility has been successfully commissioned for use.

The second instalment, 35% of the lump sum, shall be paid when 75% of the training courses proposed in accordance with the Contractor's approved structured training programme have been delivered to the learners by the accredited trainers.

The third and final instalment, 15% of the lump sum, shall be paid when all training has been concluded and the facility has been dismantled and removed from the site.

Item	Unit
E6.02 Training of learners employed by the contractor or by the Targeted Enterprise subcontractors:	
(a) Generic skills:	
(i) Training costs.....	provisional sum (Prov sum)
(ii) Handling costs and profit in respect of sub item E6.02(a)(i)	percentage (%)
(b) Entrepreneurial skills:	
(i) Training costs.....	provisional sum (Prov sum)
(ii) Handling costs and profit in respect of sub item E6.02(b)(i).....	percentage (%)
(c) Construction skills:	
(i) Training costs.....	provisional sum (Prov sum)
(ii) Handling costs and profit in respect of sub item E6.02(c)(i)	percentage (%)
(d) Transportation and accommodation costs of selected learners only, while receiving off-site training:	
(i) Transportation and accommodation costs.....	provisional sum (Prov sum)
(ii) Handling costs and profit in respect of sub item E6.02(d)(i).....	percentage (%)

Expenditure under sub items E6.02(a)(i), (b)(i), (c)(i) and (d)(i) shall be in accordance with clause 6.6 of the General Conditions of Contract 2015.

The provisional sum for each of sub items E6.02(a)(i), (b)(i) and (c)(i) is provided to cover the total costs of the required training in generic, entrepreneurial and construction skills respectively, including for the

procurement of the services of the accredited trainers and their delivery of the training courses to the learners, the provision of all training materials including all stationery and study materials, the wages of the learners for the duration of the courses including the associated COIDA and UIF payments, and the provision of any tools and PPE that may be required during those courses incorporating practical training modules. The payment of wages to learners in terms of sub items E6.02(a)(i), (b)(i) and (c)(i) will only be made to those learners who attend and successfully complete each course of the approved training programme. Payment shall not be made to learners who, once selected, do not attend or only partially complete structured training courses.

The tendered percentage for each of sub items E6.02(a)(ii), (b)(ii) and (c)(ii) is the percentage of the amount actually spent under each of sub items E6.02(a)(i), (b)(i) and (c)(i) respectively, and shall include full compensation for the handling costs of the Contractor and the profit in connection with the provision of the training in generic, entrepreneurial and construction skills respectively, including for the costs of record keeping and reporting with respect to the training received by each learner.

The provisional sum for sub item E6.02(d)(i) is provided to cover all costs related to the transportation and accommodation costs of selected learners only, while receiving off-site training, where such learners have been specifically selected to receive such off-site training and where such training cannot be delivered using the training venue facility provided by the Contractor in terms of sub item E6.01.

The tendered percentage for sub item E6.02(d)(ii) is the percentage of the amount actually spent under sub item E6.02(d)(i), and shall include full compensation for the handling costs of the Contractor and the profit in connection with the transportation and accommodation costs of selected learners only, while receiving off-site training.

Item	Unit
E6.03	
Payments associated with the NYS programme:	
(a) Employment of NYS workers	provisional sum (Prov sum)
(b) Provision of tools and apparel for the NYS workers	provisional sum (Prov sum)
(c) Handling costs and profit in respect of sub items E6.03(a) and (b)	percentage (%)
(d) Training of NYS workers:	
(i) Provision of training for NYS workers	provisional sum (Prov sum)
(ii) Handling costs and profit in respect of sub item E6.03(d)(i)	percentage (%)
(e) Liaison with the Employer's project manager and the training service provider:	
(i) Liaison conducted by the Construction Manager.....	hour (h)
(ii) Liaison conducted by the senior site foreman.....	hour (h)

The provisional sums provided under sub items E6.03(a) and (b) shall be expended in accordance with clause 6.6 of the General Conditions of Contract 2015.

The provisional sum under sub item E6.03(a) shall be used to cover the cost of employment payments made by the Contractor to the NYS workers, including the associated COIDA and UIF payments, all as authorised by the Employer's Agent.

The provisional sum under sub item E6.03(b) shall be used to cover all costs associated with the provision of the necessary tools and apparel, including safety apparel, for the NYS workers, and the facilities for the safe storage thereof, all as authorised by the Employer's Agent.

The tendered percentage under sub item E6.03(c) is a percentage of the total amount of expenditure approved by the Employer's Agent under the provisional sum subitems E6.03(a) and (b), and shall include full compensation for attendance by the Contractor, for the handling costs of the Contractor, and for the profit in connection with payments made by the Contractor with respect to the NYS programme implementation.

The provisional sum provided under sub item E6.03(d)(i) shall be expended in accordance with clause 6.6 of the General Conditions of Contract 2015.

The provisional sum under sub item E6.03(d)(i) shall be used to cover all costs associated with the provision of training for the NYS workers, including the cost of procuring the services of the accredited trainers and their delivery of the training courses to the NYS workers, and the provision of all training materials including all stationery and study materials.

The tendered percentage under sub item E6.03(d)(ii) is a percentage of the total amount of expenditure approved by the Employer's Agent under the provisional sum sub item E6.03(d)(i), and shall include full compensation for attendance by the Contractor, for the handling costs of the Contractor, and for the profit in connection with payments made by the Contractor with respect to the provision of training for the NYS workers, including for the costs of record keeping and reporting with respect to the training received by each NYS worker.

The unit of measurement for sub items E6.03(e)(i) and (ii) shall be the hour. The tendered rates shall include full compensation for all costs related to the Construction Manager and the senior site foreman respectively for time spent at formal liaison meetings authorised and convened by the Employer's Agent for the specific purpose of liaising with the Employer's project manager and / or the training service provider. The payment shall be made only for the time spent in the formal meeting itself. No payment shall be made for time spent during any other on-site liaison, telephonic liaison, e-mail or written correspondence liaison between these parties, or for liaison conducted with the Employer's project manager and / or the training service provider by any other member of the Contractor's site staff or head office personnel, the cost of all of which shall be deemed to be included in the Contractor's time-related obligations under sub item B1.3.01(c).

Expanded Public Works Programme: PPE BRANDING For EPWP Projects



T-Shirt/Overall/Safety Vest Branding

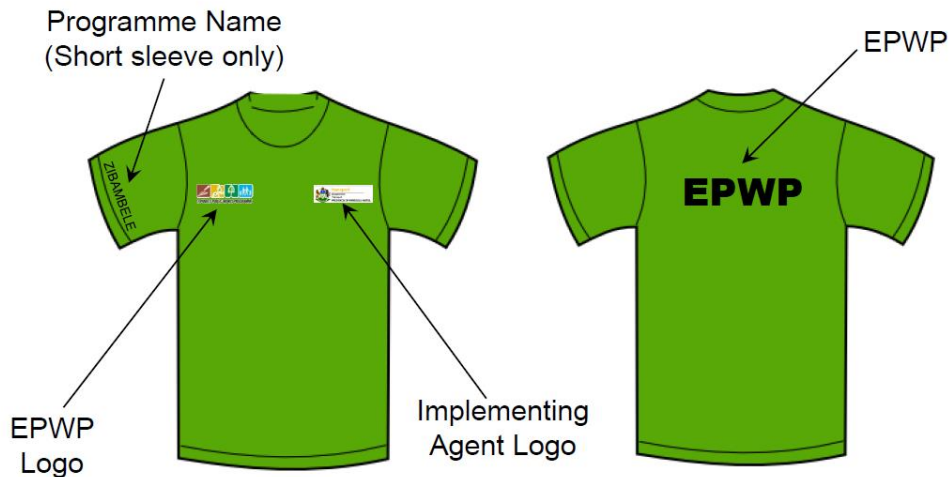

Logo Options

Implementing Agent Examples

National Projects



Provincial Department Projects



Municipal Projects



Contains National Coat Of Arms and name

Contains Provincial Coat Of Arms and name

EPWP LOGO



EXPANDED PUBLIC WORKS PROGRAMME

The Logo shall not be disproportionately stretched. A monochrome black logo may be used on approval only.

The above logo is the current logo. Logos with green text below the words EXPANDED PUBLIC WORKS PROGRAMME are old logos and should not be utilised.



PLEASE VERIFY WHICH LOGO NEEDS TO USED

Printing on PPE

PPE (Overalls) shall be Pantone Green with/without reflective tape and shall be branded as follows:

- Implementer's Logo (printed or embroidered) on the left front pocket location ie over the heart position. (full colour)
- EPWP logo on the right front pocket (printed or embroidered) location (full colour)
- The letters EPWP on the back of the PPE in BLACK
- The program name eg Vuk'uphile is to be printed on the right sleeve of short sleeved apparel and need not be placed on long sleeved apparel.
- Where required, lime green safety vests are to be branded with similar specification above. In this instance the Overalls may not necessarily be branded provided that the use of high visibility vests is mandatory.
- All artwork and PPE samples shall be approved and signed off by the consultant prior to printing/embroidering.



Project Signboard

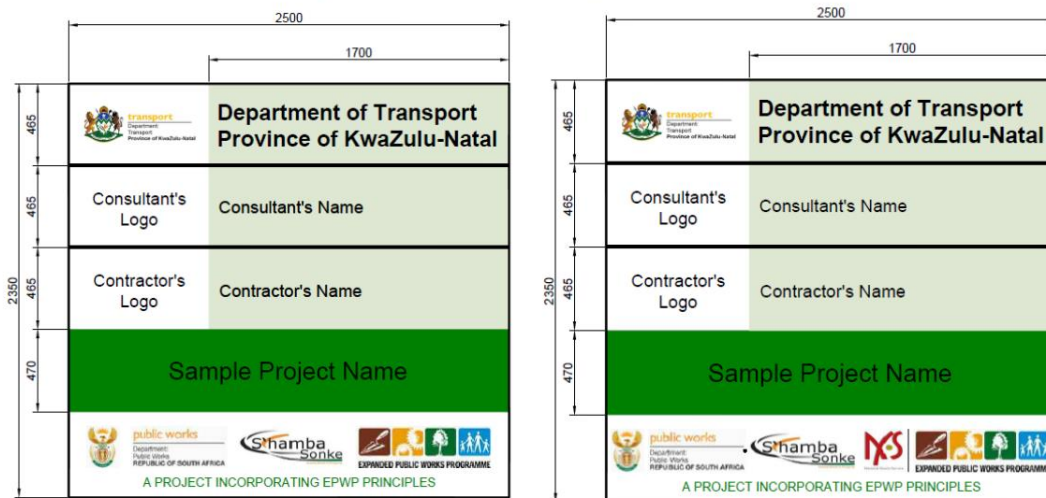

For further information contact:

Petronella Sithebe

Petronella.Sithebe@Kzntransport.gov.za

033-355-8023



PRO FORMA EPWP CONTRACT OF EMPLOYMENT

Contractor's
Logo



EXPANDED PUBLIC WORKS PROGRAMME

This contract must be read in conjunction with the standard terms and conditions of employment on EPWP attached herein.

EPWP CONTRACT OF EMPLOYMENT between

Employer Details

Name	Click or tap here to enter text.	Address	Click or tap here to enter text.
Telephone	Click or tap here to enter text.		
Email	Click or tap here to enter text.		
Contact	Click or tap here to enter text.		

And

Employee Details

Name	Click or tap here to enter text.	Surname	Click or tap here to enter text.
ID:	Click or tap here to enter text.	Cell	Click or tap here to enter text.
Sex (M/F)	Male <input type="checkbox"/> Female <input type="checkbox"/>	Disability	Yes <input type="checkbox"/> No <input type="checkbox"/>
Primary Language	Click or tap here to enter text.	Physical Address	Click or tap here to enter text.
Other Languages	Click or tap here to enter text.		
Highest Education Level Achieved	Click or tap here to enter text.	Local Municipality	Click or tap here to enter text.
Other qualifications	Click or tap here to enter text.	Ward	Click or tap here to enter text.
Grant Received (Y/N)	Yes <input type="checkbox"/> No <input type="checkbox"/>	Grant type:	

Employment Details

Name of project:	Click or tap here to enter text.		
Job Title:	Click or tap here to enter text.		
Duties:	Click or tap here to enter text.		
Contract Start Date	Click or tap here to enter text.	Contract Finish Date	Click or tap here to enter text.
The wage per task/day is:	R Click or tap here to enter text. / Hour/Day/task <i>(Specifier to select correct rate)</i>		

Special Conditions

<p>You must be aware that this employment contract is a limited term contract and not a permanent job. This employment contract may be terminated for any one of the following reasons:</p> <ul style="list-style-type: none"> a) The contractor does not get additional contracts from the EPWP. b) Funding for the programme in your area comes to an end. c) Underperformance: first offence – final written warning. Second offence – dismissal. 	<p>Payment</p> <ul style="list-style-type: none"> a) You will be paid a fixed amount stipulated above for completing a fixed amount of work. b) The amount of work required for the agreed rate of pay will vary from task to task. You will be informed at the beginning of each task or group of tasks how much work you are expected to complete per day. c) You will only be paid for work completed. d) Payment during classroom training shall be R /day
<p>Personal Protective Clothing will be supplied to the employee by the employer depending on the work to be performed, and will remain the property of the employee provided that the employee has worked for at least 3 months.</p>	

Acceptance

Employer Name:	Employer Signature:	Employee Name:	Employee Signature:
Witness 1 Name:	Witness 1 Signature:	Witness 2 Name:	Witness 2 Signature:

APPENDIX E – Conditions of Service

1. Introduction

1.1. This document contains the standard terms and conditions for workers employed in elementary occupations on an Expanded public Works Programme (EPWP). These terms and conditions do NOT apply to persons employed in the supervision and management of an EPWP.

1.2. In this document –

- a) “department” means any department of the State, implementing agent or contractor;
- b) “employer” means any department, implementing agency or contractor that hires workers to work in elementary occupations on an EPWP;
- c) “worker” means any person working in an elementary occupation on an EPWP;
- d) “elementary occupation” means any occupation involving unskilled or semi-skilled work;
- e) “management” means any person employed by a department or implementing agency to administer or execute an EPWP;
- f) “task” means a fixed quantity of work;
- g) “task-based work” means work in which a worker is paid a fixed rate for performing a task;
- h) “task-rated worker” means a worker paid on the basis of the number of tasks completed;
- i) “time-rated worker” means a worker paid on the basis of the length of time worked.

2. Terms of Work

- 2.1. Workers on an EPWP are employed on a temporary basis.
- 2.2. A worker may NOT be employed for longer than 24 months in any five-year cycle on an EPWP.
- 2.3. Employment on an EPWP does not qualify as employment as a contributor for the purposes of the Unemployment Insurance Act 30 of 1966.

3. Normal Hours of Work

- 3.1. An employer may not set tasks or hours of work that require a worker to work–
 - a) more than forty hours in any week
 - i. on more than five days in any week; and
 - ii. for more than eight hours on any day.
- 3.2. An employer and worker may agree that a worker will work four days per week. The worker may then work up to ten hours per day.
- 3.3. A task-rated worker may not work more than a total of 55 hours in any week to complete the tasks allocated (based on a 40-hour week) to that worker.

4. Meal Breaks

- 4.1. A worker may not work for more than five hours without taking a meal break of at least thirty minutes duration.
- 4.2. An employer and worker may agree on longer meal breaks.
- 4.3. A worker may not work during a meal break. However, an employer may require a worker to perform duties during a meal break if those duties cannot be left unattended and cannot be performed by another worker. An employer must take reasonable steps to ensure that a worker is relieved of his or her duties during the meal break.
- 4.4. A worker is not entitled to payment for the period of a meal break. However, a worker who is paid on the basis of time worked must be paid if the worker is required to work or to be available for work during the meal break.

5. Special Conditions for Security Guards

- 5.1. A security guard may work up to 55 hours per week and up to eleven hours per day.
- 5.2. A security guard who works more than ten hours per day must have a meal break of at least one hour or two breaks of at least 30 minutes each.

6. Daily Rest Period

Every worker is entitled to a daily rest period of at least eight consecutive hours. The daily rest period is measured from the time the worker ends work on one day until the time the worker starts work on the next day.

7. Weekly Rest Period

Every worker must have two days off every week. A worker may only work on their day off to perform work which must be done without delay and cannot be performed by workers during their ordinary hours of work (“emergency work”).

8. Work on Sundays and Public Holidays

- 8.1. A worker may only work on a Sunday or public holiday to perform emergency or security work.
- 8.2. Work on Sundays is paid at the ordinary rate of pay.
- 8.3. A task-rated worker who works on a public holiday must be paid –
 - a) the worker’s daily task rate, if the worker works for less than four hours;
 - b) double the worker’s daily task rate, if the worker works for more than four hours.
- 8.4. A time-rated worker who works on a public holiday must be paid –
 - a) the worker’s daily rate of pay, if the worker works for less than four hours on the public holiday;
 - b) double the worker’s daily rate of pay, if the worker works for more than four hours on the public holiday.

9. Sick Leave

- 9.1. Only workers who work four or more days per week have the right to claim sick-pay in terms of this clause.
- 9.2. A worker who is unable to work on account of illness or injury is entitled to claim one day’s paid sick leave for every full month that the worker has worked in terms of a contract.
- 9.3. A worker may accumulate a maximum of twelve days’ sick leave in a year.
- 9.4. Accumulated sick-leave may not be transferred from one contract to another contract.
- 9.5. An employer must pay a task-rated worker the worker’s daily task rate for a day’s sick leave.
- 9.6. An employer must pay a time-rated worker the worker’s daily rate of pay for a day’s sick leave.
- 9.7. An employer must pay a worker sick pay on the worker’s usual payday.
- 9.8. Before paying sick-pay, an employer may require a worker to produce a certificate stating that the worker was unable to work on account of sickness or injury if the worker is –
 - a) absent from work for more than two consecutive days; or
 - b) absent from work on more than two occasions in any eight-week period.
- 9.9. A medical certificate must be issued and signed by a medical practitioner, a qualified nurse or a clinic staff member authorised to issue medical certificates indicating the duration and reason for incapacity.
- 9.10. A worker is not entitled to paid sick-leave for a work-related injury or occupational disease for which the worker can claim compensation under the Compensation for Occupational Injuries and Diseases Act.

Employer	Employee
----------	----------

10. Maternity Leave

- 10.1. A worker may take up to four consecutive months' unpaid maternity leave.
- 10.2. A worker is not entitled to any payment or employment-related benefits during maternity leave.
- 10.3. A worker must give her employer reasonable notice of when she will start maternity leave and when she will return to work.
- 10.4. A worker is not required to take the full period of maternity leave. However, a worker may not work for four weeks before the expected date of birth of her child or for six weeks after the birth of her child, unless a medical practitioner, midwife or qualified nurse certifies that she is fit to do so.
- 10.5. A worker may begin maternity leave –
 - a) four weeks before the expected date of birth; or
 - b) on an earlier date –
 - i. if a medical practitioner, midwife or certified nurse certifies that it is necessary for the health of the worker or that of her unborn child; or
 - ii. if agreed to between employer and worker; or
 - iii. on a later date, if a medical practitioner, midwife or certified nurse has certified that the worker is able to continue to work without endangering her health.
- 10.6. A worker who has a miscarriage during the third trimester of pregnancy or bears a stillborn child may take maternity leave for up to six weeks after the miscarriage or stillbirth.
- 10.7. A worker who returns to work after maternity leave, has the right to start a new cycle of twenty-four months employment, unless the EPWP on which she was employed has ended.

11. Family responsibility leave

- 11.1. Workers, who work for at least four days per week, are entitled to three days paid family responsibility leave each year in the following circumstances -
 - a) when the employee's child is born;
 - b) when the employee's child is sick;
 - c) in the event of a death of –
 - i. the employee's spouse or life partner;
 - ii. the employee's parent, adoptive parent, grandparent, child, adopted child, grandchild or sibling.

12. Statement of Conditions

- 12.1. An employer must give a worker a statement containing the following details at the start of employment –
 - a) the employer's name and address and the name of the EPWP;
 - b) the tasks or job that the worker is to perform; and
 - c) the period for which the worker is hired or, if this is not certain, the expected duration of the contract;
 - d) the worker's rate of pay and how this is to be calculated;
 - e) the training that the worker will receive during the EPWP.
- 12.2. An employer must ensure that these terms are explained in a suitable language to any employee who is unable to read the statement.
- 12.3. An employer must supply each worker with a copy of these conditions of employment.

13. Keeping Records

- 13.1. Every employer must keep a written record of at least the following –
 - a) the worker's name and position;
 - b) in the case of a task-rated worker, the number of tasks completed by the worker;
 - c) in the case of a time-rated worker, the time worked by the worker;
 - d) payments made to each worker.
- 13.2. The employer must keep this record for a period of at least three years after the completion of the EPWP.

14. Payment

- 14.1. An employer must pay all wages at least monthly in cash or by cheque or into a bank account.
- 14.2. A task-rated worker will only be paid for tasks that have been completed.
- 14.3. An employer must pay a task-rated worker within five weeks of the work being completed and the work having been approved by the manager or the contractor having submitted an invoice to the employer.
- 14.4. A time-rated worker will be paid at the end of each month.
- 14.5. Payment must be made in cash, by cheque or by direct deposit into a bank account designated by the worker.
- 14.6. Payment in cash or by cheque must take place –
 - a) at the workplace or at a place agreed to by the worker;
 - b) during the worker's working hours or within fifteen minutes of the start or finish of work;
 - c) in a sealed envelope which becomes the property of the worker.
- 14.7. An employer must give a worker the following information in writing –
 - a) the period for which payment is made;
 - b) the numbers of tasks completed or hours worked;
 - c) the worker's earnings;
 - d) any money deducted from the payment;
 - e) the actual amount paid to the worker.
- 14.8. If the worker is paid in cash or by cheque, this information must be recorded on the envelope and the worker must acknowledge receipt of payment by signing for it
- 14.9. If a worker's employment is terminated, the employer must pay all monies owing to that worker within one month of the termination of employment.

15. Deductions

- 15.1. An employer may not deduct money from a worker's payment unless the deduction is required in terms of a law.
- 15.2. An employer must deduct and pay to the SA Revenue Services any income tax that the worker is required to pay.
- 15.3. An employer who deducts money from a worker's pay for payment to another person must pay the money to that person within the time period and other requirements specified in the agreement law, court order or arbitration award concerned.
- 15.4. An employer may not require or allow a worker to –
 - a) repay any payment except an overpayment previously made by the employer by mistake;
 - b) state that the worker received a greater amount of money than the employer actually paid to the worker; or
 - c) pay the employer or any other person for having been employed.

16. Health and Safety

- 16.1. Employers must take all reasonable steps to ensure that the working environment is healthy and safe.
- 16.2. A worker must –
 - a) work in a way that does not endanger his/her health and safety or that of any other person;
 - b) obey any health and safety instruction;
 - c) obey all health and safety rules of the EPWP;
 - d) use any personal protective equipment or clothing issued by the employer;
 - e) report any accident, near-miss incident or dangerous behaviour by another person to their employer or manager.

17. Compensation for Injuries and Diseases

Employer	Employee
----------	----------

- 17.1. It is the responsibility of the employers (other than a contractor) to arrange for all persons employed on an EPWP to be covered in terms of the Compensation for Occupational Injuries and Diseases Act, 130 of 1993.
- 17.2. A worker must report any work-related injury or occupational disease to their employer or manager.
- 17.3. The employer must report the accident or disease to the Compensation Commissioner.
- 17.4. An employer must pay a worker who is unable to work because of an injury caused by an accident at work 75% of their earnings for up to three months. The employer will be refunded this amount by the Compensation Commissioner. This does NOT apply to injuries caused by accidents outside the workplace such as road accidents or accidents at home.

18. Termination

- 18.1. The employer may terminate the employment of a worker for good cause after following a fair procedure.
- 18.2. A worker will not receive severance pay on termination.
- 18.3. A worker is not required to give notice to terminate employment. However, a worker who wishes to resign should advise the employer in advance to allow the employer to find a replacement.
- 18.4. A worker who is absent for more than three consecutive days without informing the employer of an intention to return to work will have terminated the contract. However, the worker may be re-engaged if a position becomes available for the balance of the 24-month period.
- 18.5. A worker who does not attend required training events, without good reason, will have terminated the contract. However, the worker may be re-engaged if a position becomes available for the balance of the 24-month period.

19. Certificate of Service

- 19.1. On termination of employment, a worker is entitled to a certificate stating –
 - a) the worker's full name;
 - b) the name and address of the employer;
 - c) the EPWP on which the worker worked;
 - d) the work performed by the worker;
 - e) any training received by the worker as part of the EPWP;
 - f) the period for which the worker worked on the EPWP;
 - g) any other information agreed on by the employer and worker.Either party can terminate this agreement with four weeks written notice. In the case where an employee is illiterate notice may be given by that employee verbally.

Employer	Employee
----------	----------

**EPWP DATA COLLECTION TOOL TEMPLATE
(PRO FORMAS OF MICROSOFT EXCEL SPREADSHEETS)**

EPWP REGISTRATION FORM		
Field requested	Description if needed	Please complete the sections in white
Project Details		
Profile ID	<i>Generated by the system</i>	
Project Name	<i>The name of the project</i>	
Project Reference Number	<i>Contract number</i>	
Project description	<i>Full description of what is happening in the project (as per the appointment letter) and the community benefiting from the project</i>	
Duration		
Project Start Date	<i>Planned Start date of the particular contract</i>	
Project End Date	<i>Planned End date of the particular contract</i>	
Estimated Budget	<i>Overall Contract budget (excluding professional fees) for Current Financial Year</i>	
Project Location		
Province	<i>In which province is the project implemented?</i>	KZN
District Municipality	<i>Under which District Municipality does this project falls?</i>	
Local Municipality	<i>Under which Local Municipality does this project falls?</i>	
Latitude (in decimal format)	<i>Is generated by the system</i>	
Longitude (in decimal format)	<i>Is generated by the system</i>	
Project Location per site		
Locality name	<i>Where exactly is the project implemented? (Ward name)</i>	
Subplace	<i>Town / Village</i>	
Ward	<i>The project site is located in which ward?</i>	
Government facility	<i>Landmark near the project (Post office/school/clinic/library)</i>	
Spatial Data Type	<i>Geopoint (structure)/ Line (road)/ Polygon(area)</i>	
Site physical address	<i>Physical address of the site office</i>	
Public Body Details		
Public body sphere	<i>In which sphere is the project implemented? (National, Provincial or Municipal)</i>	Provincial
Reporting public body that is the project owner (and will report on the project)	<i>Which Institution or Department that owns / approved this project (Education, Health, City of Tshwane Metro etc.)</i>	KZN Department of Transport
Department in the Public body that is responsible for the project	<i>Which department /unit is responsible for this project? (e.g. Roads & storm water, Education, Community safety etc.)</i>	KZN Department of Transport
Implementing public body type	<i>In which sphere is this project implemented? (Metro, Distr, Mun, National or Provincial Dept.)</i>	Provincial
Public body that will implement the project	<i>Which institution that implements the project?</i>	KZN Department of Transport
Project Implementation		
Is this the project on the municipal IDP	<i>Yes / No</i>	N/A
IDP reference number allocated to the project	<i>The number reflected in your Municipal IDP document</i>	N/A
EPWP Details		
EPWP Sector	<i>The project is implemented in which sector? (Infrastructure, Environment & culture, Non-state or Social)</i>	Infrastructure
EPWP Programme	<i>The project is implemented under which programme?</i>	
EPWP Sub Programme	<i>The project is implemented under which sub-programme?</i>	

EPWP BUSINESS FORM		
Field requested	Description if needed	Please complete the sections in white
Project Details		
Profile ID	<i>Generated by the system</i>	
Project Name	<i>The name of the project</i>	
Project Reference Number	<i>Contract number</i>	
Project description	<i>Full description of what is happening in the project (as per the appointment letter) and the community benefiting from the project</i>	
Duration		
Project Start Date		
Project End Date		
Estimated Budget	<i>Project Budget</i>	
Project Location		
Province		KZN
District Municipality	<i>Under which District Municipality does this projects falls</i>	
Local Municipality	<i>Under which Local Municipality does this projects falls</i>	
Latitude (in decimal format)	<i>GPS coordinates</i>	
Longitude (in decimal format)		
Public Body Details		
Public body sphere	<i>Such as Municipal or Provincial</i>	Provincial
Reporting public body that is the project owner (and will report on the project)	<i>Which Department approved the project in (education, Health etc.)</i>	KZN Department of Transport
Department / Unit in the Public body that is responsible for the project	<i>Which Department budgeted for the project e.g. Education, Health Directorate</i>	KZN Department of Transport
Implementing public body type	<i>Example(Local Municipality, Distr. Mun or Provincial Dept.</i>	Provincial
Public body that will implement the project	<i>Infrastructure, Environment or Social</i>	KZN Department of Transport
Is this project on the Municipal IDP	<i>Municipal projects</i>	N/A
IDP reference number allocated to the project		N/A

EPWP Details		
EPWP Sector	<i>The project is implemented in which sector? (Infrastructure, Environment & culture, Non-state or Social)</i>	Infrastructure
EPWP programme	<i>The project is implemented under which programme?</i>	
EPWP Sub Programme	<i>The project is implemented under which sub-programme?</i>	
Budget Amount-(Allocations for the project duration)		
Funding Body	<i>Which Dept. is funding the project</i>	KZN Department of Transport
Funding Year	<i>Financial year/s for the project</i>	
Total Budget Amount	<i>(Exclude Professional Fees)</i>	
Incentive Grant(e.g. landcare / EPWP grant)	<i>Grant funding received</i>	
Total wages paid for the duration of the projects	<i>What amount will be spent on wages during the duration of the project</i>	
Wage Rate	<i>Daily Wage rate to be paid during productive work</i>	
Stipend Rate	<i>Daily wage rate to be paid during training</i>	
UIF	<i>The amount being paid to UIF (if applicable)</i>	
COIDA	<i>The amount being paid to COIDA(if applicable)</i>	
Training	<i>What amount will be spent on training</i>	
Administration	<i>The Administration costs</i>	
Equipment and materials	<i>Budget for Materials and Equipment</i>	
Other	<i>If other where chosen describe the other Such as Professional fees)</i>	
Describe other		
Project Outputs and Training		
Planned Primary Output	<i>eg walkways, gabions, kerb * channel, km of road constructed</i>	
Description of Planned Primary Output	<i>Describe the project output (end product and not the milestone) (e.g. kms of tar road constructed) Start with the unit of measure such as number of, kms, ha, sqms etc</i>	
Unit of measure of primary output	<i>Eg. m, m², m³, km, no, ha etc</i>	
Planned primary output quantity	<i>Specify the quantity of output planned</i>	
Number of persons to be trained	<i>How many persons are targeted for on job training</i>	

Contact person		
Title	Person responsible for the Project in the Public Body (Project Manager)	
Initials		
First Name		
Surname		
Email		
Tel (Office)		
Fax Number		
Cell Number		
Physical Address 1		
Physical Address 2		
Physical Address 3		
Physical Address 4		
Postal Address 1		
Postal Address 2		
Postal Address 3		
Postal Address 4		
Position of person		

Participant's personal details												Grants	Experience/ Literacy		Location Details		Nationality	Household Details			Quality Check						
No	First Name as per ID document	Initials	Surname	ID number	Disability (Y/N)	Education Level	Start Date	End Date	Language ID	Address	Cell Number	Government Grant (Y/N) and Type	Other Language 1	Other Language 2	District Municipality	Local Municipality	Nationality (RSA/ Non- RSA)	Number of people in	Number of Dependants in Household	Number of Children attending school	Picture Clear	Text clear	Certification within 3 months of employment	Clear certification	Commissioner details clear		

Department of Transport

EPWP Monthly Progress Form		
Field requested	Description if needed	Please complete the sections in white
Project Details		
Profile ID	full description of what is happening in the project (as per the appointment letter) and the community benefiting from the project	
Project Name	The name of the project	
Project Reference Number	Contract number	
Project description	Full description of what is happening in the project (as per the appointment letter) and the community benefiting from the project	
Month		
Reporting Month		April
Budget Expenditure		
Cumulative Expenditure Amount	What is the Overall amount spend on this project?	
Current Expenditure Amount	What is the amount spend including all grants for this month?	
Wages	How much paid on wages for this month only?	
UIF	How much paid on UIF for this month only?	
COIDA	How much paid on COIDA for this month only?	
Stipends for training	Amount paid to participants whilst on training (this month only)	
Amount spent on service providers for training	How much paid to service providers for training for this month only?	
Training	Total Cost of training for this month? (number captured on ERS)	
Administration	How much paid on administration for this month only?	
Equipment and materials	How much paid on equipment and materials for this month only?	
Other	How much paid on other?	
Describe other	Be specific e.g. Consulting fees, Transport etc.	
Project output description	Describe the project output (end product and not the milestone) (e.g. kms of tar road constructed) Start with the unit of measure such as number of, kms, ha, sqms etc	
Unit of measure of primary output	Eg. m, m ² , m ³ , km, no, ha etc	
Cumulative primary output achieved	Since the onset of the project	
Quantity Achieved	enter numeric output for this month only	
Percentage achieved	How much work done / achieved in percentages?	
EPWP Branding		
Branding compliant	Yes / No	
Date that the branding was provided	When was the project branded?	
Has a photo of project branding been provided?	Yes / No	
First name of Official Who Branded Project	Official Name	
Surname of Official Who Branded Project	Official Surname	
Phone number of official who erected branding for the project	Official contact number	
Give the public body reference and name, and organisational details of the person that provided branding.	Public body details (reference & name)	

First Name	Initials	Surname	ID number	Date Of Birth	Wage Rate	Total Paid Days	Amount Paid	Work Days	Training Days Paid	Training Days Non Paid	Total Training Days	Training Course ID	Project Profile ID	Month	Year	Beneficiary Code



EXPANDED PUBLIC WORKS PROGRAMME

The Attendance Register for on-site Workers

Reporting month: _____

Mobile No: _____

Project Name: _____

Contract no: _____

Surname: _____

First Name: _____

IDENTITY NUMBER:

--	--	--	--	--	--	--	--	--	--	--	--	--	--	--	--	--	--	--	--

Day	Date	Time In	Signature	Time Out	Signature	Report On Any Formal Training Provided In The Reporting Month
WEEK 1						
MONDAY						
TUESDAY						
WEDNESDAY						
THURSDAY						
FRIDAY						
WEEK 2						
MONDAY						
TUESDAY						
WEDNESDAY						
THURSDAY						
FRIDAY						
WEEK 3						
MONDAY						
TUESDAY						
WEDNESDAY						
THURSDAY						
FRIDAY						
WEEK 4						
MONDAY						
TUESDAY						
WEDNESDAY						
THURSDAY						
FRIDAY						
WEEK 5						
MONDAY						
TUESDAY						
WEDNESDAY						
THURSDAY						
FRIDAY						
Total Days worked						

C3.3 PARTICULAR SPECIFICATIONS

PART F: SMALL CONTRACTOR DEVELOPMENT

PART F: SMALL CONTRACTOR DEVELOPMENT

F1. SCOPE

This part provides the procedures that relate to the Contractor implementing the CIDB B.U.I.L.D standard for Indirect Targeting for Enterprise Development through construction Works Contracts, the Employer's policies and initiatives, enabling the Employer to realise its social and development objectives through the participation of Targeted Enterprises and Labour in the construction of the Works. The approach adopted enables the delivery of a wide range of social and economic deliverables, including the employment of local resources, employment opportunities for labour enhanced works, business opportunities, enterprise support and development programmes, and skills development.

The participation of Targeted Enterprises and Labour, measured in monetary terms, is specified as a contract participation goal by the Employer, for the Contractor to achieve.

The Contractor shall:

- Subcontract a minimum of 30% of the scope of works to targeted enterprises
- Perform needs analysis on the targeted enterprise to identify developmental goals;
- Provide internal mentorship support to improve the targeted enterprise/s performance;
- Develop a project specific enterprise development plan to improve the targeted enterprise/s performance in the identified developmental areas to the CIDB Competence Standard for Contractors Gazette No. 41237, 10 November 2017
- Monitor and report the progress of the agreed development areas with the targeted enterprise/s
- Submit a project completion report to the Employer's representative for each targeted enterprise.

F2. DEFINITIONS

Unless inconsistent with the context, in these specifications the following terms, words or expressions shall have the meanings hereby assigned to them:

F2.1 **"Black People"** has the meaning assigned to it in section 1 of the Broad-Based Black Economic Empowerment Act, 2003 (Act No 53 of 2003), and the Broad-Based Black Economic Empowerment Amended Act, 2013 (Act No 46 of 2013).

F2.2 **"Contract Participation"** means a process whereby the Employer sets a target to achieve its social and development objectives through the participation of Targeted Enterprises and Labour in the construction of the Works.

F2.3 **"Contract Participation Goal (CPG)"** means the value of goods, services and works for which the Contractor contracts Targeted Enterprises and Labour exclusive of any value added tax which the law requires the Employer to pay to the Contractor, expressed as a percentage of the Contract Price (adjusted to exclude penalties and value added tax).

F2.4 **"EME"** means an exempted micro enterprise in terms of a code of good practice on black economic empowerment issued in terms of section 9(1) of the Broad-Based Black Economic Empowerment Act, 2003 (Act No 53 of 2003).

F2.5 **"Military Veteran"** has the meaning assigned to it in section 1 of the Military Veterans Act, 2011 (Act No 18 of 2011).

F2.6 **"people with disabilities"** has the meaning assigned to it in section 1 of the Employment Equity Act, 1998 (Act No 55 of 1998).

F2.7 **"Project Management Team (PMT)"** means a team established at the commencement of the contract, comprising a representative from each of the Employer, the Employer's Agent and the Contractor, that will be responsible for various functions related to the implementation of the Contract Participation process.

F2.8 “QSE” means a qualifying small enterprise in terms of a code of good practice on black economic empowerment issued in terms of section 9(1) of the Broad-Based Black Economic Empowerment Act, 2003 (Act No 53 of 2003).

F2.9 “Target Area” means the geographic area stated in the Contract Data.

F2.10 “Targeted Enterprise” means an entity to which the Contractor subcontracts a percentage of the contract value as a condition of contract and which is:

- (i) an EME or QSE which is at least 51% owned by black people;
- (ii) an EME or QSE which is at least 51% owned by black people who are youth;
- (iii) an EME or QSE which is at least 51% owned by black people who are women;
- (iv) an EME or QSE which is at least 51% owned by black people with disabilities; or
- (v) an EME or QSE which is at least 51% owned by black people who are military veterans.

F2.11 “Targeted Labour” means individuals, employed by the Contractor and subcontractors in the performance of the contract, who permanently reside in the target area or who are recognised as being residents of the target area on the basis of identification and association with and recognition by the residents of the target area, and excludes any labour employed by suppliers and manufacturers.

F2.12 “Youth” means persons between the ages of 18 and 35.

F3. CONTRACT PARTICIPATION

F3.1 Objective

In order for the Employer to realise its social and development objectives, the Contractor is required to provide business and labour opportunities through the participation of Targeted Enterprises and Labour in the construction of the Works. The participation of Targeted Enterprises and Labour, measured in monetary terms, is specified by the Employer as a contract participation goal, for the Contractor to achieve.

F3.2 Contract Participation process

The Contractor shall engage Targeted Enterprises and Labour in the performance of the contract to the extent that the total monetary value of such engagements exclusive of any value added tax, expressed as a percentage of the Contract Price (adjusted to exclude penalties and value added tax), is not less than the Contract Participation Goal specified in the contract.

F3.2.1 Contract Participation plan

The Contractor shall submit to the Employer’s Agent details of his plan to achieve the Contract Participation Goal with his initial programme in terms of which he will carry out the Works. The Contract Participation plan shall be submitted with all subsequent adjusted programmes. The tender process for the procurement of Targeted Enterprise subcontractors shall be indicated on the programme.

The Contract Participation plan shall indicate the expected delivery dates of goods provided by Targeted Enterprises, and the commencement and completion dates of work and services to be performed by all the Targeted Enterprises and Labour engaged on the contract for the purpose of securing credits towards the Contract Participation Goal.

The information contained in the Contract Participation plan facilitates, in the first instance, the monitoring by the Employer’s Agent of the performance of the Contractor in terms of his Contract Participation Goal obligations and, in the second instance, the making of any adjustments by the Contractor to compensate for quantitative underruns, the elimination of items contracted to Targeted Enterprises or Labour, or any other reason beyond the Contractor’s control which may be acceptable to the Employer

F3.2.2 Targeted Enterprises

The Contractor shall engage Targeted Enterprises comprising subcontractors and suppliers directly or indirectly in the performance of the contract. Prior to such Targeted Enterprises being engaged, the Contractor shall submit to the Employer's Agent documentation in a form approved by the Employer's Agent, to confirm that the enterprise satisfies the eligibility criteria for recognition as a targeted enterprise.

The Contractor shall enter into written contractual agreements with all the Targeted Enterprises, in a form approved by the Employer's Agent. Copies of such agreements and the written acceptance thereof shall be submitted to the Employer's Agent.

In the case of Targeted Enterprise subcontractors, only those subcontractors procured through a tender process as specified in clause G6 Tender Process for Targeted Enterprise Subcontractor Procurement, shall qualify to have their contribution count towards the Contract Participation Goal.

The Contractor may not subcontract more than 25% of the Contract Price to Targeted Enterprises whose B-BBEE status level of contributor is lower than the Contractor's.

F3.2.3 Targeted Labour

The Contractor shall engage Targeted Labour directly or indirectly in the performance of the contract. It is a requirement of the contract that such Targeted Labour be engaged by means of a written contract, in a form approved by the Employer's Agent.

The requirements for the engagement of such Targeted Labour is contained in Part E: Expanded Public Works Programme.

F3.3 Contract Participation Goal

The Contract Participation Goal comprises two targets, namely subcontracting of the Works to Targeted Enterprises, and employment of Targeted Labour. The Contract Participation Goal targets are stated as a percentage unit of measure in the Contract Data, for the Contractor to achieve to the extent that the total monetary value of such subcontracting and employment engagements exclusive of any value added tax, expressed as a percentage of the Contract Price (adjusted to exclude penalties and value added tax), are each not less than the respective Contract Participation Goal target stated in the contract.

F3.3.1 Monthly submission of supporting documentation

The Contractor shall prepare and submit on a monthly basis to the Employer's Agent in a form approved by the Employer's Agent, the following:

- (i) a brief report which describes the commercially useful functions performed by the Targeted Enterprises and Labour in the performance of the contract, both during the interim period and on a cumulative basis;
- (ii) a schedule reflecting the estimated total value of the contracts, the cumulative value of the contracts, and the value of goods provided, and work and services performed over the period for which payment is claimed with respect to each and every Targeted Enterprise; and
- (iii) a schedule which lists the names, identity numbers, gender, trade/occupation, period of employment, employment number and the like, as directed by the Employer's Agent, together with the respective wage rates payable in respect of Targeted Labour, including the monetary value of wages paid both on a cumulative basis and over the period for which payment is claimed.
- (iv) Project interim reports in the specified format (ED105P) detailing interim value of the CPG that was achieved. Such a report shall also contain a monthly progress report, compiled by the employer's representative and the contractor, detailing an assessment of the enterprise development support provided.

- (v) Project completion report, in the specified format (ED101P), to the Employer's Representative for acceptance within 15 days of achieving practical completion. The report shall include the value of the CPG that was certified in accordance with the contract, cidb registration numbers of each and every targeted enterprise and the value of the subcontracted works or the participation parameter of the joint venture entered into; and
- (vi) Enterprise development declaration (ED104P).

Should random inspections conducted by the Employer's Agent on Targeted Enterprise and Labour activities indicate that such Targeted Enterprises and Labour are not performing in accordance with the requirements of the contract, the Contractor shall provide, in addition to the monthly reporting requirements, separate weekly resource returns and any other relevant information with respect to such Targeted Enterprises and Labour in a form approved by the Employer's Agent.

F3.3.2 Contract Participation Goal credits

F3.3.2.1 Granting of credits

The Employer's Agent shall certify the value of the credits counted towards the Contract Participation Goal whenever a claim for payment is issued to the Employer, and shall notify the Contractor of the amount. The value of the credits counted shall not include any expenditure on Goods and Labour which forms part of the monetary value of the contributions made by Targeted Enterprise subcontractors.

Credits towards the Contract Participation Goal shall be granted by converting the value of the following (including contract price adjustment and rise/fall on special materials, but excluding value added tax) to a percentage of the Contract Price (adjusted to exclude penalties and value added tax), as relevant:

- (i) subcontracting CPG:
 - the total monetary value of the contributions made by Targeted Enterprise subcontractors in fulfilling contractual obligations; and
 - expenditure on Goods required for the contract, which are obtained from Targeted Enterprise suppliers.
- (ii) employment CPG:
 - the total monetary value of wages paid to Targeted Labour.

F3.3.2.2 Denial of credits

No credits shall be granted should the Contractor make a direct payment to a supplier or manufacturer on behalf of a Targeted Enterprise when such payment is recovered by making deductions from payments to the Targeted Enterprise in connection with the contract; or should the Contractor fail to enter into a written agreement with the relevant Targeted Enterprise.

In addition, credits claimed towards the Contract Participation Goal shall be denied where written contractual agreements contain any of the following:

- (i) a right to set off in favour of the employing Contractor not provided for by law;
- (ii) authoritarian rights given to the employing Contractor or his agent, with no recourse to independent adjudication in the event of a dispute arising;
- (iii) payment procedures based on a pay-when-paid system;
- (iv) a dispute resolution process which does not include inexpensive alternative dispute resolution procedures, such as mediation or adjudication, but which only makes use of formal proceedings such as arbitration or litigation; or
- (v) conditions which are more onerous than those which exist in the main contract.

Credits shall be denied should Targeted Enterprises not adhere to statutory labour practices or fail to perform commercially useful functions.

F3.3.3 Contract Participation Goal evaluation

The Contractor shall, upon completion of each individual Targeted Enterprise's contract, issue a completion certificate and certify the amount paid to such Targeted Enterprises. The Contractor shall submit the certificates, counter-certified by the relevant Targeted Enterprises, to the Employer's Agent for record-keeping purposes. The Contractor shall furnish justification to the Employer's Agent whenever it is not possible to obtain such counter-certification.

The Contractor shall, upon termination of the services of the individuals classed as Targeted Labour engaged in activities relating to the performance of the contract, certify the amount paid to such individuals and submit the certificate, counter-certified by the relevant individual, to the Employer's Agent for record-keeping purposes. The Contractor shall furnish justification to the Employer's Agent whenever it is not possible to obtain such counter-certification.

On completion of the contract, the Employer's Agent shall determine the final credits to be granted towards the Contract Participation Goal targets, by converting the value of credits (including contract price adjustment and rise/fall on special materials, but excluding value added tax) to a percentage of the Contract Price (adjusted to exclude penalties and value added tax)

F3.3.4 Sanctions

In the event that the Contractor fails to substantiate that any failure to achieve any of the Contract Participation Goal targets, is due to quantitative underruns, the elimination of items contracted to Targeted Enterprises, or any other reason beyond the Contractor's control which may be acceptable to the Employer, the Contractor shall be liable for a financial penalty as prescribed in clause SCC 4.1.1 of section C1.2.1.2 Special Conditions of Contract. The subcontracting financial penalty shall be calculated as follows:

$$P = 0,05 \times [(D - D_0)/100] \times C_A$$

where

D is the Contract Participation Goal percentage

D₀ is the Contract Participation Goal percentage which the Employer's Agent certifies, based on the credits passed, as being achieved upon completion of the contract

C_A contract amount which is the Contract Price (adjusted to exclude penalties and value added tax)

P is the monetary value of penalty payable

The evaluation of the Contractor's achievement of the Contract Participation Goal for the subcontracting of the Works to Targeted Enterprises, shall be undertaken monthly by the Employer's Agent based on the accumulative achievements in comparison to the programmed utilisation of Targeted Enterprises, as a means of monitoring the Contractor's performance in achieving the Contract Participation Goal.

Failure by the Contractor to achieve the Contract Participation Goal target by the time of Practical Completion, shall result in the financial penalty being applied as prescribed in this clause. The Employer's Agent shall make a final determination of the Contractor's achievement of the Contract Participation Goals based on the value of the Final Payment Certificate.

F4. DUTIES OF THE EMPLOYER AND ENGINEER

The Employer, Engineer, and the Contractor, or their representatives, are parties to the Project Liaison Committee and are co-responsible for successful project Stakeholder and Community liaison. The Employer and the Engineer also play a supporting role in the successful implementation of the Employer's Targeted Labour and Targeted Enterprise utilisation and development goals.

To implement the Employer's Targeted Labour and Targeted Enterprise goals, the Employer and the Engineer shall provide support to the Contractor by executing the following duties:

- (i) Make recommendations to the Contractor in the identification and structuring of the work packages to be subcontracted to Targeted Enterprises, and agree to the scope and extent of the work packages.
- (ii) Verify that the Targeted Enterprise Database(s), have been updated prior to the letting of every new set of subcontracts.
- (iii) Endorse all Databases, and approve tender procedures, tender documents, tender submission requirements and adjudication processes for the subcontracting of Targeted Enterprises.
- (iv) Review all tender adjudication reports and monitor that the criteria and procedures applied by the Contractor to subcontract work to Targeted Enterprises are executed in a fair and transparent manner, and are in accordance with the Employer's standards.
- (v) Endorse subcontract agreements and ensure that the conditions of subcontracting with Targeted Enterprises are fair and transparent and within the prescripts of the Contract requirements.
- (vi) Monitor the management of Targeted Enterprise subcontracts and ensure that conditions such as the application of penalties and the termination of contracts, are applied in a fair and transparent manner and within the prescripts of the agreement.
- (vii) Verify that the Labour Database(s) from which Targeted Labour will be employed is updated prior to every new Labour intake.
- (viii) Monitor that the criteria and procedures applied by the Contractor to employ Targeted Labour are executed in a fair and transparent manner, and is within the Contract requirements.
- (ix) Monitor that the conditions of employment of Targeted Labour are applied in a fair and transparent manner and within the prescripts of the current and relevant Labour legislation.
- (x) Make recommendations to the Contractor in the identification of the training requirements of Targeted Enterprises and Targeted Labour and approve the proposed training programmes.
- (xi) Monitor that training programmes and support programmes, which the Contractor committed to, are implemented and executed as intended.

F5. SPECIFIC WORK TO BE CARRIED OUT BY TARGETED ENTERPRISE SUBCONTRACTORS

F5.1 Subcontract scope of work

It is a requirement of the contract that only those Targeted Enterprise subcontractors procured through a tender process by the Contractor, shall qualify to have their contribution count towards the Contract Participation Goal.

For this particular contract, the following listed work has been identified in terms of this Particular Specification, Part G, as suitable for execution by Targeted Enterprise subcontractors in order to assist the Contractor in achieving the Contract Participation Goal:

- (i) Culverts
- (ii) Roadbed Construction.
- (iii) Standard crack sealing
- (iv) Patching and edge break repair

- (v) Pitching, stonework and cast in situ concrete for protection against erosion.
- (vi) Construction of gabions.
- (vii) Erection of guardrails.
- (viii) Erection of road signs.
- (ix) Guide Blocks and Kilometre Markers.
- (x) Landscaping.
- (xi) Construction of gabions
- (xii) Erection of handrails
- (xiii) Other work identified by the Employer to be executed in the community area.

The work to be carried out by Targeted Enterprise subcontractors is not limited to the work listed above, and the Contractor may need to engage Targeted Enterprises and Labour on other aspects of the Works in order to achieve the Contract Participation Goal.

G5.2 Subcontract work packages

The work activities shall be grouped into varying sizes of work packages according to the CIDB contractor grading designation and class of construction works. The typical scope of work may include the following class of construction works and specialist works:

- (i) Class of construction works – Civil Engineering (CE); and
- (ii) Specialist Works:
 - Asphalt works (SB);
 - Road marking and signage (SK)
 - Landscaping (SH)
 - Structural steelwork fabrication and erection (SL); and
 - Demolition and blasting (SE)

For this contract the minimum number of prescribed work packages for execution by Targeted Enterprise subcontractors is indicated in table F1/1 according to the CIDB contractor grading designation and the scope of work according to the Chapters of the Standard Specifications for Road and Bridge Works for South African Road Authorities (COTO), Draft Standard (DS), October 2020.

Provision is made for each of the work packages to include Chapter 1.3 Contractor's Establishment on Site and General Obligations to cover the costs of the Targeted Enterprise subcontractors' own establishment and general obligations.

TABLE F1/1: PRESCRIBED MINIMUM NUMBER OF WORK PACKAGES ACCORDING TO CIDB CONTRACTOR GRADING DESIGNATION							
CHAPTER	DESCRIPTION	TARGETED ENTERPRISE SUBCONTRACTOR CIDB CONTRACTOR GRADING DESIGNATION					
		1 Max: R0,5 m	2 Max: R1 m	3 Max: R3 m	4 Max: R6 m	5 Max: R10 m	6 Max: R20 m
C1.5	ACCOMMODATION OF TRAFFIC		X(1)	X(1)			
C1.6	CLEARING AND GRUBBING	X(1)					
C3.1	DRAINS	X(1)					
C3.2	CULVERTS		X(1)				
C3.3	CONCRETE KERBING AND CHANNELING, ASPHALT BERMS, CHUTES, DOWNPIPES, AS WELL AS CONCRETE, STONE PITCHED AND GABION LININGS FOR OPEN DRAINS	X(1)					
C8.1	PRIME COAT	X(1)					
C8.4	RUT AND/OR DEPRESSION CORRECTION	X(1)					
C8.5	STANDARD CRACK SEALING	X(1)					
C8.8	PATCHING AND EDGE BREAK REPAIR	X(1)					
C9.1	ASPHALT LAYERS	X(1)					
C11.1	PITCHING, STONEMWORK, CAST IN SITU CONCRETE FOR PROTECTION AGAINST EROSION	X(1)					
C11.2	NON-STRUCTURAL GABIONS		X(1)				
C11.3	GUIDE BLOCKS AND KILOMETRE MARKERS	X(1)					
C11.4	ROAD RESTRAINT SYSTEMS		X(1)				
C11.6	ROAD SIGNS	X(1)					
C11.7	ROAD MARKING AND ROAD STUDS		X(1)				
C11.8	LANDSCAPING AND PLANTING PLANTS			X(1)			
C12.6	MECHANICALLY STABILISED EARTH AND GABIONS		X(1)				
C14.9	REPAIR AND REPLACEMENT OF ANCILLARY STRUCTURAL ELEMENTS	X(1)					
	MINIMUM TOTAL NUMBER OF TARGETED ENTERPRISE SUBCONTRACTORS <u>PRESCRIBED</u> FOR EACH CIDB CONTRACTOR GRADING DESIGNATION	12	6	2	0	0	0

NOTE:

All work packages must include Chapter 1.3

X(1) denotes "one" prescribed subcontract work package according to the respective CIDB contractor grading designation and the scope of work according to the Chapter of the Standard Specifications for Road and Bridge Works for South African Road Authorities (COTO), Draft Standard (DS), October 2020.

For subcontractors with a higher CIDB contractor grading designation, it may be possible for the work package to comprise more than one chapter which is shown as "X" in the above table. The minimum total number of targeted enterprise subcontractors prescribed for each CIDB contractor grading designation is listed in the above table.

F5.3 Subcontract bill of quantities

The items of work identified for execution by Targeted Enterprise subcontractors is shown in the bill of quantities at the end of Part G: Small Contractor Development. The quantities of work shown for each item of work, is the anticipated work to be subcontracted, and the Contractor is not required to tender rates and prices for these items of work.

Payment of the works executed by Targeted Enterprise subcontractors will be made under the provisional sum allowed for in clause G10 Measurement and Payment and included in Schedule F: Small Contractor Development in Section C2.2 Bill of Quantities.

F6. TENDER PROCESS FOR TARGETED ENTERPRISE SUBCONTRACTOR PROCUREMENT

F6.1 Subcontract scope of work

The Contractor shall refer to Table F1/1 for the work packages identified to be subcontracted, the bill of quantities contained in these Particular Specifications, and to any other construction activities required to execute the Works in terms of the contract, to determine how he intends to unbundle or package specific subcontracts for execution by Targeted Enterprise subcontractors, and shall present his proposal to the Employer and Employer's Agent for approval.

F6.2 Compilation of subcontract tenders

The Contractor shall be responsible for compiling the tender documents that will enable him to engage the Targeted Enterprise subcontractors for the various work packages, according to the contractor grading designation and class of construction works or specialist works. The Contractor shall compile each subcontract tender document in such a manner that it shall facilitate the achievement of all objectives and principles pertaining to the development of the Targeted Enterprise subcontractors.

The tender documentation shall comply with the Employer's standards, including its standard conditions of tender. The following returnable schedules shall form part of the tender document for submission by tenderers:

- (i) certificate of registration of the tenderer in the required CIDB contractor grading designation, confirming the tenderer's registration Status as "Active" at the closing date of tender submission;
- (ii) tax compliance status report;
- (iii) B-BBEE verification certificate or sworn affidavit;
- (iv) proof of registration on the Central Supplier Database; and
- (v) compliance with the COID Act.

The tender documents shall also contain the proposed subcontract agreement in accordance with clause G8.1.

The draft tender documents shall be subject to approval by the Employer and Employer's Agent. The Contractor may then proceed with the preparation of tender documents for the work packages.

F6.3 Tender process

The Contractor shall be responsible for advertising the tenders for the work packages, and inviting tenders from Targeted Enterprise subcontractors in consultation with the Employer and Employer's Agent and the local PLC.

The Employer shall identify the number of work packages which are to be executed by Targeted Enterprise subcontractors from specific designated groups.

The Contractor shall conduct a compulsory briefing session for tenderers, attended by the Employer and Employer's Agent, to explain the Works required and the tender process to the Targeted Enterprise

subcontractors.

Tenders for the subcontracted works must close at a stipulated time and date. Tenders shall be placed in a suitable formal Tender Box, located at the Contractor's site office. The tender opening shall be conducted by the Project Management Team.

F6.4 Tender evaluation

The Project Management Team shall evaluate the tenders according to the Employer's standards. The Contractor shall prepare the tender adjudication report for each subcontract, and submit it to the Project Management Team for review prior to award of each subcontract.

F6.5 Allocation of subcontract work packages

The Project Management Team shall identify responsive tenders received for the various work packages from Targeted Enterprises in the following designated groups:

- (i) an EME or QSE which is at least 51% owned by black people;
- (ii) an EME or QSE which is at least 51% owned by black people who are youth;
- (iii) an EME or QSE which is at least 51% owned by black people who are women;
- (iv) an EME or QSE which is at least 51% owned by black people with disabilities; or
- (v) an EME or QSE which is at least 51% owned by black people who are military veterans.

The selection of subcontract work packages shall then be made, in consultation with the Employer in accordance with the provisions of clause 4.4.4 of the General Conditions of Contract 2015, in order to comply with the Employer's targeted procurement objectives.

F6.6 Award of subcontract work packages

Following the selection of the Targeted Enterprise subcontractors for the various work packages in consultation with the Employer in accordance with clause 4.4.4 of the General Conditions of Contract 2015, the Employer's Agent shall provide written confirmation of the Targeted Enterprise subcontractor selected for each work package, to the Contractor. The Contractor shall award each work package to the respective Targeted Enterprise subcontractor.

F7. GENERAL RESPONSIBILITIES OF THE CONTRACTOR TOWARDS TARGETED ENTERPRISES

F7.1 Obligations

The Contractor shall ensure that he complies with the following obligations:

- (i) institute a quality assurance system;
- (ii) provide adequate training, coaching, guidance, mentoring and assistance to Targeted Enterprises;
- (iii) provide financial support and other assistance to ensure that Targeted Enterprises are able to meet their obligations and commitments with respect to their subcontracts, including acquisition of labour, construction equipment and materials;
- (iv) ensure that the contract participation goals and objectives are achieved; and
- (v) make provision for Targeted Enterprises to be established within the Contractor's own camp facilities, and be responsible for the provision of site offices, common camp facilities, medical, security, safety, electricity, water, sewage services, waste disposal and all other camp services.

- (vi) be responsible for developing subcontractors in accordance with the cidb Standard for Indirect Targeting for Enterprise Development.
- (vii) be responsible for the appointment of the Enterprise Development Coordinator.

F7.2 Subcontracts

In the subcontracts arranged by the Contractor involving Targeted Enterprises, the following shall apply:

- (i) the appointment of Targeted Enterprises by the Contractor shall be made in accordance with the provisions of clause 4.4 of the General Conditions of Contract 2015; and
- (ii) no provision or requirements set out in the specifications shall be deemed to relieve the Contractor of any liability or obligation under the contract, and in accordance with the provisions of clause 4.4.3 of the General Conditions of Contract 2015, the Contractor shall be liable for the acts, defaults and negligence of any Targeted Enterprise, his agents or employees as fully as if they were the acts, defaults or negligence of the Contractor.

F8. MANAGEMENT OF TARGETED ENTERPRISE SUBCONTRACTS

The Contractor shall conclude the subcontract agreements, and provide the necessary management support to the Targeted Enterprises. Failure by a Targeted Enterprise to comply with the terms and conditions of the subcontract agreement shall result in penalties being applied or the subcontract terminated.

F8.1 Compilation of subcontract conclusion agreement

- (a) The Contractor in liaison with the Employer and Employer's Agent shall be responsible for the conclusion of each subcontract agreement. The agreement shall be in accordance with the provisions of clause 4.4 of the General Conditions of Contract 2015 and shall be consistent with the terms and conditions in this contract. The agreement shall be subject to approval by the Employer and Employer's Agent.
- (b) The terms and conditions of the subcontract agreement shall also specify the following:
 - (i) an entitlement of the Targeted Enterprise to receive such training as is contemplated in this contract;
 - (ii) an obligation on the Targeted Enterprise to participate and co-operate in such training as is provided for in this contract;
 - (iii) the allowable sources from which workers may be drawn in terms of the contract;
 - (iv) the terms and conditions relating to the recruitment, employment and remuneration of workers engaged on the contract;
 - (v) the training to be provided to the workers; and
 - (vi) the terms and conditions relating to payment of the Targeted Enterprise. Such terms and conditions shall also include a clause stipulating that payment to a Targeted Enterprise for work done shall be made within 30 days of submission of the invoice by the Targeted Enterprise to the Contractor. In the event of failure by the Contractor to make the payment by the due date, he shall pay to the Targeted Enterprise interest, at the prime overdraft rate charged by the Targeted Enterprise's bank, compounded monthly, on all overdue payments from the date on which the same should have been paid to the date when payment is effected, without prejudice to the Targeted Enterprise's other rights under the contract or by law.

F8.2 Quality of work and performance of the Targeted Enterprise

- (a) The Contractor shall closely monitor and supervise all Targeted Enterprises and shall train, mentor, guide and assist each Targeted Enterprise in all aspects of management, execution and completion of his subcontract. This shall typically include assistance with planning of the works, sourcing and ordering of materials, labour relations, monthly measurements and invoicing procedures. The extent and level of such training, mentoring, guidance and assistance to be provided by the Contractor shall

be commensurate with the basic level of subcontract applicable and shall be directed at enabling the Targeted Enterprise to achieve the successful execution and completion of their subcontract.

- (b) The Contractor shall closely monitor and supervise all Targeted Enterprises and shall give reasonable warning to the Targeted Enterprise when any contravention of the terms and conditions of the subcontract has occurred or appears likely to occur. The Contractor shall, whenever feasible, give the Targeted Enterprise reasonable opportunity to make good any such contravention, or to avoid such contravention, and shall render all reasonable assistance to the Targeted Enterprise in this regard.

F8.3 Dispute avoidance and resolution procedures

- (a) When taking any disciplinary action or imposing a penalty as provided for in the subcontract, the Contractor shall explain fully to the Targeted Enterprise that such actions are provided for in the subcontract. If such action is contemplated this shall be discussed with the Employer's Agent before any action is taken.
- (b) If the Targeted Enterprise, in the opinion of the Employer's Agent, fails to comply with any of the criteria listed below, the Employer's Agent shall issue a written warning to the Contractor, stating all the areas of non-compliance. A copy of the letter of warning shall be forwarded to the Employer. The criteria are as follows:
- (i) acceptable standard of work as set out in the specifications;
 - (ii) progress in accordance with the time constraints in the Targeted Enterprise's contract;
 - (iii) punctual and full payment of the workforce and suppliers;
 - (iv) site safety; and
 - (v) accommodation of traffic.
- (c) The Targeted Enterprise shall have 21 days from the date of receipt of the letter of warning by the Contractor to address and rectify the issues raised by the Employer's Agent, with the exception of the above subclauses (b)(iv) and (v) for which the reaction time shall be in accordance with the relevant specifications for those aspects of the Works but shall not be longer than 24 hours. Failure by the Targeted Enterprise to comply with the deadline set, will be sufficient grounds for the Contractor to apply a penalty, or terminate the subcontract provided that the Employer's Agent is satisfied that the Contractor has made every effort to correct the performance of the Targeted Enterprise.
- (d) The Targeted Enterprise shall have the right to dispute any ruling given or deemed to have been given by the Contractor, Employer's Agent or Employer. Provided that, unless the Targeted Enterprise shall, within 21 days after his receipt of a ruling or after a ruling shall have been deemed to be have been given, give written notice (hereinafter referred to as a Dispute Notice) to the Contractor, referring to this clause, disputing the validity or correctness of the whole or a specified part of the ruling, he shall have no further right to dispute that ruling or the part thereof not disputed in the said notice.

F9. TRAINING, COACHING, GUIDANCE AND MENTORING

F9.1 Obligations

This section provides details of the Contractor's obligations of implementing the National Skills Development Strategy. This strategy sets priorities for the skills development of workers. The Sector Education and Training Authorities (SETA) and provincial offices of the Department of Labour will play key roles in transforming the vision of the strategy into reality.

Supervision is included as part of the contractor's general obligations for the administration and management of the Targeted Enterprises. However, training, coaching, guidance and mentoring are not included as part of the Contractor's general obligations unless specific provision to that effect has been made in the project specifications.

The Contractor shall, from the commencement of the contract, provide a structured development programme designed to improve the entrepreneurial and basic business management skills of identified Targeted Enterprises and hired labour, as well as to improve their specific task skills (construction skills) commensurate with the applicable levels of subcontract that will enable the Targeted Enterprises to achieve the successful execution and completion of their subcontracts. The ultimate objective of training, coaching, guidance and mentoring is to develop the Targeted Enterprises as far as their potential allows.

F9.2 Definitions

F9.2.1 Training

Training refers to the process of teaching a learner – usually in a classroom or simulated work environment situation. Training usually takes place with one teacher/trainer and several learners. Principles and theory are taught. Demonstrations are given. Assignments are then set to ensure that the learner is able to apply what has been taught. Training is done by a specialist in the subject, who is also qualified to train.

Example: Use of a dumpy level

Training would involve the theory of how a dumpy level works and how to calculate levels. A demonstration of how to set up and read a level could be given.

F9.2.2 Coaching

Coaching refers to hands-on training and is mostly on a one-on-one basis of tangible and measurable skills. It is typically on-site training, or learning-on-the-job. Coaching is training by the process of “watch-do-correct-practice”. The coach does the task while the learner watches and asks questions. Then the learner does the same task while the coach watches. The learner is corrected until the coach feels that he has the gained competence in the function. The learner is then left to practise the task or skill, which the coach oversees. Coaching is imparting a skill – usually manual or physical. A coach is usually a person doing the same type of work on a higher or more competent level, or a person who has a mastery of the skill/task. While training gives the theory or shows/explains the principles, coaching helps the learner become competent and master a skill. A coach is often in the direct reporting line, i.e. someone in authority. Coaching could be part of the management function and would make the job run more smoothly.

Example: Use of a dumpy level

Coaching would involve taking the learner onto site, setting up a dumpy level, reading levels. Then the coach would get the learner to do the job, while the coach checked the setting up and reading. Once the learner understands and can do the tasks, the coach checks periodically to ensure the learner is still doing the job properly.

The desired outcome of coaching is for the learner to “fit-the-mould”, and to do things the same way and to the same standard as the coach.

F9.2.3 Guidance

Guidance is anticipating where one might go wrong, or where one is doing a task in a complicated, inefficient or ineffective way, and giving advice as to how to achieve a better result. Guidance is mostly given by a person in the direct reporting line, but can be given by anyone. Guidance is not imparting skills, but suggesting ways to improve performance.

Example: Use of a dumpy level

A person who knows how to use a dumpy level would be given guidance as to where he would next set up the level to limit the number of set-ups. Guidance could be an extension of coaching.

F9.2.4 Mentoring

Mentoring is developing a person on a long-term career path. It is mostly about imparting skills that are often intangible and non-measurable. A mentor is seldom anyone in the direct reporting line – although he could be a person several levels higher in that reporting line. Mentoring is more about developing a relationship and taking a personal interest in an individual. A mentor looks out for that individual and gives him advice that cannot be found in a book or in the normal course of business. The sort of issues a mentor discusses with the protégé include company politics, how to pick up work before others get wind of it, how to position one's company to get a better competitive advantage, how to tender such that the tender is lowest but the profit is as good as or better than the next person, how to determine and assess risk. Mentoring helps the protégé think strategically, sharpen entrepreneurial skills and grow – both personally and in terms of the company. A mentor helps the protégé to develop insight and shrewdness. It is more about business skills to survive long-term than the technical, tactical or day-to-day activities of doing business.

The desired outcome of mentoring is for the protégé to develop his own style, i.e., to shape his own “mould”.

F9.2.5 Supervision

Supervision is instruction regarding the work to be performed, and ensuring it is carried out to specification and to the satisfaction of the supervisor. It is not instruction on how the work is to be performed, but rather on what work has to be performed, and usually has specific time frames.

F9.3 Assessment of Targeted Enterprise potential

It is the responsibility of the Contractor to determine the level of development required by each Targeted Enterprise. This will require that the Contractor determine the level at which the Targeted Enterprise can operate competently and determine the skills already acquired by the Targeted Enterprise in terms of training and on-the-job experience. In some circumstances Adult Basic Education Training (ABET) will need to be started before any formal training can commence. The assessment of each appointed Targeted Enterprise is to be produced by the Contractor for discussion with the Employer and Employer's Agent at a meeting following the appointment of the Targeted Enterprise.

F9.4 Development Plan

Within a month of the meeting with the Employer and Employer's Agent on the Targeted Enterprise assessments, the Contractor is to present a development plan, specific to each Targeted Enterprise. The development plan is to be reviewed by the Employer and Employer's Agent for appropriateness before being implemented.

The development plan is to include the following:

- (i) specify the development needs of each Targeted Enterprise contracting entity – the systems the entity lacks;
- (ii) specify the development needs of the individuals comprising the entity – the skills the individuals within the entity lack;
- (iii) the level to which that activity will be developed within the period of the contract;
- (iv) whether training, coaching, guidance and/or mentoring is to be given in each activity; and
- (v) the person/s responsible for each activity.

F9.5 Identification and general training of potential Targeted Enterprises

- (a) The progression of training, coaching and mentorship may need to start with the identification and general training of identified Targeted Enterprises and hired labour, and should end with their acquisition of sufficient management skills that will equip them to compete confidently for subcontract work beyond the duration of this contract. In addition, generic skills shall be taught where the need for these has been identified as being necessary amongst Targeted Enterprise workforces and hired labour.
- (b) Before commencing with any structured training, the Contractor shall submit his intended programme to the Employer and Employer's Agent for approval of its subject content and proposed trainers, and

the Contractor shall, if so, instructed by the Employer and Employer's Agent, alter or amend the programme and/or course content.

The Contractor shall be responsible for the provision of everything necessary for the delivery of the various training workshops and modules including:

- (i) provision of a suitable fully serviced training venue facility;
- (ii) procurement of suitable accredited trainers;
- (iii) provision, in conjunction with the accredited trainers, of all the necessary training materials, including stationery and study materials; and
- (iv) transportation of the learners to and from the training venue facility (it is therefore in the Contractor's interest that the training venue facility be provided on the site in order to reduce these transportation costs).

Payment to the Contractor for carrying out the training function shall be effected through the pay items provided in this Part G, using the training facility provided under Part F: Expanded Public Works Programme.

F9.6 Activities

The tasks for each of the activities making up the development plan include material, equipment and general tasks, for training on technical, contractual, financial, human resources, legislative and general administrative functions.

The Construction Manager, site clerk and HR Manager will train/coach or mentor the above listed functions as part of on-site training.

F9.7 Portfolio of Evidence

The Contractor is to develop and/or maintain a portfolio of evidence for each Targeted Enterprise. The Portfolio of Evidence is a collection of proof of the training, coaching, guidance and mentoring inputs provided to the Targeted Enterprise and is similar to a log book used by technical students completing experiential training. It is a living document which records the development progress of the Targeted Enterprise and will need to be updated continually throughout the duration of the contract. It remains the property of the Targeted Enterprise who must take it to their next contract.

The Portfolio of Evidence should include the following documentation:

- (i) the development path designed for each Targeted Enterprise;
- (ii) the training courses completed by the Targeted Enterprise;
- (iii) the hours of guidance, coaching and mentoring received for each activity listed in the development plan;
- (iv) a list of outcomes achieved at each level for each activity;
- (v) six-monthly progress reports on the development provided (inputs) versus the actual progress made (output) by the Targeted Enterprise; and
- (vi) a list of competencies.

F9.8 Training Requirements

Only qualified trainers employed by training agencies that are accredited by the relevant Sector Education and Training Authorities (SETA), or other institutions recognised by the Department of Labour shall deliver any training. "Accredited training" refers to both the trainers as well as to the training material. Certificates affirming the successful participation in the various courses shall be presented to each attendant.

The Contractor shall facilitate in the delivery of training by instructing and motivating the hired labour and relevant Targeted Enterprises regarding attendance and participation. All training shall take place within normal working hours, or as agreed with the trainees.

F9.9 Development training

The Contractor will arrange training to support the development of the Targeted Enterprise. This training must

be provided by training providers accredited with the relevant SETA pertaining to the course material being presented. The training will take place at hours agreed with the trainees, possibly on a part time basis after hours.

The following training courses are recommended to support the development programme detailed in the contract document:

- (i) NQF Level 2: Construction Contractor - Business owner and administration officer;
- (ii) Tender training NQF Level 3 – Business owner / Technical expert;
- (iii) Computer literacy training - Business owner and admin officer – Microsoft Windows, email, Microsoft Word and Microsoft Excel;
- (iv) General bookkeeping relevant to construction - Business owner and admin officer;
- (v) Tendering NQF Level 4 and 5 – Business owner / Technical expert; and
- (vi) Construction supervision (Roadworks) NQF Level 4 – Business owner / Technical expert.

F9.10 Safety Training

The Targeted Enterprise's safety representative is to be fully trained in all aspects of safety and his duties in this regard. The owner of the Targeted Enterprise is to be trained on his responsibilities regarding safety regulations.

F9.11 Construction skills training

The focus of training provided on the contract should be to support the development of the Targeted Enterprise subcontractor. Construction skills training will only be approved by the Employer's Agent when appropriate.

The Targeted Enterprise, their workforce and hired labour that are selected will be entitled to receive structured training that will improve on-task skills necessary for the execution and successful completion of the works. The Contractor, in conjunction with the Employer's Agent, shall monitor the progress of the hired labour and each Targeted Enterprise closely and shall identify those who, in their collective opinion, will benefit from structured construction skills training as may be provided for in the contract, and where required by the Employer's Agent shall make recommendations in this regard. The final list of candidates shall be decided between the Contractor and the Employer's Agent, and those selected shall receive formal construction skills training in a programmed and progressive manner throughout the duration of the contract.

The training programme shall offer complete courses that could comprise some or all of the following modules:

- (i) Use and maintenance of hand tools;
- (ii) Operation of equipment;
- (iii) Manufacture and installation of minor precast concrete units;
- (iv) Erect, dismantle and maintain formwork;
- (v) Basic concrete skills;
- (vi) Excavation, backfill and compaction;
- (vii) Bricklaying; and
- (viii) Erosion protection using stone pitching, gabions or reos.

F9.12 Training venue facility

The training venue facility to be provided by the Contractor is described in clause E5.6 of Part E. This facility shall be used to deliver all training, irrespective of whether it is delivered in terms of Part E or Part F of the Particular Specifications.

F9.13 Enterprise Development Co-ordinator

The contractor shall appoint an Enterprise Development Co-Ordinator who shall:

- a) develop a project specific Enterprise Development plan to improve the targeted enterprise’s performance in the identified developmental areas and shall allocate resources to monitor progress in relation to improved performance; and
- b) shall, submit to the employer’s representative a monthly enterprise development report (Performa – ED105P) which documents all mentoring activities that have taken place during that month and the progress made in improving the targeted enterprise’s performance in the agreed developmental areas, countersigned by the targeted enterprise.

Competence Criteria for an Enterprise Development Co-ordinator

The enterprise development co-ordinator shall have the following competencies:

- 1.1 Minimum experience of 5 years in the construction industry at Managerial level as a Site Agent, Contracts Manager, Site Manager, Construction Manager, Business Development Manager or Enterprise Development Manager.
- 1.2 Minimum experience of 2 years in training and development in Building or Construction; and
- 1.3 National Diploma or B Degree in the Built Environment or Business Management

F10. MEASUREMENT AND PAYMENT

Note:

In order to avoid duplication of training facilities, the training facility required for the training described in this Part F: Small Contractor Development, shall be measured and paid for in terms of the pay items provided for training in Part E: Expanded Public Works Programme.

Item	Unit
F10.01 Procurement of Targeted Enterprises:	
(a) Management and execution of Targeted Enterprise procurement process:	
(i) Procurement process for the appointment of CIDB contractor grading designation 1 Targeted Enterprise subcontractor (100 copies of the tender document required for each individual tender)	number (No)
(ii) Procurement process for the appointment of CIDB contractor grading designation 2 Targeted Enterprise subcontractor (80 copies of the tender document required for each individual tender)	number (No)
(iii) Procurement process for the appointment of CIDB contractor grading designation 3 Targeted Enterprise subcontractor (60 copies of the tender document required for each individual tender)	number (No)
(iv) Procurement process for the appointment of CIDB contractor grading designation 4 Targeted Enterprise subcontractor (50 copies of the tender document required for each individual tender)	number (No)
(v) Procurement process for the appointment of CIDB contractor	

- grading designation 5 Targeted Enterprise subcontractor
(40 copies of the tender document required for each individual
tender) number (No)
- (vi) Procurement process for the appointment of CIDB contractor
grading designation 6 Targeted Enterprise subcontractor
(40 copies of the tender document required for each individual
tender) number (No)

The unit of measurement shall be the number of individual subcontract agreements concluded with Targeted Enterprise subcontractors according to the CIDB contractor grading designation for all classes of construction works, in accordance with the procurement process described in this Part G.

Each tendered rate shall be in full compensation for the management and execution of the Targeted Enterprise procurement process in the relevant CIDB contractor grading designation scheduled, including for the compilation, printing, binding and issue of the tender documents for each tender, for the advertising of each tender, for the provision of the venue and the conducting of each compulsory briefing session for tenderers, for the conducting of each tender opening process, for the adjudication of the tenders received for each tender, for the preparation of each tender adjudication report and the review thereof in conjunction with the Employer and Employer's Agent, for the award of each tender and for the conclusion of the subcontract agreement with each successful Targeted Enterprise subcontractor tenderer.

Item	Unit
F10.02 Construction Works for Targeted Enterprise subcontractors:	
(a) Payments associated with the construction Works carried out by Targeted Enterprise subcontractors	provisional sum (Prov sum)
(b) Handling costs and profit in respect of sub item F10.02(a)	percentage (%)
(c) Supply of materials and small construction equipment to assist Targeted Enterprise subcontractors	provisional sum (Prov sum)
(d) Handling costs and profit in respect of sub item F10.02(c).....	percentage (%)
(e) Management of the Targeted Enterprise subcontractor	
(i) Needs Analysis and Enterprise Development Plan per Targeted Enterprise	Number (No)
(ii) Monitoring and Interim reporting per Targeted Enterprise	Per Quarter
(iii) Project Completion report per Targeted Enterprise	Number (No)
(iv) Skills Development Co-Ordinator.....	(No/month)

Expenditure under sub items F10.02(a) and (c) shall be in accordance with clause 6.6 of the General Conditions of Contract 2015.

The provisional sum for sub item F10.02(a) is provided to cover the total cost of the construction Works carried out by the Targeted Enterprises subcontractors based on proof of payment made by the Contractor, as certified by the Employer's Agent, in separate payments for each Targeted Enterprise subcontractor in accordance with Part G of the Particular Specifications.

The tendered percentage for sub item F10.02(b) is the percentage of the amount actually spent under sub item F10.02(a), and shall include full compensation for the handling costs of the Contractor and the profit in connection with the construction Works carried out by the Targeted Enterprise subcontractors.

The provisional sum for sub item F10.02(c) is provided to cover the total cost of the materials and small construction equipment supplied by the Contractor to assist the Targeted Enterprise subcontractors based on proof of payment made by the Contractor, as certified by the Employer's Agent, in separate payments for each Targeted Enterprise subcontractor in accordance with Part G of the Particular Specifications.

The tendered percentage for sub item F10.02(e)(i) shall be the Number of Needs analysis and enterprise development plan per Targeted Enterprise. Only one (1) plan will be developed per Targeted Enterprise. The rate shall include full compensation for the development of the Needs Analysis Plan to the satisfaction of the Employer, meeting all the CIDB requirements and shall including any consultations undertaken by the contractor in the development of the plans.

The unit of measure for subitem F10.02(e)(ii) shall be Per Quarter of Monitoring and Interim Reporting per Targeted Enterprise. Payment shall only be made for the period the appointed Targeted Enterprise subcontractors are on site in the execution of the works. The tendered rate shall include full compensation for the conclusion of all the subcontract agreements and the management of all Targeted Enterprise subcontractors, including for the provision of the necessary management support, coaching, guidance and mentoring to the Targeted Enterprise subcontractors.

The unit of measure for subitem F10.02(e)(iii) shall be the Number of Project Completion Reports Completed per Targeted Enterprise. Only one (1) report will be developed per Targeted Enterprise. The rate shall include full compensation for the development of the Completion Report to the satisfaction of the Employer, meeting all the CIDB requirements and shall including any consultations undertaken by the contractor in the development of the report.

The Skills Development Co-Ordinator under subitem F10.02(e)(iv) shall be compensated as per the Number (No) of Targeted Sub Contractors currently employed and actively working on site only for the month. The rate shall include full compensation for all costs associated with developing a project specific Enterprise Development plan and submitting to the employer's representative a monthly enterprise development report (Performa – ED105P) all as per the provisions of F9.13. This rate shall also include any travelling, incidentals, communication costs and any other costs deemed as a requirement for the Skills Development Co-Ordinator to execute their duties. No other claims may be made anywhere else which shall be associated with the Skills Development Co-Ordinator.

Item	Unit
F10.03 Training of Targeted Enterprise subcontractors:	
(a) Generic skills:	
(i) Training costs.....	provisional sum (Prov sum)
(ii) Handling costs and profit in respect of sub item F10.03(a)(i)	percentage (%)
(b) Entrepreneurial skills:	
(i) Training costs.....	provisional sum (Prov sum)
(ii) Handling costs and profit in respect of sub item F10.03(b)(i)	percentage (%)
(c) Construction skills:	
(i) Training costs.....	provisional sum (Prov sum)
(ii) Handling costs and profit in respect of sub item F10.03(c)(i)	percentage (%)
(d) Transportation and accommodation costs of selected learners only, while receiving off-site training:	
(i) Transportation and accommodation costs	provisional sum (Prov sum)

(ii) Handling costs and profit in respect of sub item F10.03(d)(i) percentage (%)

Expenditure under sub items F10.03(a)(i), (b)(i), (c)(i) and (d)(i) shall be in accordance with clause 6.6 of the General Conditions of Contract 2015.

The provisional sum for each of sub items F10.03(a)(i), (b)(i) and (c)(i) is provided to cover the total costs of the required training in generic skills, entrepreneurial skills and construction skills respectively, including for the procurement of the services of the accredited trainers and their delivery of the training courses to the learners employed by Targeted Enterprise subcontractors, the provision of all training materials including all stationery and study materials, and the wages of the learners for the duration of the courses. The payment of wages to learners in terms of sub items F10.03(a)(i), (b)(i) and (c)(i) will only be made to those learners who attend and successfully complete each course of the approved training programme. Payment shall not be made to learners who, once selected, do not attend or only partially complete structured training courses.

The Contractor's own personnel shall be permitted to attend the training courses provided for the learners employed by the Targeted Enterprise subcontractors only to the extent that the venue and its facilities can efficiently and comfortably accommodate the additional number of learners. All additional costs relating to such attendance by the Contractor's own personnel shall be carried by the Contractor and shall not be considered for payment in terms of item F10.03, including for any additional costs related to the accredited trainers and their delivery of the training courses, the provision of additional training materials, and the wages of the learners from the Contractor's own personnel for the duration of the courses.

The tendered percentage for each of sub items F10.03(a)(ii), (b)(ii) and (c)(ii) is the percentage of the amount actually spent under each of sub items F10.03(a)(i), (b)(i) and (c)(i) respectively, and shall include full compensation for the handling costs of the Contractor, and the profit in connection with the provision of the training in generic skills, entrepreneurial skills and construction skills respectively, including for the costs of record keeping and reporting with respect to the training received by each learner, and the costs of the compilation of the portfolio of evidence with respect to each Targeted Enterprise subcontractor.

The provisional sum for sub item F10.03(d)(i) is provided to cover all costs related to the transportation and accommodation costs of selected learners only, while receiving off-site training, where such learners have been specifically selected in conjunction with the Employer's Agent to receive such off-site training and where such training cannot be delivered using the training venue facility provided by the Contractor.

The tendered percentage for sub item F10.03(d)(ii) is the percentage of the amount actually spent under sub item F10.03(d)(i), and shall include full compensation for the handling costs of the Contractor, and the profit in connection with the transportation and accommodation costs of selected learners only, while receiving off-site training.

BILL OF QUANTITIES
PART G: SMALL CONTRACTOR DEVELOPMENT

CONTRACT NO. ZNB01307/00000/00/POR/INF/22/T: PROVISION OF MAINTENANCE ON VARIOUS PROVINCIAL ROADS OVER A PERIOD OF 36 MONTHS WITHIN UMZUMBE SOUTHERN ZONE 1 UNDER COST CENTRE PORT SHEPSTONE IN THE DURBAN REGION

C1.3		CONTRACTOR'S ESTABLISHMENT ON SITE AND GENERAL ON SITE AND GENERAL OBLIGATIONS		
ITEM	DESCRIPTION	UNIT	QTY	
C1.3.1	The Contractor's general obligations			
C1.3.1.1	Fixed obligations	lump sum	1	
C1.3.1.2	Value-related obligations	lump sum	1	
C1.3.1.3	Time-related obligations	month	36	

C1.5	ACCOMMODATION OF TRAFFIC			
ITEM	DESCRIPTION	UNIT	QTY	
C1.5.7	Temporary traffic control facilities			
C1.5.7.1	Delineators including mounting bases and ballast:			
	(a)Single sided, reversible left or right (1000mm x 250mm)		1 261	
	(b)Double sided, reversible left or right (1000mm x 250mm)	No	260	
	(c)Double sided, reversible left or right (1000mm x 300mm)	No	27	
C1.5.7.2	Traffic cones, minimum height 750mm	No	560	
PSC1.5.7.3	Flagmen, including portable Stop-Go signage, red warning flag or an amber LED strobe wand, etc	man-days	3 000	
C1.5.7.4	Traffic controllers	man-shift	1 200	
C1.5.12.1	Provision of additional traffic accommodation facilities	provisional sum	1	

C1.5		ACCOMMODATION OF TRAFFIC		
ITEM	DESCRIPTION	UNIT	QTY	
C1.5.12.2	Handling cost, profit and all other charges in respect of item C1.5.12.1	%		
PSC1.5.13.1	Blading by Road Grader of < 6m			
	(a) Machine Trimming: Normal Blading to L-Type Roads – Without Watercart to Grade 3% Camber, but including Grader Assistant, etc	km	77	
	(b) Machine Trimming: Dry Road Blading L-Type Roads using Watercart – 3% camber, but including Grader Assistant, etc	km	77	
PSC1.5.13.2	Blading by Road Grader of > 6m			
	(a) Machine Trimming: Normal Blading to D & P-Type Roads– Without Watercart to Grade 3% Camber, but including Grader Assistant, etc	km	171	
	(b) Machine Trimming: Dry Road Blading D & P-Type Roads using Watercart – 3% camber, but including Grader Assistant, etc	km	171	

C1.6	CLEARING AND GRUBBING			
ITEM	DESCRIPTION	UNIT	QTY	
C1.6.3	Removal and grubbing of large trees and tree stumps:			
C1.6.1.1	Clearing with machines and some hand labour where necessary	ha	3	
C1.6.3.1	Girth equal to or exceeding 1,0m up to and including 2,0m	No	81	

C3.1		DRAINS		
ITEM	DESCRIPTION	UNIT	QTY	
C3.1.1	Excavation for open drains:			
C3.1.1.1	Excavating all material situated within the following depth ranges below the surface level using conventional methods:			
	(a) 0m to 1.5m (V-drain, Mitre drains and Meadow drains)	m ³	5	
C3.1.1.2	Extra over sub-item C3.1.1.1 for excavation in hard and boulder material, irrespective of depth	m ³	0.3	
C3.1.2	Clearing, shaping and disposal of accumulated sediment in existing unlined open drains			
C3.1.2.1	Using conventional methods (v-drains, mitre drain)	m ³	3 000	
C3.1.3	Excavation, clearing and disposal of accumulated sediment in existing lined drains and drainage systems			
C3.1.3.1	Using conventional methods (up to 1,5m):			
	(a) Manholes and inlet and outlet structures	m ³	2	
	(b) Culvert barrels	m ³	1	
	(c) Concrete or other lined side drains	m ³	120	
C3.1.3.3	Using labour enhanced construction methods:			
	(a) Manholes and inlet and outlet structures	m ³	2	

C3.1	DRAINS			
ITEM	DESCRIPTION	UNIT	QTY	
C3.1.15	(b)Culvert barrels	m ³	3	
	(c)Concrete or other lined side drains	m ³	116	
	Repairing or replacing existing drainage systems	provisional sum	1	
	Handling cost, profit and all other charges in respect of item C3.1.15	%		

C3.2		CULVERTS		
ITEM	DESCRIPTION	UNIT	QTY	
C3.2.1	Excavation for culvert structures			
C3.2.1.1	Excavating in all material situated within the following depth ranges below the surface level			
	(a) 0m up to 1,5m.	m ³	650	
	(b) Exceeding 1,5m up to 3,0m.	m ³	40	
C3.2.1.4	Extra over sub-item C3.2.1.1 for excavation in hard or boulder material, irrespective of depth	m ³	43	
C3.2.2	Backfilling:			
C3.2.2.1	Using the excavated material	m ³	500	
C3.2.2.2	Using imported selected material			
	(a) From commercial sources (Type G5B Material)	m ³	100	
C3.2.3	Concrete pipe culverts with Spigot and Socket joint ends:			
C3.2.3.3	On Class C bedding			
	(a) 450mm dia. Type 100D	m	42	
	(b) 600mm dia. Type 100D	m	180	

ITEM	DESCRIPTION	UNIT	QTY	
C3.2.7	Cast in situ concrete and formwork:			
C3.2.7.2	In complete in situ floor slabs for rectangular culverts, manholes and catchpits including formwork, joints and Class U2 surface finish (installed at a standard depth of 1,0m)			
	(a) Class 30/20 concrete	m ³	38	
C3.2.10.3	Welded steel fabric (Ref 193)	kg	380	
C3.2.10.4	Other material (Brickforce BF150-28)	kg	50	
C3.2.16.2	230mm thick	m ²	200	
C3.2.17	Plaster	m ²	60	
C3.2.18	Benching (class C20/25-14 concrete)	m ³	4	

C3.3		CONCRETE KERBING AND CHANNELING, ASPHALT BERMS, CHUTES, DOWNPIPES, AS WELL AS CONCRETE, STONE PITCHED AND GABION LININGS FOR OPEN DRAINS		
ITEM	DESCRIPTION	UNIT	QTY	
C3.3.1	Concrete kerbing:			
C3.3.1.1	Prefabricated kerbing			
	(a) Precast kerb FIG 3 (to SABS 927 - refer Concrete Pavement Detail)	m	36	
C3.3.1.2	Cast in situ kerbing			
	State type of kerb, class of concrete with reference to drawing	m	0.2	
C3.3.3	Extra over items C3.3.1 and C3.3.2 for concrete kerbing or concrete kerbing and channeling on curves			
C3.3.3.1	On curves of radii more than or equal to 5,0m but less than 20m	m	4	
C3.3.6	Concrete chutes (SD0603/A):			
C3.3.6.2	(a) Chute including 5m transition, 2m straight channel and stone pitching erosion protection (As shown on Drawing SD 0603/A and SD 0603/2)	m	0.1	

C8.1	PRIME COAT			
ITEM	DESCRIPTION	UNIT	QTY	
C8.1.3	Extra over item C8.1.1 for applying the prime coat accessible only to hand-held or light equipment			
C8.6.7.1	Tack Coat	ℓ	3 000	

C8.4	RUT AND/OR DEPRESSION CORRECTION			
ITEM	DESCRIPTION	UNIT	QTY	
C8.4.1	Rut and/or Depression correction (screeding)			
C8.4.1.1	Bond coat using 50% diluted stable grade bitumen emulsion	ℓ	21	
PSC8.4.1.2	Correction material, including Saw Cutting and forming 2 No of 50 x 40mm keys both sides of the rut			
	(a) Continuously-graded asphalt (14mm NMPS, A-E2 modified binder)	t	1	

C8.5	STANDARD CRACK SEALING			
ITEM	DESCRIPTION	UNIT	QTY	
C8.5.1	Standard crack sealing			
C8.5.1.1	Cleaning cracks			
	(a) Cleaning crack with cold compressed air	m	90	
C8.5.1.2	Applying herbicides for sealing cracks	ℓ	13	
C8.5.1.3	Primer (invert bitumen emulsion complying with SANS 4001 – BT5)	ℓ	10	
C8.5.1.4	Sealing the cracks			
	(a) Sealing using (C-E1 modified binder crack sealant)	ℓ	25	
C8.5.1.5	Heating of surface before rolling	m	90	
C8.5.1.6	Rolling the cracks	m	90	

C8.8		PATCHING AND EDGE BREAK REPAIR		
ITEM	DESCRIPTION	UNIT	QTY	
C8.8.1	Saw cutting pavement layers for patching			
C8.8.1.1	Asphalt or bituminous surfacing to an average depth			
	(a) Not exceeding 50 mm	m	500	
	(b) Exceeding 50 mm but not exceeding 100 mm	m	100	
	(c) Exceeding 100 mm	m	500	
C8.8.2	Excavation in existing pavements for patching (non-milling)			
C8.8.2.1	Asphalt layers			
	(a) Not exceeding 10 m ² including for edge repairs wider than 250mm	m ³	2	
	(b) Exceeding 10 m ² but not exceeding 50 m ² including for edge repairs wider than 250mm	m ³	5	
	(c) Exceeding 50 m ² up to 100 m ² including for edge repairs wider than 250mm	m ³	7	
	(d) Exceeding 100 m ²	m ³	100	
C8.8.2.2	Cemented layers			
	(a) Not exceeding 10 m ² , including for edge repairs wider than 250 mm	m ³	1	
	(b) Exceeding 10 m ² but not exceeding 50 m ² , including for edge repairs wider than 250 mm	m ³	2	
	(c) Exceeding 50 m ² up to 100 m ² , including for edge repairs wider than 250 mm	m ³	6	
	(d) Exceeding 100 m ²	m ³	70	
C8.8.2.3	Other layers (Granular layers)			
	(b) Exceeding 10 m ² but not exceeding 50 m ² , including for edge repairs wider than 250 mm	m ³	2	
	(d) Exceeding 100 m ²	m ³	80	

C8.8		PATCHING AND EDGE BREAK REPAIR		
ITEM	DESCRIPTION	UNIT	QTY	
C8.8.3	Compacting the floor of excavations for patching (97% MOD)	m ²	3 000	
C8.8.4	Backfilling of excavations for patching with:			
C8.8.4.1	Chemically stabilized pavement material (G2 material using 3% cem III 32,5 N cement) for a patch with a surface area:			
	(a) Not exceeding 10 m ² , including for edge repairs wider than 250 mm	m ³	3	
	(b) Exceeding 10 m ² but not exceeding 50 m ² , including for edge repairs wider than 250 mm	m ³	7	
	(c) Exceeding 50 m ² up to 100 m ² , including for edge repairs wider than 250 mm	m ³	6	
	(d) Exceeding 100 m ²	m ³	50	
C8.8.4.3	Asphalt for a patch with a surface area(Sand skeletal mix – continuously graded)			
	(a) Not exceeding 10 m ² , including for edge repairs wider than 250 mm	t	5	
	(b) Exceeding 10 m ² but not exceeding 50 m ² , including for edge repairs wider than 250 mm	t	8	
	(c) Exceeding 50 m ² up to 100 m ² , including for edge repairs wider than 250 mm	t	10	
	(d) Exceeding 100 m ²	t	12	
C8.8/ PSC1.5.7.7	Traffic calming devices			
	(a) Installation of rumble strips (Refer to Standard Detail 0307/A) (See C11.6 for signage)	m	23	
	(b) Installation of speed hump (Refer to Standard Detail 0314) (See C11.6 for signage)	m	60	

C9.1	ASPHALT LAYERS			
ITEM	DESCRIPTION	UNIT	QTY	
C9.1.13	Coring of asphalt layers			
C9.1.13.1	100mm diameter	No	10	

C11.1	PITCHING, STONEMWORK, CAST IN SITU CONCRETE FOR PROTECTION AGAINST EROSION			
ITEM	DESCRIPTION	UNIT	QTY	
C11.1.2	Stone pitching			
C11.1.2.2	Grouted stone pitching with mortar	m ²	80	

C11.3	GUIDE BLOCKS AND KILOMETRE MARKERS			
ITEM	DESCRIPTION	UNIT	QTY	
C11.3.2	Kilometre markers	No.	10	

C11.4		ROAD RESTRAINT SYSTEMS		
ITEM	DESCRIPTION	UNIT	QTY	
C11.4.1	Erecting of guardrails at 3,81 m spacing			
C11.4.1.1	Complete galvanized system compliant to SANS 1350:			
	(a) On timber posts (SD1101/B)	m	120	
C11.4.1.2	Terminal sections for 3,81 guardrails comprising of:			
	(a) End wings to SANS 1350	No	20	
C11.4.7	Removing existing guardrails:	m	1 500	
C11.4.9.1	Single guardrail	m	1 000	

C11.6		ROAD SIGNS		
ITEM	DESCRIPTION	UNIT	QTY	
C11.6.1	<p>Road signboards with painted or coloured semi-matt background. Symbols, lettering and borders in semi- matt black or in Class I retro-reflective material, where the sign board is constructed from:</p> <p>Chromadek, steel plated Regulatory, Warning and information signs:</p> <p>(i) Area not exceeding 2m²</p>	m ²	1	
C11.6.1.7	<p>Regulatory signs, permanent</p> <p>(a) 600 mm diameter (pre-painted galvanized steel plate, background class 1, symbol class 1)</p> <p>(b) 900 mm diameter (pre-painted galvanized steel plate, background class 1, symbol class 1)</p> <p>(c) 1200 mm diameter (pre-painted galvanized steel plate, background class 1, symbol class 1)</p>	No	6	
		No	5	
		No	1	

C11.7		ROAD MARKINGS AND ROAD STUDS		
ITEM	DESCRIPTION	UNIT	QTY	
C11.7.2	Retro-reflective road marking:			
C11.7.2.1	White lines broken or unbroken Type 1 paint, to widths:			
	(a) 100mm	km	7	
C11.7.2.2	Yellow lines broken or unbroken 150mm wide (Type 1 paint)	km	12	
C11.7.2.4	White lettering and symbols Type 1 paint	m ²	150	
C11.7.2.7	Transverse lines, painted island and arrestor bed markings (any colour) (Type 1 paint)	m ²	64	
C11.7.2.8	Hand painted white lines broken or unbroken (Type 1 Paint)			
	(a) 200mm	m ²	18	
	(b) 300 mm	m ²	27	
C11.7.7	Road studs			
C11.7.7.1	Permanent road studs compliant to SANS 1442 (Bi-directional, Stimsonite or similar)			
	(i) White	No.	250	
	(ii) Yellow	No.	600	
C11.7.8	Setting out and premarking the lines (excluding traffic island markings, lettering and symbols)	km	8	

C11.8	LANDSCAPING AND PLANTING PLANTS			
ITEM	DESCRIPTION	UNIT	QTY	
PSC11.8.7	<p>Mowing the grass</p> <p>(a) Mowing/cutting the grass, shrubs, reeds, etc, to a height of 50mm above ground level, 3.0m from the edges of the road and to the medians where applicable, including carting off Site to an approved Dump Site. (Note: ha=10 000 m2)</p> <p>(i) Cutting of Grass and Shrubs (3m wide on either side)</p>	ha	132	
C11.8.12	<p>Removal of undesirable vegetation</p>	m ²	79 434	

C12.6	MECHANICALLY STABILISED EARTH AND GABIONS			
ITEM	DESCRIPTION	UNIT	QTY	
C12.6.1	Establishment on site for MSE			
C12.6.14	Foundation trench excavation			
C12.6.14.1	Excavating all material situated within the following depth ranges below the surface level			
	a) 0 m to 1.5m	m ³	260	
C12.6.14.2	Extra over sub-item C11.2.1.1 for excavation in hard material, irrespective of depth	m ³	27	
C12.6.15	Surface preparation for bedding the gabion boxes & mattresses	m ²	92	
C12.6.16	Gabion Boxes and Mattresses:			
	Galvanised Gabion Boxes & Mattresses			
C12.6.16.1	2m x 1m gabion baskets	m ³	17	
	1,5m x 1m x 1m x 2 layers (Total 2m high) gabion baskets	m ³	240	
	1m x 1m x 1m layer gabion baskets	m ³	60	
C12.6.17	Geotextile Filter fabric (200g/m ² - Grade C Light Separation)	m ²	350	

C14.9	REPAIR AND REPLACEMENT OF ANCILLARY STRUCTURAL ELEMENTS			
ITEM	DESCRIPTION	UNIT	QTY	
C14.9.6	Repair of handrails (description of work)	m	2	
C14.9.15.1	Cleaning of Scuppers on bridge	m	5	

C3.3 PARTICULAR SPECIFICATIONS

PART G: CIDB CONTRACT SKILLS DEVELOPMENT GOAL (CSDG)

PART G: CIDB CONTRACT SKILLS DEVELOPMENT GOAL (CSDG)

G1. SCOPE

This part provides the specifications with regard to the following:

- (a) The Contract Skills Development Goals as per the Standard for developing skills through infrastructure contracts, 2020 as gazetted in the Government Gazette No. 43495, 3 July 2020.

The below specifications are intended as a guide and are to be read in conjunction with the above-mentioned standards for the implementation of the programme.

G2. STANDARD FOR DEVELOPING SKILLS THROUGH INFRASTRUCTURE CONTRACTS

The South African government requires that its considerable expenditure on the delivery, maintenance and operation of infrastructure (fixed assets that are constructed or result from construction operations) contribute to an increase in the number of people who have part or full occupational qualifications registered on the NQF or professional designations awarded by professional bodies or statutory councils.

The CIDB B.U.I.L.D Standard for developing skills through infrastructure contracts has been prepared to leverage contributions towards the increase of the pool of qualified skilled people, and where required professionally registered, through training on professional services, services, design and build or engineering and construction works contracts associated with such expenditure. This standard establishes a minimum contract skills development goal which is to be achieved in the performance of a contract in relation to the provision of different types of workplace opportunities linked to work associated with a contract which culminate in or lead to:

- a) a part or full occupational qualification registered on the National Qualification Framework;
- b) a trade qualification leading to a listed trade (GG No. 35625, 31 August 2012);
- c) a national diploma registered on the National Qualification Framework; and
- d) registration in a professional category by one of the professional bodies listed in Table 1 below.

Table 1: Categories of registration

PROFESSION	CATEGORY OF REGISTRATION	ACT
Construction project management	Construction Project Manager	Project and Construction Management Professions Act of 2000 (Act No. 48 of 2000)
Engineering	Engineer, Engineering Technologist, Engineering Technician or Certificated Engineer	Engineering Profession Act of 2000 (Act No. 46 of 2000)

The Contractor shall be responsible for achieving the contract skills development goal and are provided with a number of methods for measuring their achievements. They may, if need be, devolve their obligations onto subcontractors.

G3. REQUIREMENTS

G3.1 CONTRACT SKILLS DEVELOPMENT GOAL (CSDG)

G3.1.1 The contractor shall attain or exceed the contract skills development goal OF 0.25% in the performance of the contract or the execution of an order.

G3.1.2 Where required in terms of the contract, a specified proportion of the learners and candidates shall be selected from persons in the employ of the state who meet the relevant eligibility

criteria for the relevant programme.

G3.1.3 Where required in terms of the contract or order, the employer shall advise the contractor of the types of training to be undertaken by the learners and candidates based on the needs and requirements of the candidate's qualifications.

G3.2 ACHIEVING THE CONTRACT SKILLS DEVELOPMENT GOAL (CSDG)

G3.2.1 The contractor shall achieve the measurable contract skills development goal by providing opportunities to learners requiring structured workplace learning using one or a combination of any of the following in relation to work directly related to the contract

Method 1: structured workplace learning opportunities for learners towards the attainment of a part or a full occupational qualification;

Method 2: structured workplace learning opportunities for apprentices or other artisan learners towards the attainment of a trade qualification leading to a listed trade (GG No. 35625, 31 August 2012) subject to at least 60% of the artisan learners being holders of public TVET college qualifications;

Method 3: work integrated learning opportunities for University of Technology or Comprehensive University students completing their national diplomas;

Method 4: structured workplace learning opportunities for candidates towards registration in a professional category by a statutory council listed in Table 1 above.

G3.2.2 Employed learners may not account for more than 33 percent of the contract skills development goal.

G3.2.3 Not more than one method may be applied to any individual concurrently in the calculation of the contract skills development goal.

G3.3 CONTRACT SKILLS DEVELOPMENT GOAL CREDITS

G3.3.1 Contract skills development credits will not be awarded for learners enrolled as beneficiaries of other funded or subsidised programmes.

G3.3.2 In the case of engineering and construction works, design and build and services contracts:

- a) The contract skills development goals shall be granted by multiplying the number of people employed by the contractors and placed for continuous training opportunities in a three-month period by the notional values contained in Table 3 as published in the Standard for developing skills through infrastructure contracts, 2020 as gazetted in the Government Gazette No. 43495, 3 July 2020, or as revised in a Gazette notice.
- b) The contractor may source beneficiaries of the contract skills development goal from the cidb Skills Development Agency (SDA).
- c) All beneficiaries of the Standard must be registered with the cidb SDA.

G3.4 DENIAL OF CREDITS

Credits towards the contract skills development goal shall be denied should:

- a) the opportunities not be provided on site or the opportunities cannot be directly linked to the contract;
- b) Failure to register all beneficiaries of the Standard be with the cidb SDA;
- c) Failure to submit a copy of the final contract compliance training report within 15 days of practical completion;

- d) the following not be provided:
 - 1) the required contract compliance baseline plan, an interim contract compliance report or a final contract compliance report;
 - 2) the required mentorship plan for a candidate not be provided;
 - 3) the required training plan for learners not be provided;
 - 4) the training reports covering a period not be provided;
 - 5) the required records, specified documents and signatures not be provided;
 - 6) the structured mentorship is found not to be in accordance with the requirements of the applicable professional body, statutory council or qualifying authority;
 - 7) the structured workplace learning is found not to be in accordance with the curriculum requirements of the part qualification or occupational qualification or prescription for professional registration for which the learner is registered;
- e) conditions of employment and rates of allowances for learners not be in accordance with legislative provisions; and
- f) the contractor does not maintain the required training records, or an audit reveals that there is insufficient information to substantiate claims for credits.
- g) the contractor claims credits for learners enrolled as beneficiaries on programmes that are funded or subsidised from another source.
- h) the contractor fails to provide sufficient evidence of disciplinary actions taken against a learner who fails to present their interim reports or credentials for assessment when they have had sufficient structured work experience or structured mentorship to do so.

G4 COMPLIANCE WITH REQUIREMENTS

G 4.1 GENERAL

G 4.1.1 The contractor shall submit to the employer's representative:

- a) within 30 days of the contract coming into effect or the issuing of an order, a contract compliance baseline training plan taking into account the skills mix and type of workers that are to be engaged;
- b) interim contract compliance training reports at intervals which do not exceed 3 months; and
- c) a final contract compliance training report within 15 days of reaching practical completion of the construction works.

G4.1.2 The information contained in the final contract compliance training report shall include the contract skills development goal achieved (in Rands or in hours) in the performance of the contract and a breakdown of the goal achieved in respect of the following:

- a) the name and contact details of the SDA,
- b) the skills mix and skills types achieved on the contract; and
- c) the names, ID numbers and period of employment of each learner and
- d) candidate.

G4.1.3 The contractor shall keep records of the hours worked and registration particulars towards compliance with this standard. The contractor shall allow the employer's representative to inspect or audit such training records at any time.

G4.1.4 The employer's representative shall undertake suitable random audits on records to confirm compliance with requirements.

G4.1.5 The learners shall be directly employed by the contractor or SDA. The contractor shall enter into a contract agreement with the cidb SDAs, training provider or skills development facilitator of their choice participating in the implementation of this standard to:

- a) prepare training plans for registered learners, including details of the scope of experiential work to be covered and expected outcomes;

- b) register learners with the appropriate Sector Education and Training Authority established in terms of the Skills Development Act of 2008 (Act 37 of 2008);
- c) manage learner registration with appropriate trade testing authorities as well as preparation for the trade test;
- d) liaise with the supervisor to monitor onsite training progress of learners;
- e) liaise with the supervisor to arrange for summative assessments at appropriate stages of the training; and
- f) liaise with the supervisor to prepare reports for the employer or employer's representative.

G4.2 STRUCTURED WORKPLACE LEARNING OPPORTUNITIES FOR LEARNERS

G4.2.1 Structured workplace learning opportunities shall be aligned to the curriculum requirements set for the particular part or full occupational qualification or professional designation for which the learner is registered.

G4.2.2 A responsible supervisor will be appointed to allocate learning tasks, under the guidance of a competent person, to learners in line with their training plans.

G4.2.3 Mentoring associated with structured workplace learning for artisan learners shall be undertaken by an artisan in the applicable trade with a minimum of 3 years of trade specific experience. The number of artisan learners mentored by a single mentor shall, unless otherwise permitted by the National Artisan Moderation Body, not exceed 4 at any one time.

G4.2.4 Supervision associated with structured workplace learning for learners leading to a part or full occupational qualification other than artisan learners shall be undertaken by a person qualified in the applicable discipline with a minimum of 3 years of post qualification experience.

G4.2.5 The contractor shall submit to the employer's representative, in respect of each learner:
a) within one month of commencing work directly related to the contract or order, a workplace training plan together with name of the learner's mentor and supervisor;

- b) within one month of commencing work directly related to the contract or order:
 - 1) proof of registration as a learner with the relevant SETA where applicable; and
 - 2) a copy of the mentorship agreement entered into with the learner or the company mentorship agreement entered into with the relevant qualified agency;

- c) within two weeks of updating a workplace training plan, the revised workplace training plan;
- d) a quarterly progress report and a final report at the end of the structured mentorship period including a log of exposure and interactions with the mentor in sufficient detail to demonstrate compliance with requirements, signed off by the mentor, the supervisor and the learner.

G4.2.6 Learners shall be required by the mentor to complete training reports required by the relevant qualifying authority whenever a substantial activity or training period has been completed.

G4.2.7 The mentor and supervisor shall sign off all reports and logbooks to allow the learner to move to other projects or employment and continue the path towards a qualification.

G4.3 STRUCTURED WORKPLACE LEARNING FOR CANDIDATES

G4.3.1 Mentoring associated with structured workplace learning for candidates shall be in accordance with the prescripts of the relevant professional body or statutory council.

G4.3.2 The contractor shall:

- a) appoint a supervisor who is actively engaged in work directly associated with the contract to issue tasks, oversee their implementation and provide input to the candidate on an on-going basis;
- b) identify a suitable mentor for the candidate. If the contractor does not have an inhouse

mentor, the contractor shall enter into a mentoring agreement with the candidate and an external company as required by the professional body or statutory council; and

- c) issue each candidate with a portfolio of evidence file which is to be kept up to date with all the documentation issued or prepared including the workplace training plan and all revisions thereof as well as copies of the logbook entries and training experience reports.

G4.3.3 The mentor shall from time to time provide an updated workplace training plan for a candidate outlining the activities in which the candidate will be involved, including activities required by the relevant professional body or statutory council. The mentor shall require candidates to maintain a logbook issued by the relevant professional body or statutory council. The mentor shall sign off such logbook at quarterly presentations and progress review meetings.

NOTE: The mentor should ensure where the duration of the contract or order exceeds the minimum time to register in a professional category of registration that candidates are exposed to the full range of activities and work towards assuming the full level of responsibility recommended by the relevant professional body or statutory council. This may require rotations and secondments.

G4.3.4 The contractor shall submit to the employer's representative, in respect of each candidate:

- a) within one month of commencing work directly related to the contract or order:
- 1) a workplace training plan together with name of the candidates' mentor and supervisor;
 - 2) proof of registration as a candidate with the relevant professional body or statutory council; and
 - 3) register all beneficiaries of the Standard with the cidb SDA

b) within one month of commencing work directly related to the contract or order a copy of the mentorship agreement entered into with the candidate or the company mentorship agreement entered into with a professional body or statutory council;

- c) within two weeks of updating a workplace training plan, the revised workplace training plan;
- d) quarterly progress reports and a final report at the end of the structured mentorship period including a log of exposure and interactions with the mentor in sufficient detail to demonstrate compliance with requirements, signed off by the mentor, the supervisor and the candidate.

G4.3.5 Candidates shall be required by the mentor to complete training reports required by the relevant professional body or statutory council whenever a substantial activity or training period has been completed.

G4.3.6 The mentor and supervisor shall sign off all reports and logbooks to allow the candidate to move to other projects or employment and continue on the path towards registration where the work related to the contract ends for whatever reason prior to the candidate gaining sufficient experience for registration.

G5 RECORDS

G5.1 The contractor shall submit all the documentation required in terms of clause 4 in a timely manner and according to a prescribed format where applicable. The contractor shall submit to the Employer's Representative the following proformas:

- Form A2 Baseline Training Plan
- Form A3 Project Interim Report
- Form A5 Project Completion Report

G5.2 The employer's representative shall certify the value of the credits counted towards the contract skills development goal, if any, whenever a claim for payment is issued to the employer and shall notify the contractor of this amount.

G5.3 The contractor shall, upon termination of the opportunities provided in order to satisfy the contract skills development goal, certify the quantum and nature of the opportunity and submit the certificate, counter-certified by the relevant individual, to the employer's

representative for record-keeping purposes.

G5.4 PRO-FORMA DOCUMENTS

The following Annexures are contained at the end of Part G Specifications and shall be used by the contractor in relation to all the reporting requirements.

- Annexure 1 - Form A1 List of Recognised Skills Development Agencies
- Annexure 2 - Form A2 Baseline Training Plan
- Annexure 3 - Form A3 Project Interim Report
- Annexure 4 - Form A4 Supervisor Agreement
- Annexure 5 - Form A5 Project Completion Report

G6 SANCTIONS

G6.1 In the event that the contractor fails to substantiate that any failure to achieve the contract skills development goal was due to reasons beyond the contractor's control which may be acceptable to the employer, the sanctions provided for in the contract shall apply.

G7 MEASUREMENT AND PAYMENT

Item	Unit
G7.01	Payments associated with the Contract Skills Development Goals:
(a)	Employment of Learners employed under Method 1
	(i) Provision for stipends..... Number (No.)
	(ii) Provision for additional Costs..... Number (No.)
(b)	Employment of Learners employed under Method 2
	(i) Provision for stipends..... Number (No.)
	(ii) Provision for additional Costs..... Number (No.)
(c)	Employment of Learners employed under Method 3
	(i) Provision for stipends..... Number (No.)
	(ii) Provisions for mentorship..... Number (No.)
	(iii) Provision for additional Costs..... Number (No.)
(d)	Employment of Candidates employed under Method 4
	(i) Provision for stipends..... Number (No.)s
	(ii) Provisions for mentorship..... Number (No.)
	(iii) Provision for additional Costs..... Number (No.)

(e) Liaison with the Employer's project manager and the training service provider:

(i) Liaison conducted by the Construction Manager..... hour (h)

The payment items under subitem G7.01(a)(i), (b)(i), (c)(i) and (d)(i) shall be the stipends associated with each Number of Students/Learners/Candidates employed under each methods for the duration of the projects and shall be used to cover the cost of stipend payments made by the Contractor to the participants of the Skills Development Programme, including any associated COIDA and UIF payments, all as authorised by the Employer's Agent.

Where an unemployed learner is employed directly by the contractor, the contractor shall pay the stipend directly to the learner.

Where an unemployed learner is sourced through an SDA, training provider or skills development facilitator the contractor must pay the stipend to the SDA, training provider or skills development facilitator who in turn will pay the learner.

The notional cost of providing training opportunities will be increase by CPI on an annual basis. The new, revised costs will be published on the cidb website on the 1st April in each year.

The provisional sum under sub item G7.01(a)(ii), (b)(ii), (c)(iii) and (d)(iii) shall be used to cover all costs associated with the provision personal protective equipment, insurance, medical assessments, course fees and trade tools (where applicable) and storage thereof, assessment, moderation and monitoring of learners., all as authorised by the Employer's Agent.

The unit of measurement for sub items G7.01 (e)(i) and (ii) shall be the hour. The tendered rates shall include full compensation for all costs related to the Construction for time spent at formal liaison meetings authorised and convened by the Employer's Agent for the specific purpose of liaising with the Employer's project manager and / or the training service provider. The payment shall be made only for the time spent in the formal meeting itself. No payment shall be made for time spent during any other on-site liaison, telephonic liaison, e-mail or written correspondence liaison between these parties, or for liaison conducted with the Employer's project manager and / or the training service provider by any other member of the Contractor's site staff or head office personnel, the cost of all of which shall be deemed to be included in the Contractor's time-related obligations under sub item C1.3.1.3

The unit of measure for subitems G7.01 (c)(ii) and (d)(ii) shall be the Number (No) of mentors employed by the contractor to provide any mentorship for students and candidates employed under method 3 and 4, all as authorised by the Employer's Agent, and shall cover all associated costs for mentorship including travelling, preparation of reports, preparation and review of training plans and any other costs associated with the Mentor fulfilling the requirements of Clause G4.3.

Table 3: The notional cost of providing training opportunities per quarter

The costs for providing training opportunities for this contract shall be as detailed in Table 3, and as published by CIDB on the Standards for Skills Development.

Type of Training Opportunity	Provision for stipends (Unemployed learners only)	Provisions for mentorship	Provisions for additional costs*	Total costs	
				Unemployed learners	Employed learners
Method 1					
Occupational qualification	R7 000	R0	R9 000	R16 000	R9 000
Method 2					
TVET College graduates	R14 000	R0	R9 000	R23 000	N/A
Apprenticeship	R14 000	R0	R12 000	R26 000	R12 000
Method 3					
P1 and P2 learners, or a 240 credits qualification	R24 000	R20 000	R4 500	R48 500	N/A
Method 4					
Candidates with a 360 credits qualification	R37 000	R20 000	R4 500	R61 500	R20 000
Candidates with 480 or more credits qualification	R47 000	R20 000	R4 500	R71 500	R20 000

PART G: CIDB CONTRACT SKILLS DEVELOPMENT GOAL (CSDG) ANNEXURES

Annexure 1 Form A1 List of Recognised Skills Development Agencies

CIDB Recognised Skills Development Agencies								
No	Name of SDA	SDA Registration Number	Status	Recognition Date End	Province	Contact Person	Contact Number	Email Address
01	CIDB SDA	SDA/ZA/16/00001	Active	01/04/2025	National	Pranveer Harriparsadh	012 482 7230	pranveerh@cidb.org.za
02						Thabelo Ramaru	012 482 7249	thabelor@cidb.org.za
03								
04								

Annexure 2 - Form A2 Baseline Training Plan

CIDB SKILLS STANDARD BASELINE TRAINING PLAN

Contractor Details						
Contractor Name:						
CRS Number:						
Estimated start date						
Estimated Completion date						
Size of Organisation	Small (1-49 employees)	Medium (50-149 employees)	Large (≥ 150 employees)			

Contractor Contact Details	
Name of Contact Person	
Designation of Contact Person	
Contact Details	Cell Number:
	Landline Number:
	Email address:

Contract Data				
Project Name				
CIDB Contract Number				
Name of Client:				
Project Description				
Final Tender Sum (at tender award)				
Project Location				
Project duration				
Estimated start date				
Estimated Completion date				
Description	Designation	Project Value	CSDG %	Min CSDG Target
Civil Eng.	CE		0.25	
General Building	GB		0.50	
Civil & General Building	CE & GB		0.375	
Electrical Eng.(Building)	EB		0.25	
Electrical Eng.(Infrastructure)	EP		0.25	
Mechanical Eng.	ME		0.25	
Specialist	SW		0.25	
Total				

Construction Skills Development Goal (CSDG) Baseline Training Plan					
Training Method	Number of Employed Learners	Number of Unemployed Learners	Area/s of Specialisation/Trade	Duration of Placement	Total Notional Cost
Method 1: Skills Programme					
Method 2: FET College Graduates/ Apprenticeship					
Method 3: P1 and P2 learners or a 240 credit qualification					
Method 4: Candidacy with 360 credit qualification					
Total					

Note: Refer to Table 3 in the Standard for Developing Skills through Infrastructure Contracts Government Gazette 43495 of 3 July 2020 for the notional costs

Contractor's Representative Name: _____ Designation: _____

Signature: _____ Date: _____

Employer's Representative Name: _____ Designation: _____

Signature: _____ Date: _____

For Office Use for SDA				
Action	Status			
Project verified on CIDB Register of Projects (RoP)	Yes		No	
Training plans developed	Yes		No	
Appropriate learners available	Yes		No	
Target learners sent to contractor	Yes		No	
SDA processes explained to contractor	Yes		No	
Placement plan developed	Yes		No	
Training Method	Percentage (%) contribution to the CSDG			
Method 1				
Method 2				
Method 3				
Method 4				
Total				

CIDB SDA Contact Person: Mr Pranveer Harriparsadh or Thabelo Ramaru
Email address: pranveerh@cidb.org.za or thabelor@cidb.org.za Tel. 012 482 7230/7249

SDA Representative Name: _____ Designation: _____

Signature: _____ Date: _____

Annexure 4 - Form A4 Supervisor Agreement

Memorandum of understanding between Supervisor and Learner

The Contractor is responsible for the effective management of the learning opportunities provided through the cidb *Standard for the Development of Skills through Infrastructure Contracts* (cidb Skills Standard). The attainment of successful learning outcomes and professional development of the learners is largely dependent on the relationship between the assigned Supervisor and the Learner . As a participant in the implementation of the cidb Skills Standard you agree to the Supervisor relationship and commit to endeavour through the challenges of a construction project to give value to the training programme.

The Responsibilities of a Supervisor to the Learner include:

- stimulating a passion for construction
- sharing technical and practical knowledge
- fostering the development of technical and leadership skills
- facilitating networking within the working community
- instilling an expectation of personal growth and learning by the Learner
- developing knowledge and understanding in the areas of health, safety, environment, quality and production
- inculcating professionalism and a desire for continual improvement by the Learner
- creating a nurturing relationship that instils a sense of discipline and professional pride
- giving constructive feedback and
- signing the Learners logbook.

Supervisor's name _____

Signature:

_____ Date: _____

The Responsibilities of a Learner are:

- adhere to the Host Employer's onsite rules and policies
- have an expectation of personal growth and learning
- to be enthusiastic and motivated
- to be open and accept supervision from the Supervisor and other colleagues

- to develop a thorough understanding of health, safety, environment, quality and production
- to have a positive attitude
- to display a strong sense of discipline and to be conscious of time
- to operate within the team
- to take the time to learn and practice new skills
- to make time to fill in your logbook and obtain the Supervisor's signature for completed tasks

Intern's Name: _____ ID No: _____

Signature: _____ Date: _____

PART C4: SITE INFORMATION

PART C4: SITE INFORMATION

<u>TABLE OF CONTENTS</u>	Page
C4.1 LOCALITY PLAN	C204
C4.2 EXAMPLE OF CONTRACT SIGNBOARD DETAILS	C205
C4.3 EXISTING SERVICES REPORT	C207
C4.4 CONDITIONS ON SITE: MATERIALS INFORMATION	C208
C4.5 TRAFFIC INFORMATION	C210
C4.6 STANDARD DETAILS.....	C215
C4.7 ANY OTHER RELEVANT TECHNICAL REPORT	C220

C4.1 LOCALITY PLAN

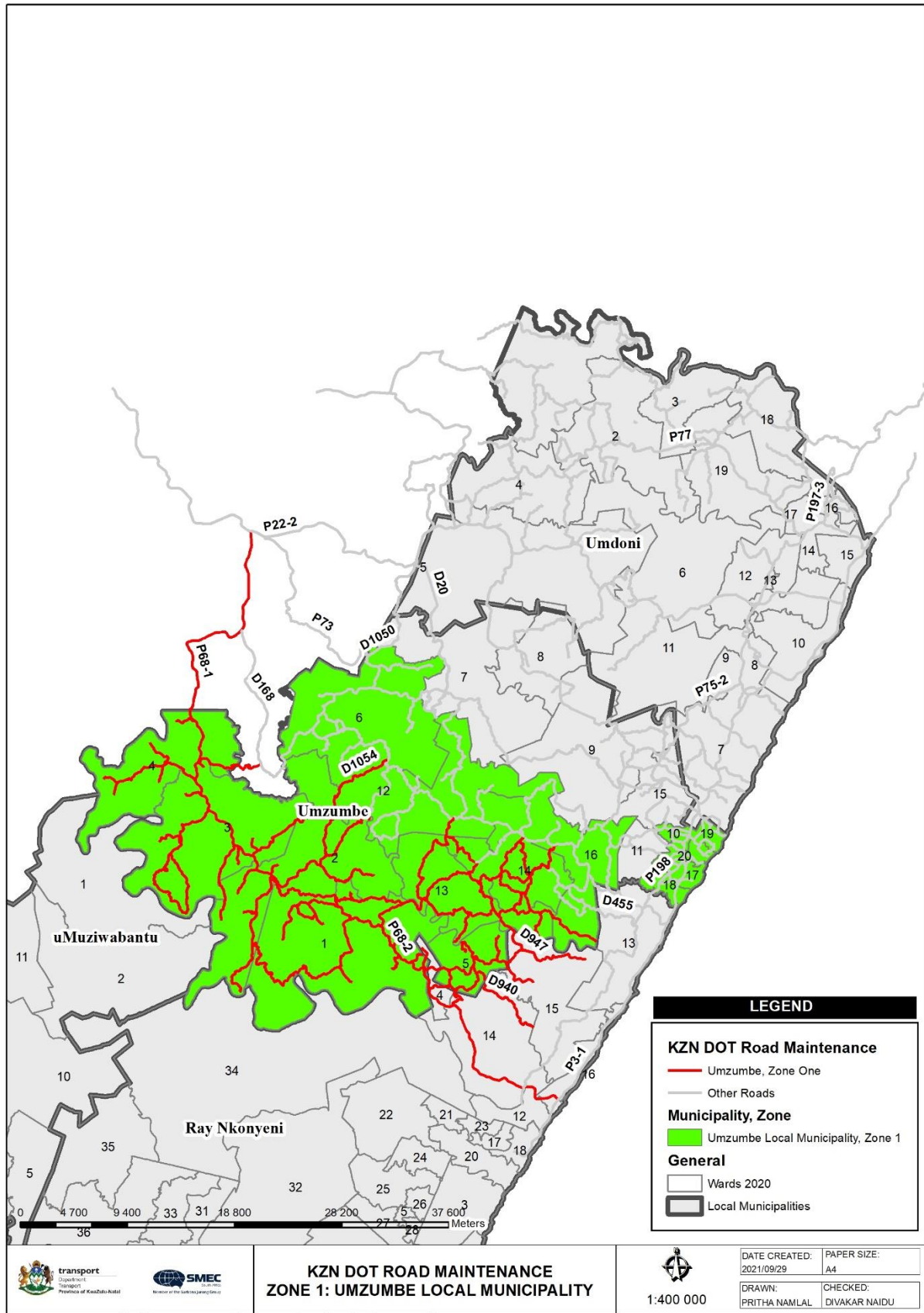

C4.2 EXAMPLE OF CONTRACT SIGNBOARD DETAILS

C4.2.1 CONTRACT SIGNBOARD FOR USE WHEN THE NYS PROGRAMME IS NOT REQUIRED:

Note: The “S’hamba Sonke” logo, as indicated below, shall appear on the signboard for Provincial Road Maintenance Grant (PRMG) contracts only. In all other cases it shall be omitted.

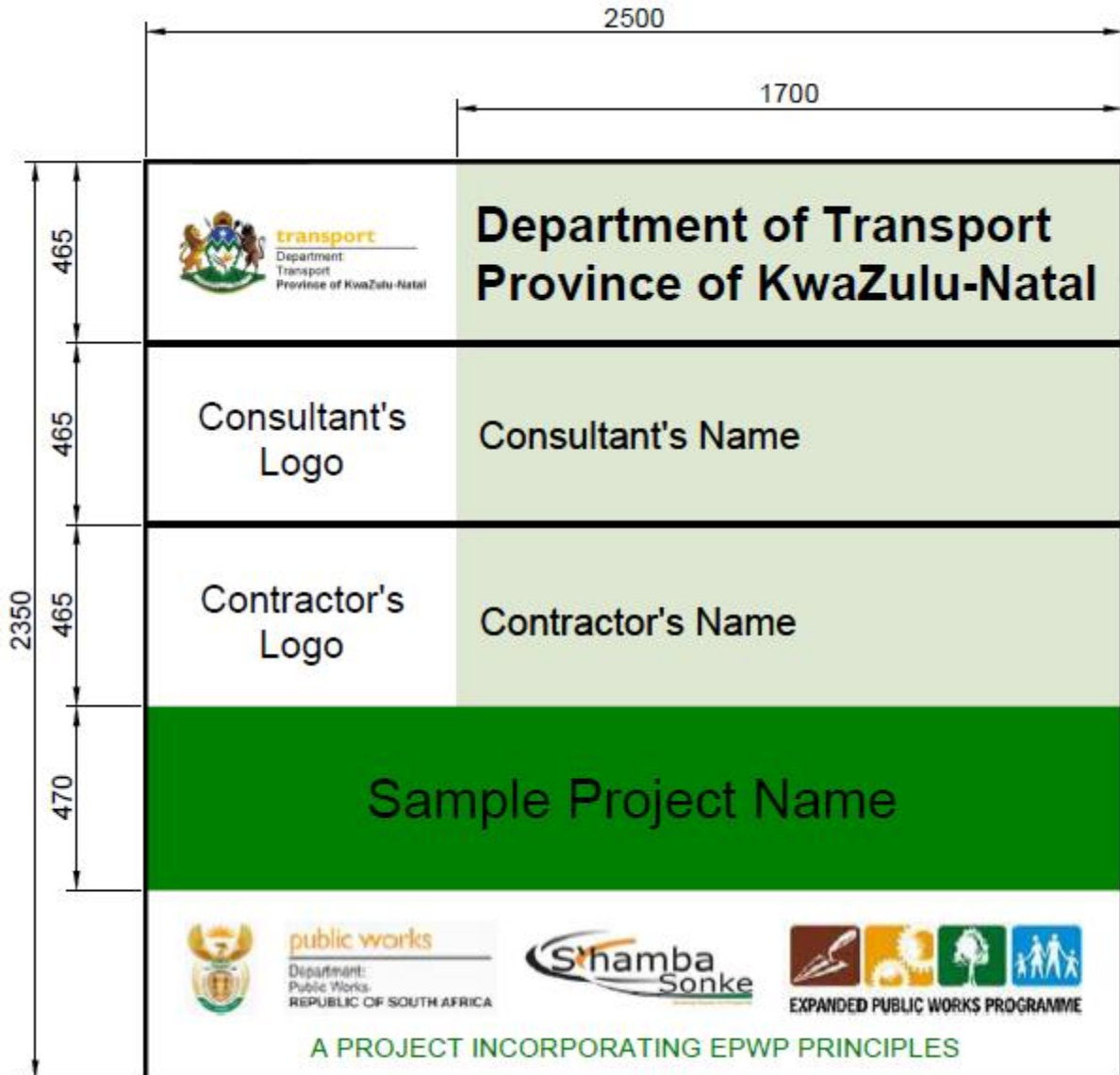

C4.2.2 CONTRACT SIGNBOARD FOR USE WHEN THE NYS PROGRAMME IS REQUIRED:

Note: The “S’hamba Sonke” logo, as indicated below, shall appear on the signboard for Provincial Road Maintenance Grant (PRMG) contracts only. In all other cases it shall be omitted.

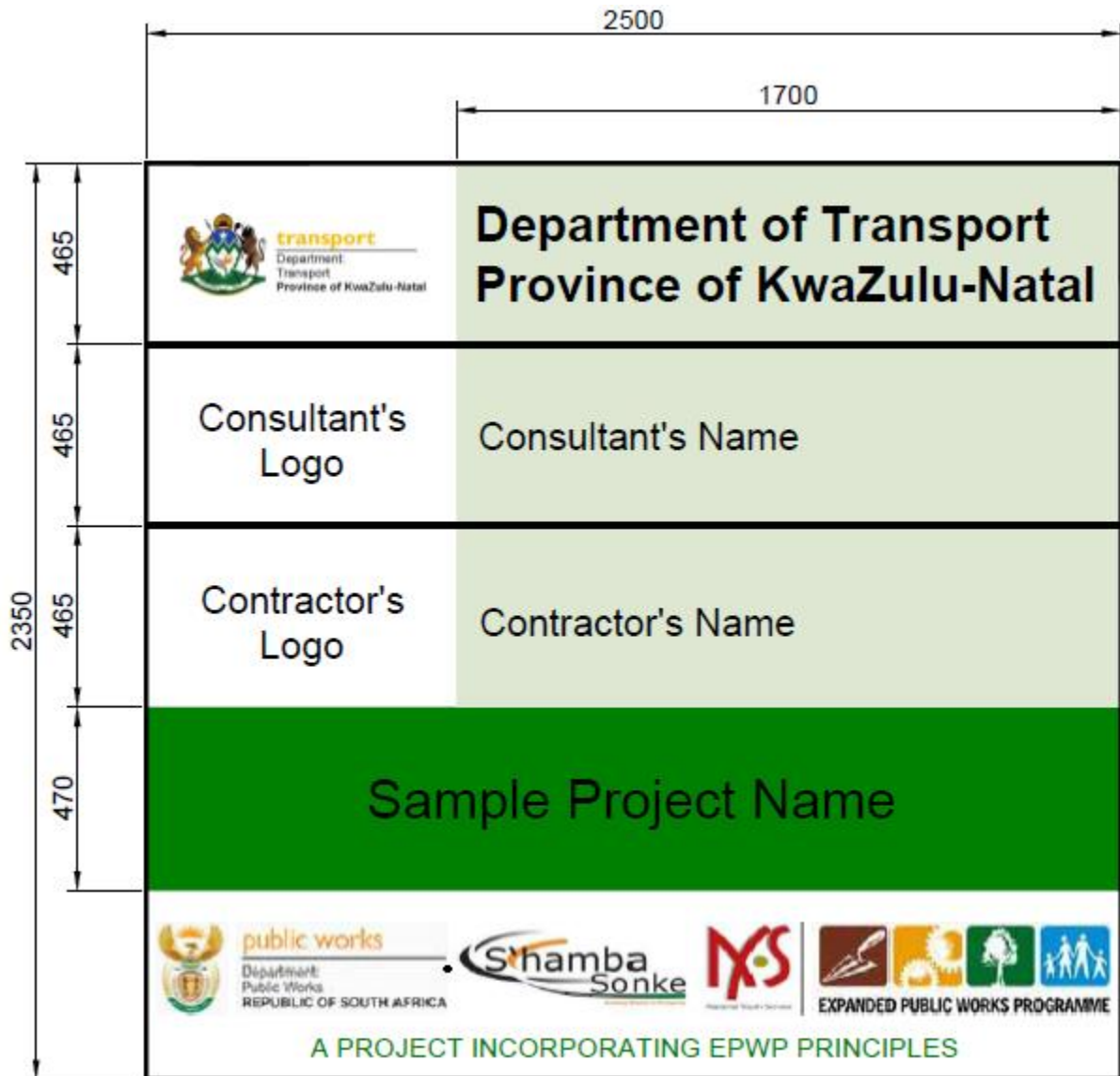

C4.3 EXISTING SERVICES REPORT

1. Location of services

Services are generally placed in the road reserve on the outside of the cuttings, and at the top of the fills. Currently along road alignments Telkom infrastructure, Eskom and UGU Water bulk lines are in a safe location. Once the actual construction commencement date is known, liaison with Telkom and Eskom will be initiated to determine if any infrastructure will need relocating.

Detailed services investigation was not part of this assessment. Contractors should assess services on appointment.

The known services on the site include:

- Eskom
- Telkom
- Ugu District Municipality

It is also expected that unknown buried domestic services crossings requiring relocation or protection may be encountered along the route as the work proceeds. The Contractor shall therefore make every effort to establish the location of any such unknown services in a particular area prior to excavations commencing in that area. Such efforts shall include the Contractor conducting a thorough visual surface inspection for services in the area, and also diligently enquiring of local landowners as to whether there are any known services which have not been shown on the drawings but which may be affected by the construction activities in that area, and any such services shall be brought to the attention of the Employer's Agent immediately. Exploratory hand excavation trenching work shall be carried out where necessary to establish the exact position of buried services.

The Contractor shall take note of the requirements of clause A1.2.3.13 of the standard specifications with regard to services.

2. Liaison with service owners

Immediately after the site has been handed over to the Contractor and prior to the commencement of any construction work on the site, the Contractor shall arrange a meeting with the relevant authorities to establish the exact location of the various services affected (if any), to plan the necessary services relocations (if required) and to obtain contact details for the service owners' technical and emergency staff.

Where services relocations are required, the Contractor shall arrange regular planning meetings with the service owners until such time as the services have been relocated and commissioned and the existing services uplifted and removed.

3. Protection of existing services

Prior to the commencement of any construction work on the site, the Contractor shall establish markers at 50 m centres (or closer where necessary), clearly delineating the routes traversed by the services within the road reserve as confirmed by the service owners.

Excavation operations shall commence only after the existing services within or in the near vicinity of the excavations have been suitably protected against damage.

The Contractor shall take particular care when carrying out blasting, pneumatic or mechanical breaking, and general excavation operations in the vicinity of the services, and subcontractors, foremen and plant operators shall be fully briefed on precautionary measures to be taken before excavation commences in these areas.

4. Relocation of services

Should any services need to be relocated, the Contractor shall be required to assist the service owner with programming, organising and carrying out the relocation work, in order to minimise any delays in the construction.

5. Payment for the services relocation work

A Provisional Sum has been provided under Section 2.1 of the bill of quantities to cover the costs of any protection, relocation, realignment, removal or replacement of services that may arise.

C4.4 CONDITIONS ON SITE: MATERIALS INFORMATION

CONTENTS	PAGE
C4.4.1 DISCLAIMER.....	C209
C4.4.2 GENERAL DESCRIPTION OF ROAD	C209
C4.4.3 BORROW PIT INVESTIGATION.....	C209
C4.4.4 MATERIALS FOR CONSTRUCTION	C209

C4.4.1 DISCLAIMER

The information in this document records the results of investigations done and various tests carried out on materials encountered in the existing road. The results are given in good faith and there is no warranty that the results are entirely representative of all the materials that may be encountered, the intention being to give an indication of the materials likely to be encountered.

No responsibility for any consequence arising from variation between the actual material properties and those indicated in this document will be accepted.

The specification and contract drawings shall always overrule this part of the contract documents.

C4.4.2 GENERAL DESCRIPTION OF ROAD

The network consists of paved and gravel roads with a nominal width between 6 to 8 metres.

C4.4.3 BORROW PIT INVESTIGATION

At time of contract award investigation into the material standard at borrow pit sources are to be investigated as well as mining licencing requirements.

C4.4.4 MATERIAL FOR CONSTRUCTION

C4.4.4.1 Selected subgrade and subbase layers

Not Applicable

C4.4.4.2 Crushed stone base

The G2 required for the construction of the crushed stone base shall be obtained from commercial sources.

C4.4.4.3 Concrete and surface seal aggregate, gabion stone and stone for erosion protection works

Crushed stone shall be obtained from commercial source.

C4.4.4.4 Natural sand

No specific source of sand was identified. The Contractor will have to make his own arrangements for the procurement of suitable sand for concrete, drainage and other construction purposes from commercial sources.

C4.4.4.5 Water

No specific source of water for construction purposes is identified. The Contractor will have to make his own arrangements in this regard. Water may be available from local rivers and streams but the Contractor will have to make suitable arrangements for access as required as well as for the necessary testing to prove its suitability.

C4.5 TRAFFIC INFORMATION

Signposting for this Contract

This is an extract for Traffic Signs Manual







Each Site needs to be carefully analysed to determine the extent and positions of signs. See Note 3 on page C213 are operating speeds

13.9.7 Reseal/Resurfacing Work - Just Completed

- Figure 13.48 illustrates recommended signing levels where work on resealing of a section of roadway has just been completed. This work activity may occur on sections of roadway within a larger site and may occur in more than one place at a time within such a site. When this is the case, the signing should be adjusted to suit the overall signing requirements of the site. Any temporary speed limit should relate to that operating within the rest of the site and should be as high as is practical and safe (see Section 13.4).
- Sign TW333 and sign TW338 should be considered when there is significant horizontal road curvature and/or the road crossfall or superelevation is also significant, as in hilly country, since the combination of loose stone chippings or dust on the road surface together with this type of road profile can lead to slippery conditions. Alternatively, sign TW333 may be used instead of sign TW338 if the condition of the road surface is considered to be a greater hazard than the risk of stone chippings being thrown up.
- The sign sequence shown should be repeated at approximately three kilometre intervals and, if the road is one carriageway of a dual carriageway road, the signs shall be repeated on the right, on the median island.
- A similar level of signing is appropriate if an asphalt overlay or concrete surface has just been laid and traffic is using it for the first time. With this type of surfacing the use of SURFACE STEP advance warning signs TW340 and TW341 may also be appropriate.
- If road markings are not likely to be re-marked shortly after re-opening the road to traffic, NO LINES advance warning signs should also be provided (see Volume 4, Chapter 3, Section 3.1).

Checklist

- is a 3 km spacing of sign sets adequate?
- is the road surface slippery?
- is there a temporary step in the road surface?
- will road markings be re-marked shortly after re-opening the road?

MAINTENANCE UNIT INVENTORY			
Sign	No	Size (mm)	Quantity
	TR201-60	1200	2 Plus 2 Every 3km
	TW338	1200	2 Plus 2 Every 3km
	R201-100	1200	2
	TW333	1200	2 Plus 2 Every 3km ⁽¹⁾
	TW340 TW341	1200	2 Plus 2 Every 3km ⁽²⁾
		1200	2 Plus 2 Every 3km ⁽³⁾
<p>(1) Add signs TW333 at 3km intervals if many sharp curves exist especially in mountain passes where loose gravel and crusher dust are located on the road surface.</p> <p>(2) Use signs TW340 / TW341 as appropriate in place of TW333 or TW338 when re-surfacing with asphalt overlay or concrete if a surface step is present.</p> <p>(3) Use text warning sign if repainting is not immediate.</p>			

NB See Subsection 13.9.7
for Sign Sizes.

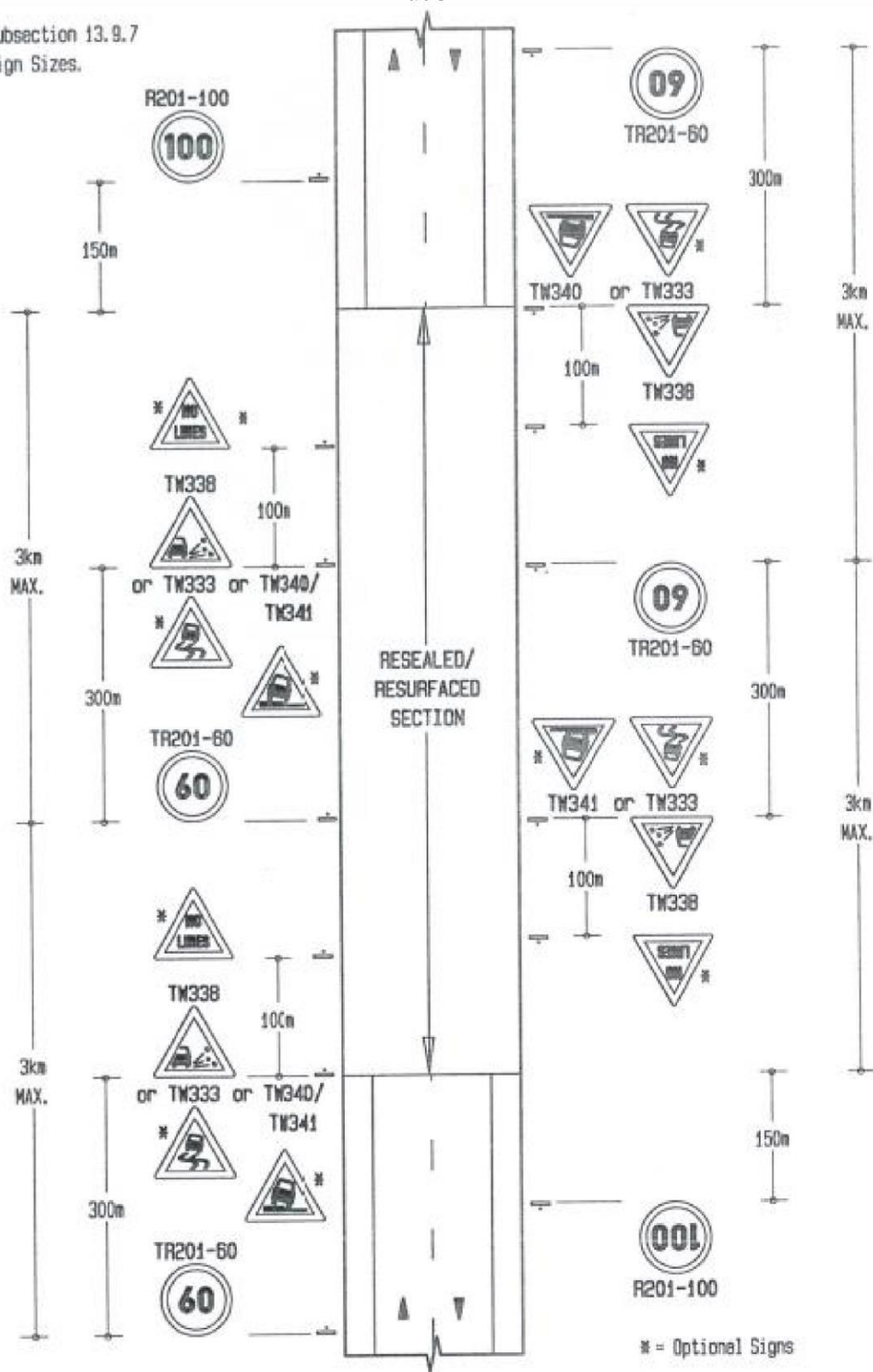









13.8.11 STOP/RY-GO Traffic Control-Minor Works

- 1 STOP/RY-GO operation may be required to control traffic at a variety of short term roadworks sites where the remaining roadway is reduced to less than two lanes in width, for whatever reason. As such, STOP/RY-GO traffic control is effectively a temporary signing sub-system. It may be used on its own or it may be used locally, in more than one place, for short periods within a long roadworks site. The detail in Figure 13.40 may therefore be incorporated with other short term applications and is particularly appropriate for urban areas.
- 2 The signing given in this detail is a minimised treatment for a very short term application lasting only one or two hours. For longer applications the signing should be upgraded to that covered by Subsection 13.9.3 and Figure 13.44. It should be considered as a daytime operation unless the site is very well illuminated at night. NO OVERTAKING signs TR214 should be carried by the maintenance unit and added to the illustrated sign sequence if required.
- 3 If operating speeds are in excess of 80 km/h additional speed limit signs TR201 should be displayed to reduce speed by a maximum of 20 km/h, or in 20 km/h increments to 80 km/h or 60 km/h as appropriate (see Section 13.4).
- 4 Flagmen must be well trained and shall operate in accordance with Figure 13.23. Whilst short term sites are likely to be short in length, if inter-visibility between flagmen cannot be guaranteed the flagmen should be equipped with two-way radios.
- 5 TRAFFIC CONE delineation devices TD4 and DE-LINEATOR PLATE hazard marker signs TW401/TW402 shall be spaced in accordance with Table 13.4 and all tapers shall conform to the provisions of Table 13.5. When cones are to be used during adverse light conditions, they shall be fitted with retroreflective sleeves. The mounting height of all signs shall be at least that given in Table 13.1 or higher. If the work unit's support vehicle is equipped with flashing yellow warning lights, it may benefit the safety of workers for the vehicle to be parked on the shoulder, at the work end of the approach Buffer Zone, between the workers and approaching traffic.

Checklist

- are operating speeds in excess of 80 km/h?
- do advance signs for the STOP/RY-GO control clash with other roadworks signs within the site?
- are the flagmen alert and well trained for their task?
- are the flagmen fully visible to oncoming traffic?
- are the flagmen standing in a safe position?
- can the restriction be eliminated to permit two-way traffic by dusk?

MAINTENANCE UNIT INVENTORY			
Sign	No	Size (mm)	Quantity
	TW336	1200	2
	TW343	1200	2
	R1.5A/ R1.5B	750	2
	TR103 TR104	1200	1 2
	TW411	300 X 1800	2
	FLAGS	450 X 450	2
	TD4	450 Min	20 Min. plus 10 per 100m site length
	TR214	1200	2
	TR201-80 AND TR201-60	1200	2 2

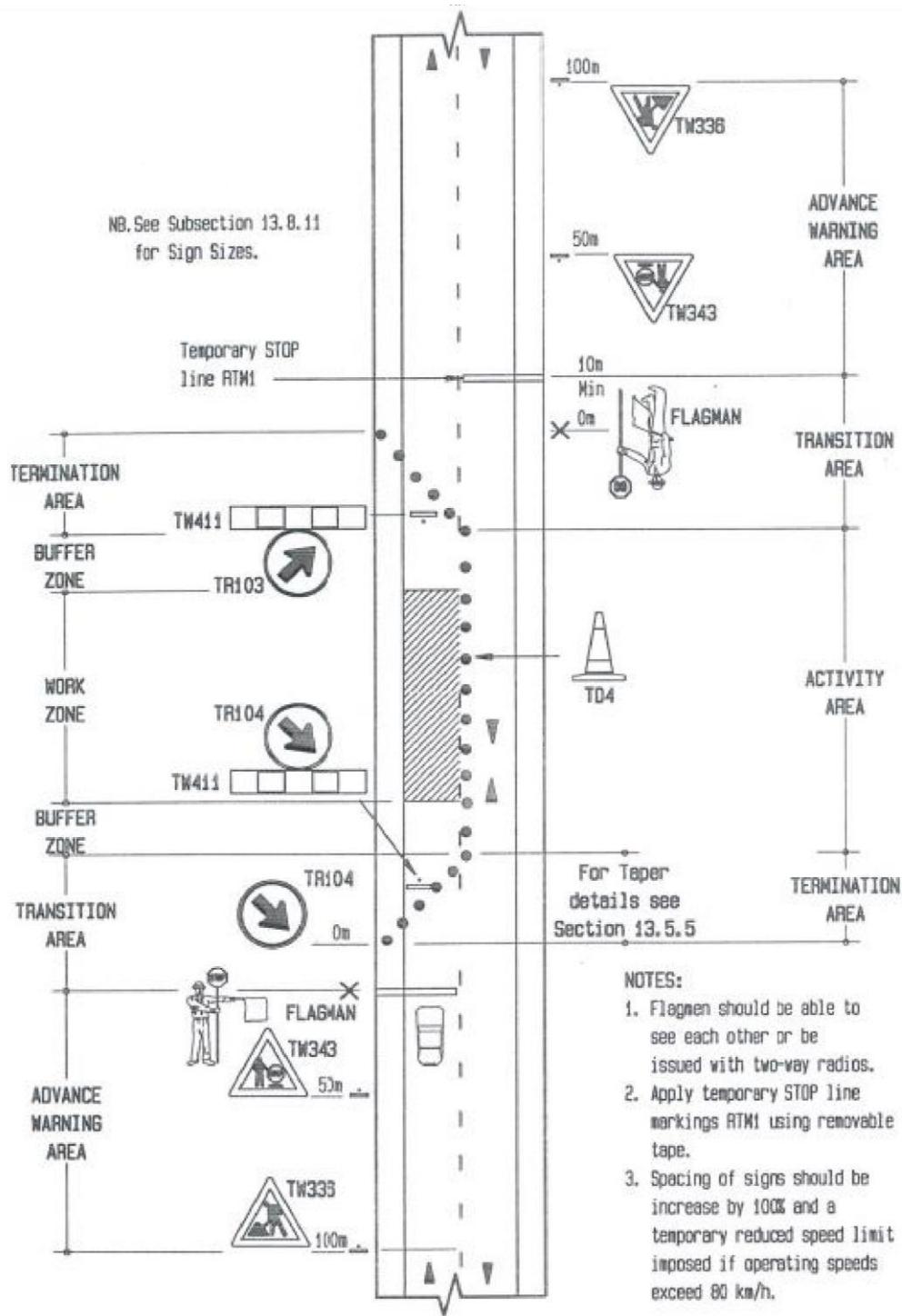

C4.6 STANDARD DETAILS
List of Drawings

	MISCELLANEOUS
SD 0101	Construction Board
	TYPICAL CROSS SECTIONS
SD 0201	Type 1A Rural Provincial Freeway
SD 0202	Type 1B Urban Provincial Freeway
SD 0203	Type 1C Urban Divided Arterial Road
SD 0204	Type 2A 4 Lane Undivided Arterial Road
SD 0205	Type 2B High Standard Primary Road
SD 0206	Type 2C Primary Road
SD 0207	Type 3 Secondary Road
SD 0208	Type 4 Low Standard Secondary or Tertiary Road
SD 0209	Type 5 Secondary or Tertiary Gravel Road
SD 0210	Type 6 District Gravel Road
SD 0211	Type 7A Local Gravel Road
SD 0212	Type 7B Local Gravel Road
	LAYOUTS
SD 0301	Setting Out Details - Type A1 Access
SD 0302	Setting Out Details - Type A2 Access (with painted refuge island)
SD 0303	Setting Out Details - Type B1 and B3 Accesses
SD 0304	Setting Out Details - Type B2 Access (with painted refuge island)
SD 0305	Setting Out Details - Bus Bay and Pedestrian Crossing Island
SD 0306	Setting Out Details - Type C Access
SD 0307	Road Surface Warning Devices
SD 0308	Typical Intersection of Major Roads
SD 0309	Kerbed Island Details
SD 0310	On Ramps
SD 0311	Off Ramps
SD 0312	Setting Out Details - Bus Bay (Concrete)
SD 0313	Typical Auxiliary Lane Transitions
	CROSS DRAINAGE ELEMENTS
SD 0401	Concrete Pipe Culvert Bedding
SD 0402	Pipe Culvert Headwalls (Concrete)
SD 0403	600 Dia. Pipe Culvert Headwalls (Gabion/Pitched)
SD 0404	Precast Concrete Portal Culvert Headwalls (Concrete)
SD 0405	Depressed Inlet
SD 0406	Pipe Culvert Headwalls (Masonry)
	CROSS DRAINAGE ELEMENTS CONTINUED
SD 0407	Precast Concrete Portal Culvert Headwalls (Masonry)
SD 0408	Dish Crossing (Pitched)
	SUBSOIL DRAINAGE
SD 0501	Road Edge Subsoil Drains
SD 0502	Cut Slope Subsoil Drains
	SURFACE DRAINAGE IN CUTTINGS
SD 0601	Side Drains

SD 0602	Side Drain and Grid Inlet
SD 0603	Side Drain Outlets
SD 0604	Mitre Chute
SD 0605	Pipe Chute, Open Chute and Catchwater Bank Details
SD 0606	Side Drain Bolster Details
	SURFACE DRAINAGE ON EMBANKMENTS
SD 0701	Kerb and Channel Drains
SD 0702	Drop Inlet and Grid Inlet Details
SD 0703	Side Inlet Details
SD 0704	Pipe to Open Chute
	SURFACE DRAINAGE (Other)
SD 0801	Median Drain and Grid Inlet Details
SD 0802	Urban/Peri-Urban Open Drainage Structures
	GABIONS AND MATTRESSES
SD 0901	Gabion Retaining Walls
	SERVICE DUCTS
SD 1001	Underground Service Crossings
SD 1002	Service Legends and Service Markers
SD 1003	Service Markers - Positioning and Structural Details
	GUARDRAILS AND BARRIERS
SD 1101	Guardrail Erection
SD 1102	Guardrail End Treatment
SD 1103	Median Barriers
SD 1104	Replacement Steel Handrail for Existing Narrow Bridges
	FENCING, GATES, CATTLE AND GAME GRIDS
SD 1201	Steel Supported Stockproof Fencing
SD 1202	Wooden Supported Stockproof Fencing
SD 1203	Concrete Supported Stockproof Fencing
SD 1204	Pedestrian Security Fencing (Diamond Mesh)
SD 1205	Pedestrian Security Fencing (Welded Mesh)
SD 1206	Cattle Grid (Metal) (for secondary and district roads)
SD 1207	Cattle Grid (Concrete) (for secondary and district roads)
SD 1208-1	Game Grid - General Layout
SD 1208-2	Game Grid - Concrete Details
SD 1208-3	Game Grid - Reinforcement Details
	ROAD SIGNS
SD 1301	Erection of Metal Signs on Creosoted Poles
SD 1302	Positioning of Signs
SD 1303	Signposting for Detours and Lane Closures
SD 1304	Signposting at Roadworks
SD 1305	Signposting for Mobile Maintenance Operations
	STRUCTURES
SD 1401	Standard Pipe Causeway (for rock foundation only)
SD 1402	Standard Portal Causeway (for rock foundation only)
	Concrete Pavement and Handrails
Con Detail	SMEC Concrete Pavement Layout
Handrails	SMEC Handrail Layouts

Concrete Pavement Drawing

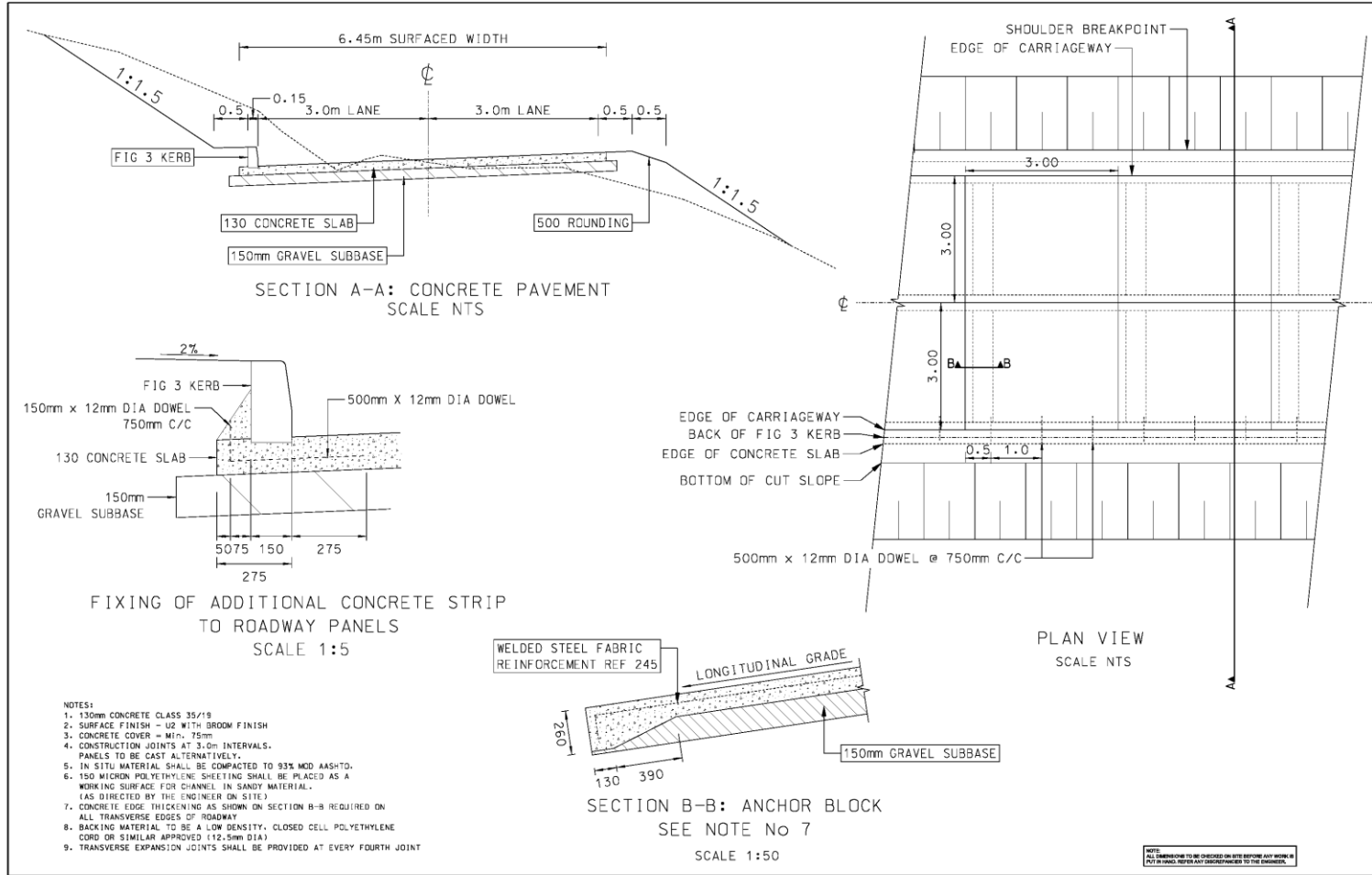

Contract No:	Contract Title:
Contract No.:	Contract Title:
Drawn By:	Checked By:
Approved By:	Scale:
Revision:	Date:



DATE: 15/08/2023

SCALE: 1:50

TYPICAL DETAIL : CONCRETE DETAIL

Drawn by:	Checked by:
Scale:	Date:

Polycrete Handrail Drawing

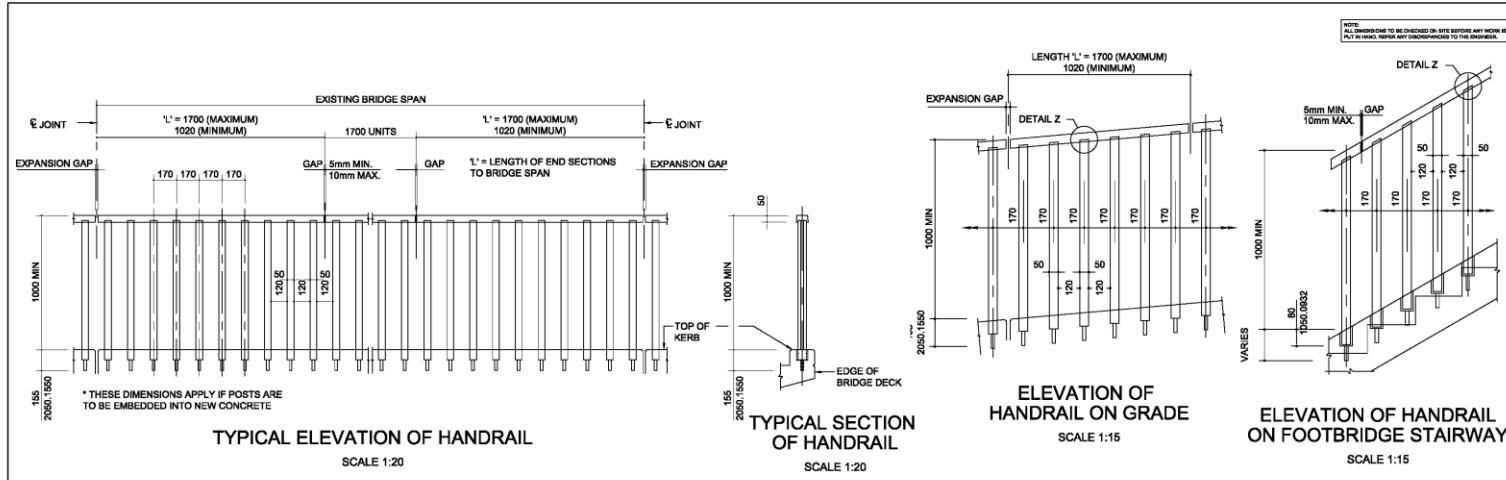

NOTE:

1. GENERAL

- 1.1 THE REQUIRED LENGTH OF THE HANDRAIL, THE LAYOUT AND THE REQUIRED UNIT QUANTITIES AND LENGTHS SHALL BE DETERMINED ON SITE.
- 1.2 HANDRAIL DESIGNED FOR LOADING ON PEDESTRIAN BARRIERS ACCORDING TO TMH 7, CLASS II (i.e. 4.5 kN/m VERTICALLY & 4.5 kN TRANSVERSE), ALSO TO BE USED FOR 1.5 kN/m LOAD CASE.

2.0 MATERIALS AND FINISHES

THE MATERIAL AND WORK SHALL COMPLY WITH THE RELEVANT CLAUSES OF SERIES 8000 AND 7000 OF THE STANDARD SPECIFICATIONS, THE PROJECT SPECIFICATIONS AND SHALL INCLUDE THE FOLLOWING:

2.1 CHARACTERISTIC STRENGTH OF MATERIALS:

2.1.1 REINFORCEMENT:

DESCRIPTION	CHARACTERISTIC STRENGTH (MPa)	CHARACTERISTIC YOUNG'S MODULUS (GPa)
MILD STEEL BARS	250	200

HIGH TENSILE STEEL	450	200
--------------------	-----	-----

2.1.2 FLAME RETARDANT POLYCRETE WITH UV STABILISER:

DESCRIPTION	CHARACTERISTIC STRENGTH (MPa)	CHARACTERISTIC TENSILE STRENGTH (GPa)	CHARACTERISTIC YOUNG'S MODULUS
PRECAST UNIT	250	70	200

2.2 SURFACE FINISHES: - CLASS F3 - STEEL SHUTTER FINISH
CLASS U3 - STEEL TROWEL FINISH

3. MANUFACTURE

- 3.1 THE PRECAST HANDRAIL UNITS SHALL CONFORM TO ALL DETAILS, INCLUDING DIMENSIONAL TOLERANCES SHOWN ON THE DRAWINGS.
- 3.2 THE SHUTTER RELEASE AGENT MUST NOT STAIN THE FINISHED PRODUCT. IT MUST BE CLEANED WITH A SOLVENT PRIOR TO APPLYING EPOXY ADHESIVE.
- 3.3 ALL REINFORCEMENT TO BE GALVANIZED IN ACCORDANCE WITH THE SPECIFICATIONS.

4. TOLERANCES

4.1 MANUFACTURING TOLERANCES:
THE MOULD SHALL BE MANUFACTURED TO TOLERANCES THAT WILL ENSURE THAT UNITS COMPLY WITH THE FOLLOWING TOLERANCES AFTER CASTING:

- 4.1.1 DIMENSIONS:
SECTIONAL DIMENSIONS : +5mm - 0mm
LENGTHS : +0mm - 5mm
- 4.1.2 SURFACE IRREGULARITIES AND WARP MEASURED BY MEANS OF A STRAIGHT EDGE:
VERTICAL : 2mm
HORIZONTAL : 3mm OVER THE LENGTH OF UNIT
- 4.1.3 SQUARENESS OF ENDS:
NO DIMENSION SHALL DEVIATE BY MORE THAN 2mm FROM THE THEORETICAL SQUARE PLANE CORRESPONDING TO THE FURTHEST PROJECTING POLYCRETE.

4.2. ERECTION TOLERANCE:

- 4.2.1 DIMENSIONS FROM SETTING OUT LINE TO FRONT FACE:
5mm OUTWARD, 0mm INWARD.
- 4.2.1 STEPS IN POLYCRETE FRONT FACES AND ABUTTING UNITS: 3mm
- 4.2.2 DEVIATION FROM LINE AND LEVEL MEASURED OVER ANY 5 UNITS: 5mm
- 4.2.3 POSTS SHALL ALWAYS BE FIXED VERTICAL IN THE CASE OF DECKS ON GRADE AND STEPS IN FOOTBRIDGES. THE ENGINEER TO ADVISE ON VERTICAL ALIGNMENT FOR ALL STRUCTURES ON VERTICAL CURVES.

5. ERECTION OF HANDRAIL UNITS

5.1 GENERAL:

- 5.1.1 NON-SHRINK CEMENTITIOUS GROUT AND EPOXY GROUT AS APPROVED BY THE ENGINEER.
- 5.1.2 NO UNIT SHALL BE TRANSPORTED OR ERECTED BEFORE IT HAS ATTAINED A CHARACTERISTIC STRENGTH OF 75MPa.
- 5.1.3 IN ORDER TO ACHIEVE GOOD ALIGNMENT WITH A UNIFORM APPEARANCE THE FOLLOWING PROCEDURE SHALL BE FOLLOWED FOR EACH INDIVIDUAL BRIDGE:
a) ONLY UNITS OF MATCHING COLOUR AND FINISH FROM ONE MOULD SHALL BE USED IN A PARTICULAR HANDRAIL.
b) LINING UP OF THE HANDRAIL UNITS SHALL BE COMPLETED OVER THE FULL LENGTH OF THE BRIDGE PRIOR TO FINAL GROUTING.
- 5.1.4 THE PREPARATION OF THE POLYCRETE SURFACES PRIOR TO THE PLACING AND GROUTING IN OF THE UNITS AND THE GROUTING OPERATION SHALL BE AS SPECIFIED IN THE PROJECT SPECIFICATIONS AND SHALL INCLUDE THE RECOMMENDATIONS OF THE GROUT MANUFACTURER.

5.2 ERECTION PROCEDURE:

- 5.2.1 ERECT TEMPORARY PROTECTION SCREEN.
- 5.2.2 REMOVE ANY EXISTING POSTS, BRACKETS AND PATCH BOLT HOLES, WHERE APPLICABLE.
- 5.2.3 DRILL 80 DIA. AND 18 DIA. HOLES INTO THE EXISTING KERB AS PER DETAIL.
- 5.2.4 PREPARE CONTACT SURFACES AS IN 5.1.4 ABOVE.
- 5.2.5 PLACE AND GROUT VERTICAL POSTS OF PRECAST UNITS AND ENSURE ALIGNMENT AS IN 4.2
- 5.2.6 GROUT AND FIX TO TOP RAIL.
- 5.2.7 REMOVE TEMPORARY PROTECTION SCREEN AFTER COMPLETION OF WORK.

LIST OF APPROVED MANUFACTURERS:

- 1. BRILLIANT BALUSTRADES - P.O. BOX 28 DURBAN 4000 (031) 700 5029

NO.	REVISION	DATE	DESCRIPTION	DESIGNED BY	CHECKED BY
1					

PROVINCE OF KWAZULU-NATAL
DEPARTMENT OF TRANSPORT

SMC
Member of the Sarsnet Group

DESIGNED BY: _____
CHECKED BY: _____
DATE: _____

TYPICAL DETAIL : POLYCRETE HANDRAIL

PEDESTRIAN PARAPET
PRECAST POLYCRETE
1,5&4,5kN/m DESIGN - DETAILS

SCALE: AS SHOWN

Polycrete Handrail Drawing

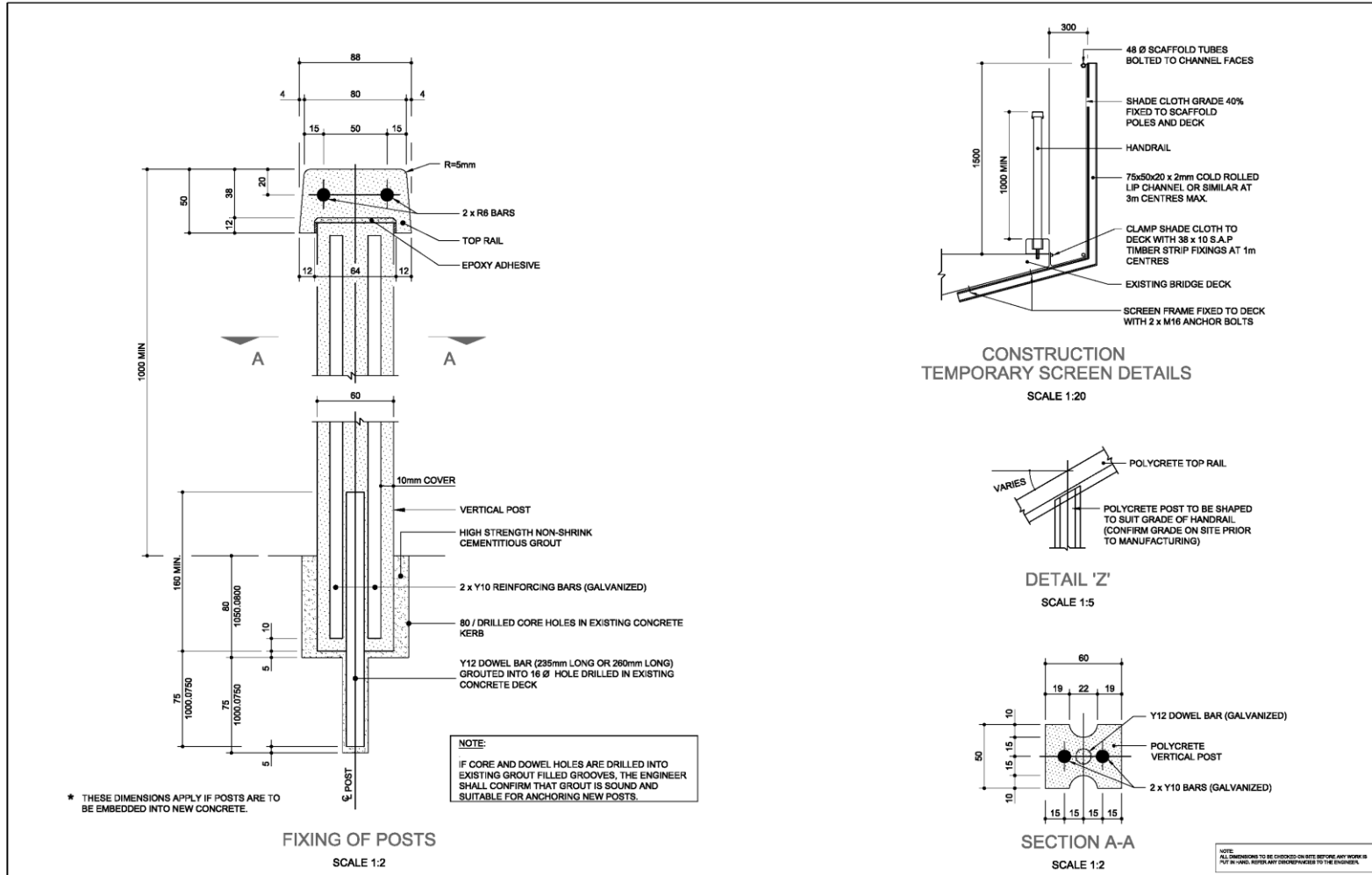

Vertical Date: _____ Checked Date: _____ Drawn Date: _____ Scale Section No: _____ Long/Short Section No: _____ Survey Plot No: _____		Design Date: _____ Checked Date: _____ Drawn Date: _____ Scale Section No: _____ Date of Approval: _____		 PROVINCE OF KWAZULU-NATAL DEPARTMENT OF TRANSPORT	 SMEC <small>Specialist Engineering & Construction</small> 2 The Corporate Centre, 10th Floor, 10000, 1000 17th Ave, 1000, Durban, South Africa 4001 Tel: +27 (0)31 2040000 Fax: +27 (0)31 2040000 Email: info@smec.co.za Website: www.smec.co.za	TYPICAL DETAIL : POLYCRETE DETAIL		Drawn by: AS/SM Scale: AS SHOWN	Sheet: _____ File No: _____
Date: 28/03/2024 Description: ORINA VERBOD Author: AK/SM		Date: _____ Description: _____ Author: _____				PEDESTRIAN PARAPET PRECAST POLYCRETE 1,5&4,5kN/m DESIGN- DETAILS		Drawn by: AS/SM Scale: AS SHOWN	Sheet: _____ File No: _____

C4.7 ANY OTHER RELEVANT TECHNICAL INFORMATION

NOT APPLICABLE

**ANNEXURE A: GUIDELINES FOR CONSTRUCTION
AND MAINTENANCE PROJECTS DURING COVID-19 LOCKDOWN**



transport

Department:

Transport

Province of KwaZulu-Natal

PROJECT SITE OCCUPATIONAL HEALTH AND SAFETY

GUIDELINES FOR CONSTRUCTION AND MAINTENANCE PROJECTS DURING COVID-19 LOCKDOWN

Revision 1/1 July 2020

Contents

1	INTRODUCTION	C224
1.1	BACKGROUND	C224
1.2	PURPOSE	C225
1.3	OBJECTIVES.....	C225
2	RISK ASSESSMENT	C225
2.1	BACK TO BASICS	C225
2.2	IMPLEMENTATION OF CONTROL MEASURES	C226
3	SITE OPERATING PROCEDURES	C227
3.1	SELF-ISOLATION.....	C227
3.2	IF SOMEONE FALLS ILL.....	C227
3.3	TRAVEL TO SITE	C227
3.4	SITE ACCESS POINTS	C228
3.5	HAND WASHING.....	C228
3.6	TOILET FACILITIES	C228
3.7	CANTEENS AND EATING ARRANGEMENTS	C228
3.8	CHANGING FACILITIES, SHOWERS AND DRYING ROOMS	C229
3.9	AVOIDING CLOSE WORKING	C229
3.10	GENERAL PRINCIPLES.....	C229
3.11	SITE MEETINGS	C229
3.12	CLEANING	C230
4	CONSTRUCTION PROTOCOLS.....	C230
4.1	PHYSICAL DISTANCING AND HYGIENE PROTOCOL	C231
4.2	SITE TRANSPORTATION PROTOCOL	C234
4.3	CLEANING PROTOCOL.....	C235
4.4	SCREENING AND MONITORING PROTOCOL	C237
	ACRONYMS.....	C238
	KEY TERMS & DEFINITIONS	C238
	APPENDIX A: SAFE PRACTICES ON SITE	C239
	APPENDIX B: SUSPECTED OR CONFIRMED CASE OF COVID-19.....	C240
	APPENDIX C: COVID-19 DAILY SYMPTOM MONITORING TOOL.....	C241
	APPENDIX D: COVID-19 BASELINE RISK ASSESSMENT	C242

Content of Figures

Figure 1: COVID-19 Alert Levels	224
Figure 2: Risk Exposures	225
Figure 3: Infection Control Strategies	226
Figure 4: Symptoms of COVID-19.....	227

1 INTRODUCTION

Coronavirus Disease 2019 (COVID-19) is a respiratory disease caused by the SARS-CoV-2 virus. In order to reduce the impact of COVID-19 on businesses, workers, customers and the public, the Kwazulu-Natal Department of Transport (KZNDOT), within the parameters of the COVID-19 regulatory framework, want to ensure that all those businesses, workers, customers and public it's interacting with are in compliance to the requirements as stipulated to ensure a safe work-environment for all.

On 23 April 2020, President Cyril Ramaphosa addressed the nation and announced that the country would resume economic activity in a phased approach from 1 May 2020. The lockdown levels depicted by Figure 1 below, will be lifted in phases, level 5 the highest and level 1 being the lowest as depicted below:

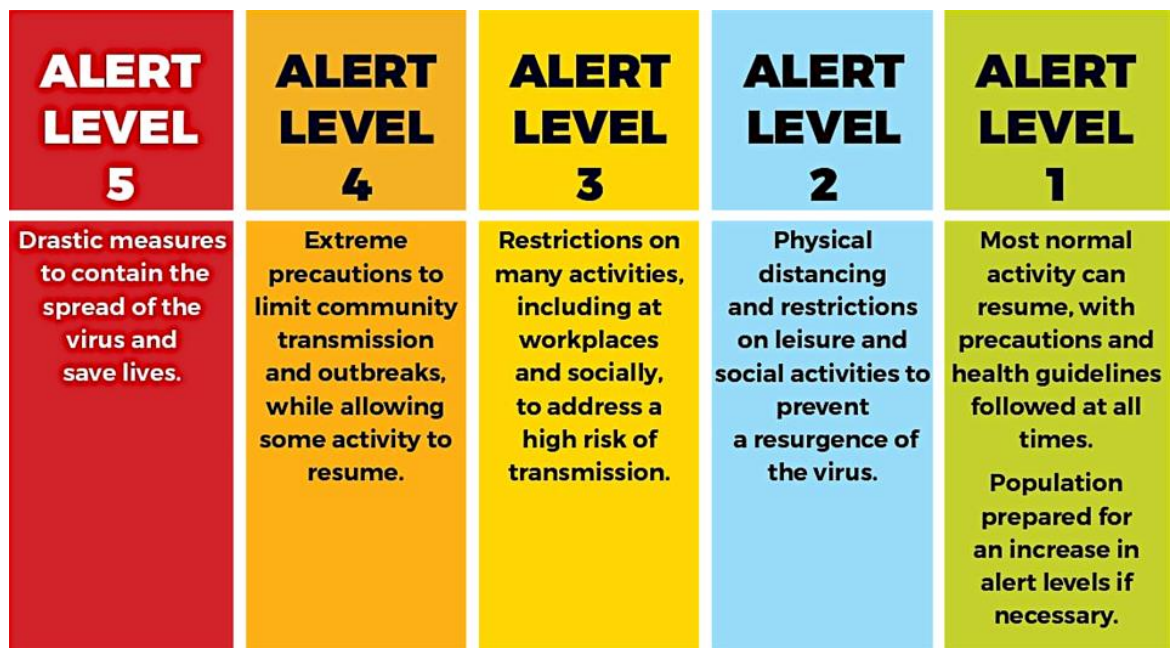

Figure 1: COVID-19 Alert Levels

1.1 BACKGROUND

Occupational Health and Safety are a fundamental segment of the construction industry. Safety must be embedded in all processes, implementing a top down approach, enabling the adoption of a safe and healthy working culture by all. Individual businesses or workplaces must have COVID-19 risk assessments and prevention and mitigation plans in place, and must conduct worker education on COVID-19 and protection measures:

- Identification and protection of vulnerable employees
- Safe transport of employees
- Screening of employees on entering the workplace
- Prevention of viral spread in the workplace
- Hand sanitisers and face masks
- Cleaning of surfaces and shared equipment
- Good ventilation
- Shift arrangements and canteen controls
- Managing sick employees

In addition to the above, monitoring systems must be in place to ensure compliance with safety protocols and to identify infections among employees.

1.2 PURPOSE

This document sets out the key principles and minimum requirements of the KZNDOT that define responsible, healthy and safe operations for road construction related operations working under COVID-19 Lockdown. The present state of the lockdown is geared toward the revival of economic activities and to allow employees involved in permitted services to resume work under certain conditions. This COVID-19 guidance has been developed on the basis of traditional infection prevention and occupational hygiene practices.

1.3 OBJECTIVES

The aims of this document are to:

- Keep workers and the wider public healthy and safe by preventing the spread of COVID-19.
- Apply relevant guidance from the Department of Health, Department of Employment and Labour and other Government Authorities to the construction environment.
- Encourage a safe and respectful work environment and good communication between all stakeholders.
- Sit alongside existing health and safety controls to ensure workers are safe on site.

Contractors and their employees should use this guidance to help identify risk levels on construction sites and to identify any appropriate control measures to be implemented. Additional guidance may be needed as the conditions of the COVID-19 outbreak change and as new information about the virus, its transmission and impact become available. It focuses on, as well as considerations for, the need for contractors to implement engineering, administrative and work practice controls and personal protective equipment (PPE).

2 RISK ASSESSMENT

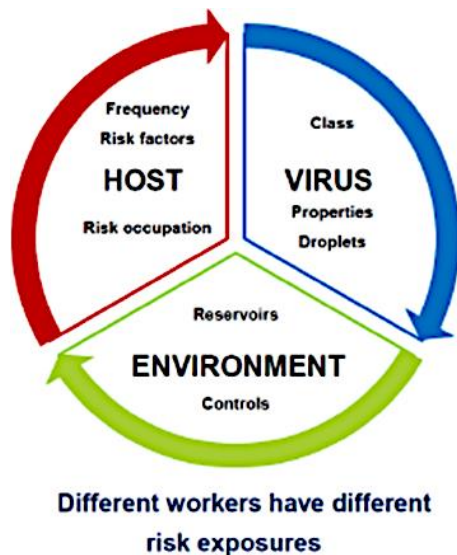

Figure 2: Risk Exposures

The legislation governing workplaces in relation to COVID –19 is the Occupational Health and Safety Act, Act 85 of 1993, as amended, and with the Hazardous Biological Agents Regulations and the Construction Regulation 2014. Section 8(1) of the Occupational Health and Safety Act, Act 85 of 1993, as amended, requires the employer to provide and maintain a working environment that is, to the extent possible reasonably practicable, as amended. Specifically, Section 8(2)(b) requires steps that may be reasonably practicable to eliminate or mitigate any hazard or potential hazard prior to the use of personal protective equipment (PPE).

2.1 BACK TO BASICS

Risk Assessment should be done to determine the **RISK** of **EXPOSURE** and to communicate this to the **WORKERS**.

2.2 IMPLEMENTATION OF CONTROL MEASURES

Before the implementation of control measures, current risk assessments need to be reviewed and updated, taking into account the new hazards posed by exposure to COVID-19 in the workplace. This is in accordance with Section 8 (2) (d) of the OHS Act.

With COVID-19, it may not be possible to eliminate the hazard, the most effective protection measures are engineering controls, administrative controls, safe work practices (a type of administrative control), and Personal Protection Equipment.

Measures for protecting workers from exposure to, and infection with, SARS-CoV-2, the virus that causes Coronavirus Disease 2019 (COVID-19), depend on the type of work being performed and exposure risk, including potential for interaction with people with suspected or confirmed COVID-19 and contamination of the work environment.

Contractors should adapt infection control strategies based on a thorough hazard assessment, using appropriate combinations of engineering and administrative controls, safe work practices, and personal protective equipment (PPE) to prevent worker exposures.

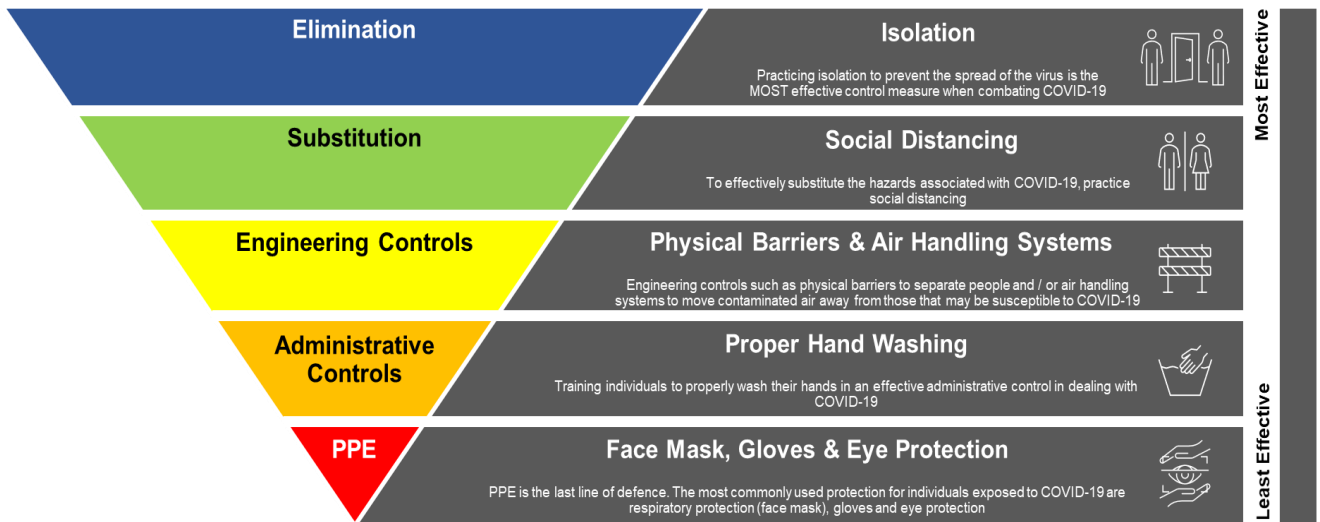

Figure 3: Infection Control Strategies

In preventing occupational exposure to COVID-19 also require Contractors to train workers on elements of infection prevention, including PPE. This would assist Contractors to identify:

- Exposure Levels
- “High Contact” Activities, and
- Vulnerable Workers and Special Measures

Contractors are expected to undertake and champion the principles of constantly focussing on eliminating or reducing the risk of COVID-19 transmission to an acceptable level, engaging meaningfully with their workforce, and making worker health a key priority. A Baseline Risk Assessment is included under Appendix D: COVID-19 Baseline Risk Assessment.

3 SITE OPERATING PROCEDURES

KZNDOT Construction sites operating during the Covid-19 pandemic need to ensure that they protect their workforce and minimise the risk of infection spread. In line with government guidelines on social distancing, this guideline is intended to implement effective steps at all KZNDOT construction sites of any size. These are extraordinary situations, and the KZNDOT intends to abide to the latest COVID-19 advice from national government.

3.1 SELF-ISOLATION

Anyone who meets one of the following criteria should not come to site:

- Has a high temperature or a new persistent cough;
- Is a vulnerable person (by virtue of their age, underlying health condition, clinical condition or pregnancy); or
- Is living with someone in self-isolation or with a vulnerable person.

3.2 IF SOMEONE FALLS ILL

If a worker develops a high temperature or a persistent cough while at work, they should:

- Return home immediately;
- Avoid touching anything; and
- Cough or sneeze into a tissue and put it in a bin, or if they do not have tissues, cough and sneeze into the crook or into the bent elbow.

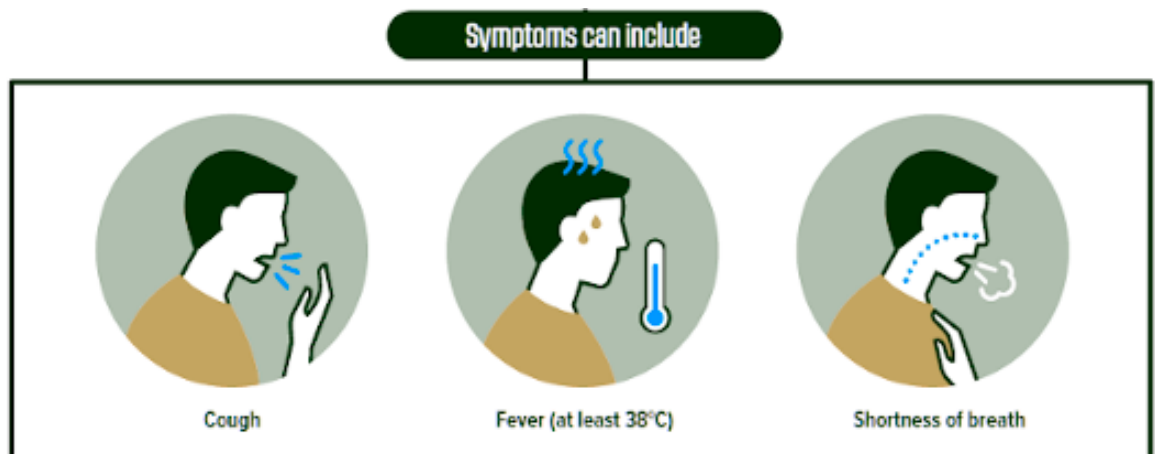

Figure 4: Symptoms of COVID-19

They must self-isolate and not return to work until their period of self-isolation has been completed and his or her negative status has been confirmed.

3.3 TRAVEL TO SITE

Wherever possible workers should travel to site alone using their own transport, and construction sites need to consider:

- Parking arrangements for additional cars, taxis, buses, etc;
- Other means of transport to avoid public transport e.g. cycling;
- They must ensure disinfecting the alternative transport before and after use; and Public Transport Regulations in respect of COVID-19 are adhered to;

- Providing hand cleaning facilities at entrances and exits. This should be soap, water and paper towels (and not fabric towels) wherever possible or hand sanitiser if water is not available; and
- How someone detected vulnerable after screening, taken ill and would get transported home.

3.4 SITE ACCESS POINTS

- Stop all non-essential visitors
- People, be it workers or visitors, without relevant face masks should not be allowed to enter construction sites; and workers should wear face masks at all times.
- Introduce staggered start and finish times to reduce congestion and contact at all times
- Monitor site access points to enable social distancing – you may need to change the number of access points, either increase to reduce congestion or decrease to enable monitoring
- Remove or disable entry systems that require skin contact e.g. fingerprint scanners
- Require all workers to wash or clean their hands before entering or leaving the site or as frequent as possible
- Allow plenty of space (two metres) between people waiting to enter site
- Regularly clean common contact surfaces in Site Office, Access Control and delivery areas e.g. scanners, turnstiles, screens, telephone handsets, desks, particularly during peak flow times
- Reduce the number of people in attendance at site inductions and consider holding them outdoors wherever possible
- Drivers should remain in their vehicles if the load will allow it and must wash or clean their hands before unloading goods and materials.

3.5 HAND WASHING

- Provide additional hand washing facilities to the usual welfare facilities on a large spread out site or significant numbers of personnel on site
- Ensure soap, fresh water and paper towels is always readily available and kept topped up
- Provide hand sanitiser where hand washing facilities are unavailable
- Regularly clean the hand washing facilities and check soap and sanitiser levels
- Provide suitable and enough rubbish bins for hand paper towels with regular removal and disposal.
- Sites will need extra supplies of soap, hand sanitiser and paper towels and these should be securely stored.

3.6 TOILET FACILITIES

- Restrict the number of people using toilet facilities at any one time e.g. use a welfare attendant
- Wash hands before and after using the facilities
- Enhance the cleaning regimes for toilet facilities particularly door handles, locks and the toilet flush handles or buttons
- Portable toilets should be avoided wherever possible, but where in use these should be cleaned and emptied more frequently
- Provide suitable and sufficient rubbish bins for hand towels with regular removal and disposal.

3.7 CANTEENS AND EATING ARRANGEMENTS

Whilst there is a requirement for construction sites to provide a means of heating food and making hot drinks, these are exceptional circumstances and where it is not possible to introduce a means of keeping equipment clean between use, kettles, microwaves etc. must be removed from use.

The workforce should also be required to stay on site once they have entered it and not use local shops.

- Dedicated eating areas should be identified on site to reduce food waste and contamination
- Break times should always be staggered to reduce congestion and contact
- Hand cleaning facilities or hand sanitiser should be available at the entrance of any room where people eat and should be used by workers when entering and leaving the area
- The workforce should be asked to bring pre-prepared meals and refillable drinking bottles from home
- Workers should sit 2 metres apart from each other whilst eating and avoid all contact
- Where catering is provided on site, it should provide pre-prepared and wrapped food only
- Crockery, eating utensils, cups etc. should not be used
- Drinking water should be provided with enhanced cleaning measures of the tap mechanism introduced
- Tables should be cleaned between each use
- All rubbish should be put straight in the bin and not left for someone else to clear up
- All areas used for eating must be thoroughly cleaned at the end of each break and shift, including chairs, door handles, vending machines and payment devices.

3.8 CHANGING FACILITIES, SHOWERS AND DRYING ROOMS

- Always introduce staggered start and finish times to reduce congestion and contact
- Introduce enhanced cleaning of all facilities throughout the day and at the end of each day
- Consider increasing the number or size of facilities available on site if possible
- Based on the size of each facility, determine how many people can use it at any one time to maintain a distance of 1 ½ metres
- Provide suitable and enough rubbish bins in these areas with regular removal and disposal.

3.9 AVOIDING CLOSE WORKING

There will be situations where it is not possible or safe for workers to distance themselves from each other by 1.5 metres.

3.10 GENERAL PRINCIPLES

- Non-essential physical work that requires close contact between workers should not be carried out
- Work requiring skin to skin contact should not be carried out
- Plan all other work to minimise contact between workers
- Re-usable PPE should be thoroughly cleaned after use and not shared between workers
- Single use PPE should be disposed of so that it cannot be reused
- Stairs should be used in preference to lifts or hoists
- Where lifts or hoists must be used:
 - Always lower their capacity to reduce congestion and contact
 - Regularly clean touchpoints, doors, buttons etc.
- Increase ventilation in enclosed spaces
- Regularly clean the inside of vehicle cabs and between use by different operators.

3.11 SITE MEETINGS

- Only absolutely necessary meeting participants should attend
- Attendees should be two metres apart from each other
- Rooms should be well ventilated / windows opened to allow fresh air circulation
- Consider holding meetings in open areas where possible.

3.12 CLEANING

Enhanced cleaning procedures should be in place across the site, particularly in communal areas and at touch points including:

- Taps and washing facilities
- Toilet flush and seats
- Door handles and push plates
- Handrails on staircases and corridors
- Lift and hoist controls
- Machinery and equipment controls
- Food preparation and eating surfaces
- Telephone equipment
- Keyboards, photocopiers and other office equipment

Rubbish collection and storage points should be increased and emptied regularly throughout and at the end of each day.

4 CONSTRUCTION PROTOCOLS

The core principle behind this “Construction Protocols” is to protect the health and safety of all workers required to perform duties during the COVID-19 crisis, including related health and safety impacts on operations related to operating under a COVID-19 environment, as well as protecting the wider KwaZulu-Natal population from transmission and spread of the virus.



Before
arriving on
Site

- Each Contractor must have a plan detailing the steps they will take to mitigate risks, including those presented by COVID-19. The details of the plan must be communicated to workers before they start work.
- Before any activity is recommenced the Contractor must ensure that all hazards have been reviewed and appropriately controlled before work activity is commenced after lockdown.
- Where possible, conduct a remote induction before arrival on site, this can be done via video conferencing or by phone.
- If an in-person induction is required, the **Physical Distancing and Hygiene Protocol** must be followed.
- All workers shall undergo a screening process to ensure they are fit for duty by confirming their health status.
- Contractors must understand how workers will travel to and from site and will communicate the **Site Transportation Protocol** to all.
- Ensure all workers understand when additional PPE may be required due to COVID-19 and that workers have access to the correct PPE as per the Department of Employment and Labour guidelines. When required to use face masks or gloves please follow these processes.

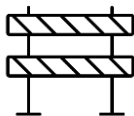

Site Entry

- Only relevant personnel to the workplace are to access the site.
- All office employees supporting a project will work remotely, where possible.
- A daily register of workers entering and leaving site must be completed along with a health declaration. Use your existing sign in register or the example Sign-in register.
- Signage reminding workers of the COVID-19 **Physical Distancing and Hygiene Protocol** will be posted at the site entrance and in common areas where appropriate.



Site Operations

- All work is to be undertaken in such a way as to reduce any possible contact between workers and to promote physical distancing wherever possible, as per the **Physical Distancing and Hygiene Protocol**.
- All visitors to the site, such as necessary delivery workers, will be restricted to one person wherever possible. These workers must follow the **Site Transportation Protocol**.
- All offices and jobsites must implement cleaning measures as per the **Cleaning Protocol**.
- All tools, equipment, plant and vehicles must be used in alignment with the **Cleaning Protocol**.
- Toolbox talks should be held with physical distancing in place as per the **Physical Distancing and Hygiene Protocol**.
- Additional sanitary measures are to be implemented on site to prevent the spread of COVID-19 e.g. hand washing stations, provision of additional hand sanitizer, provision of disinfectant wiping products, as per the **Physical Distancing and Hygiene Protocol**.
- Smokers must follow the **Physical Distancing and Hygiene Protocol**.
- A COVID-19 Response plan must be available and accessible on site.



Leaving Site

- Workers must use the sign-in register to sign out.
- When returning home, workers will need to follow the necessary hygiene measures.
- Each site must be cleaned and sanitised at the end of the working day or end of each shift, as per the **Cleaning Protocol**.
- All waste and disposable PPE must be removed from site and securely disposed of as per the **Cleaning Protocol**.
- Workers must follow the **Site Transportation Protocol**.

4.1 PHYSICAL DISTANCING AND HYGIENE PROTOCOL

Physical distancing, also known as “social distancing”, is about keeping a safe distance from others. For physical distancing, at least one and ½ metre’s separation is required at work, and two metres in uncontrolled environments, like in public. This aligns with World Health Organisation advice. We expect one and ½ metre’s separation between people at work as the minimum and greater separation where it is reasonably practicable to do so. This is important to help protect us from COVID-19, which spreads via droplets from coughing and sneezing.

General Working Arrangements

- Keep team sizes as small as possible.
- Keep a record of who is in each team every day as it is required to assist contact tracing.
- Site teams are encouraged to put forward split/alternating shifts to avoid extensive intermingling to reduce potential of exposure.
- Work site is always to be segregated into zones (or by other methods) as much as possible to keep different teams/trades physically separated.
- Where possible, a one-way system in high-traffic areas, such as lifts, stairwells and scaffolds (Where Applicable).
- Where practical, all office employees supporting a project, work remotely.
- When using a vehicle, the **Cleaning Protocol** needs to be followed.
- When using a vehicle, limit this to one/two person per vehicle if possible.













External Interfaces	<ul style="list-style-type: none">• One member of the crew nominated to receive supplies etc.• Keep the engagement with the other person as brief as possible and maintain a two-metre physical distance.• Ask for paperwork to be emailed rather than handed over as much as possible.• If unavoidable, then either wear gloves when handling the item or wash hands before and after handling said items.
Site Entry	<ul style="list-style-type: none">• Limit visitors to site wherever possible.• Introduce staggered start and finish times where possible to reduce congestion and contact.• Monitor site access points to enable physical distancing – you may need to change the number of access points, increase to reduce congestion or decrease to enable monitoring.• Where entry systems that require skin contact, the Cleaning Guide must be followed.• Require all workers to wash or clean their hands before entering and leaving the site.• Allow plenty of space 1½ metres between people waiting to enter site.• Regularly clean common contact surfaces in reception, office, access control and delivery areas e.g. scanners, turnstiles, screens, telephone handsets, desks, particularly during peak flow times.• Where possible, conduct a remote induction before arrival on site, this can be done via video conferencing or by phone. If an in-person induction is required, reduce the number of people and hold them outdoors wherever possible.• Delivery drivers should remain in their vehicles if the load will allow it and must wash or clean their hands before unloading goods and materials.• Any sign in registers should be recorded by one person where possible – do not pass material around the group and minimise contact with any screens.
Site Meetings	<ul style="list-style-type: none">• Only absolutely necessary meeting participants should attend.• Attendees should be two metres apart from each other• Rooms should be well ventilated / windows opened to allow fresh air circulation.• Hold meetings in open areas where possible.• Meetings are to be held through teleconferencing or videoconferencing where possible.
Avoiding Close Working	<ul style="list-style-type: none">• Risk assessments and method statements must be updated to include COVID-19 control measures.• At least 1½ metre's separation is required at work. KZNDOT expect 1½ metre separation between people at work as the minimum and greater separation where it is reasonably practicable to do so.• If it is not possible or safe for workers to distance themselves by one metre for a work activity, the works should not be carried out.• Re-usable PPE should be thoroughly cleaned after use and not shared between workers.• Single use PPE should be disposed of so that it cannot be reused.• Stairs should be used in preference to lifts or hoists.• Where lifts or hoists must be used:• Lower their capacity to reduce congestion.• Regularly clean touchpoints, doors, buttons etc.• Increase ventilation in enclosed spaces

Toilet Facilities	<ul style="list-style-type: none">• Physical distancing rules apply to the use of shared facilities, including toilets.• Wash hands before and after using the facilities.• Enhance the cleaning regimes for toilet facilities particularly door handles, locks, toilet flush and sanitary bins.• Provide suitable and sufficient rubbish bins for hand towels with regular removal and disposal.
Eating Measures	<ul style="list-style-type: none">• If you need to leave site for any reason, follow site entry procedures on return.• Dedicated eating areas should be identified on site to reduce food waste and contamination.• Break times should be staggered to reduce congestion and contact at all times.• Hand cleaning facilities or hand sanitiser should be available at the entrance of any room where people eat and should be used by workers when entering and leaving the area.• The workforce should be asked to bring pre-prepared meals and refillable drinking bottles from home.• Workers should sit 2 metres apart from each other whilst eating and avoid all contact.• Where catering is provided on site, it should provide pre-prepared and wrapped food only.• Shared crockery, eating utensils, cups etc. should not be used.• Tables should be cleaned between each use.• All rubbish should be put straight in the bin and not left for someone else to clear up.• All areas used for eating must be thoroughly cleaned at the end of each break and shift, including chairs, door handles.• Limit access and use of water fountains.• Consider numbers on site for site facilities as physical distancing may require additional space/facilities.
Changing Facilities, Showers and Drying Rooms	<ul style="list-style-type: none">• Introduce staggered start and finish times to reduce congestion and contact at all times.• Introduce enhanced cleaning of all facilities throughout the day and at the end of each day.• Consider increasing the number or size of facilities available on site if possible.• Based on the size of each facility, determine how many people can use it at any one time to maintain a distance of one metre.• Provide suitable and sufficient rubbish bins in these areas with regular removal and disposal.
General Hygiene	<ul style="list-style-type: none">• Each worker must sanitise their hands with hand sanitiser or soap and running water before entry onto site, use warm water if available.• Set up a specific place near the entry of the site for handwashing and/ or sanitising.• Any personal items brought to site by workers must be segregated (kept separate from other workers items).• Individual PPE for workers must be kept separate from other workers PPE and cleaned correctly as per the Cleaning Protocol.• All eating and drinking utensils to be cleaned by the user. Have paper towels accessible to dry.
Smoking	<ul style="list-style-type: none">• Smokers/vapers must use designated area or do so off-site and butts are to be placed in the designated receptacle. Hands must be washed before and after smoking.• Stand so that smoke or vapor produced is not going into another person's breathing zone.

- | | |
|--------------|--|
| Hand Washing | <ul style="list-style-type: none"> • Provide additional hand washing facilities to the usual welfare facilities on large, spread out sites or significant numbers of personnel on site. • Ensure soap and fresh water is readily available and kept topped up at all times. • Provide hand sanitiser where hand washing facilities are unavailable. • Regularly clean the hand washing facilities and check soap and sanitiser levels. • Sites will need extra supplies of soap, hand sanitiser and paper towels and these should be securely stored. |
|--------------|--|

4.2 SITE TRANSPORTATION PROTOCOL

Employers are required to have an understanding of how workers will travel to and from site.

Workers travel to site		Workers are to travel to the site one person per vehicle where possible.
		Log is to be kept recording who has arrived on site, how they travelled and who they travelled with for contact tracing purposes.
		Workers must travel home in the same vehicle as they arrived in.
		Handwashing protocols to be observed before entering site.
Any travel managed by the employer should ensure that adequate steps can be achieved for this transport which includes:		Allowing for spaces between passengers.
		Hygienic washing of hands before and after the journey.
		Follow Vehicle Cleaning Procedures as per the Cleaning Protocols.
		Restricting equipment and baggage to trailers and or separate parts of the vehicle.
Deliveries to site		Deliveries to site should be delivered by one person only where possible.
		Handwashing protocols to be observed once arrived at site.
		Sign-in register must be completed for persons delivering goods to site.
		1,5 m physical distancing rules to be applied at all times.

4.3 CLEANING PROTOCOL

Construction Sites operating under Coronavirus COVID-19 Lockdown need to ensure they are protecting their workforce and minimising the risk of spread of infection.

Key Cleaning Tips

All construction sites (offices and jobsites included) should implement additional cleaning measures of common areas to help minimise the spread of COVID-19. Consider your work environment and what is frequently used and touched by workers, customers and others. The virus can be spread from person to person or by touching unclean equipment or surfaces. To stop the spread, focus efforts on cleaning areas where the virus is more likely to spread, such as the kitchen and toilet.

- Schedule regular cleaning.
- Use a suitable cleaning product.
- Use disposable cloths, if available.
- Always wear disposable gloves when cleaning. When finished, place used gloves in a rubbish bin.
- Wear disposable gloves while handling soiled items.
- Wash hands immediately after removing gloves or after handling these items.

Physical distancing should also be practiced when cleaning offices and jobsites. Refer to the **Physical Distancing and Hygiene Protocol** for more information.

Disinfecting Cleaning Aids

Cleaning aids, such as cloths or mops, must be germ-free or they'll spread germs to other surfaces. To help prevent the spread of germs:

- Use disposable cloths or paper towels when possible.
- Reusable cloths should be disinfected or washed after each use.
- Wash brushes in a dishwasher regularly or clean with detergent and warm water after each use.
- Use two buckets for mopping - one for detergent and the other for rinsing.
- Mops and buckets should be cleaned and dried after each use.

Site Cleaning

Before leaving the jobsite at the end of the working day or end of each shift, wipe down any tables/surfaces with soapy water or cleaning agents where possible. All workers must be checked out of site and record kept daily.

Common touch points may include:

- All waste and disposable PPE must be securely disposed of.
- All door handles, railings and personal workstation areas are wiped down with a disinfectant, such as disinfectant wipes. Individuals are responsible for cleaning their workstation area with disinfectant wipes.
- Clean all 'high-touch' surfaces such as desks, counters, tabletops, doorknobs, bathroom fixtures, toilets, light switches, phones, and keyboards every day with antiseptic wipes or disinfectant, including bleach solutions.

Cleaning Bathrooms, Toilets and Showers	<p>Clean toilets with a separate set of cleaning equipment (disposable cleaning cloths, mops, etc).</p> <p>Clean sinks frequently if they're used regularly. If your jobsite has a shower:</p> <ul style="list-style-type: none">• Clean shower trays frequently, if used regularly.• If a shower has not been used for a while, let it run with hot water before using it.• Keep tiles and grout in good condition.• Clean shower curtains frequently. Common toilet touch points may include:• Keep the U-bend and toilet bowl clean by flushing after each use.• Limescale should be regularly removed using a descaling product.• Keep the toilet seat, handle and rim clean by using a disinfectant.
Cleaning Tools and Equipment	<ul style="list-style-type: none">• Clean tools and equipment before and after each day's work with a disinfectant, concentrating on points of contact such as handles.• Wash your hands after handling tools and equipment to prevent the spread of germs.• If possible, don't share tools on-site. If sharing cannot be prevented, take precautions and follow the hand washing guide before and after each use.
Cleaning Vehicles	<ul style="list-style-type: none">• Have dedicated drivers when using vehicles to avoid the spread of germs.• Don't share vehicles if possible, if you need to use a shared vehicle then wipe down the common touched areas of the vehicle after each use (steering wheel, handbrake, gear stick, dashboard, handles, etc) and wash hands before and after using the vehicle.• Wipe down the inside and common touched areas of the vehicle before and after each day.• Have one person per vehicle where possible. If you are required to have more than one person then keep as much distance between people as possible, open the windows to keep air circulating and passengers to face towards the window to reduce the spread of germs.• If you need to have multiple people in a vehicle, then where possible, split teams into groups and stay in those groups when you travel together.
Cleaning PPE	<ul style="list-style-type: none">• Work clothes to be placed in washing machines and clean reusable PPE.• Read and follow directions on the labels of laundry or clothing and detergent. In general, wash and dry laundry and clothing with the warmest temperatures recommended on the label.• When handling soiled laundry wash your hands afterwards. All clothes and towels should be washed with a laundry product to prevent germs from spreading.• Don't leave laundry in the washing machine – any remaining germs can multiply rapidly.
Specialist Clean	<ul style="list-style-type: none">• If a worker is unwell and removed from site, a specialist clean will be completed in the area/ areas identified where the worker was working and has accessed. These areas are to be isolated until a specialist clean has taken place.• All equipment and vehicles used must be cleaned down and disinfected, concentrating on points of contact such as handles, steering wheels etc.

4.4 SCREENING AND MONITORING PROTOCOL

Construction Sites operating under Coronavirus COVID-19 Lockdown need to ensure they are protecting their workforce and minimising the risk of spread of infection. Screening is a method to assess the possibility of employees and visitors who may have symptoms or have been infected with COVID-19. Rigid screening of employees must take place every day before they enter the workplace. This will be the most effective way to control the spread of the virus within the workplace.

Employees should be screened for COVID-19 related symptoms and report such symptoms to a designated person and / or occupational health practitioner prior to entry into the workplace or work area in order for a decision to be made as to the staff member's continued attendance at work.

During
Screening

- At the start of a workday/shift and prior to ending the workday/shift, designated persons and / or occupational health practitioner must check with employees whether they have experienced sudden onset of any of the following symptoms: cough, shortness of breath or fever/chills (or $\geq 38^{\circ}\text{C}$ measured temperature if this is available at the worksite), in the past 24 hours as outlined in **Daily Symptom Monitoring Tool**.
- If an employee reports any of the above-mentioned symptoms, they should immediately be provided with a FFP1 surgical mask and referred to the designated staff at the workplace so that arrangements can be made for COVID-19 testing at the closest testing centre.
- If employee report any additional symptoms as outlined in the symptom monitoring sheet, s/he should be provided with a surgical mask and referred to the occupational health clinic, family practitioner or primary care clinic for further clinical evaluation and requirement for COVID-19 testing if indicated.
- On receiving their results, the employee and/or health professional supporting the employee should notify their workplace so that the employee is managed accordingly. The workplace should proactively take steps to obtain this information to avoid any delays in reporting.

After isolation
or quarantine
period

- Undergo medical evaluation to confirm that they are fit to work
- Wearing of surgical masks at all times while at work for a period of 21 days from the initial test
- Implement social distancing measures as appropriate (in the case of health workers avoiding contact with severely immunocompromised patients)
- Adherence to hand hygiene, respiratory hygiene, and cough etiquette
- Continued self-monitoring for symptoms, and seek medical re-evaluation if respiratory symptoms recur or worsen

"Appendix C: COVID-19 Daily Symptom Monitoring Tool" is a monitoring Tool to track construction workers on a daily basis for two weeks.

ACRONYMS

PPE	Personal Protective Equipment
WHO	World Health Organization
NICD	National Institute of Communicable Diseases
RR	Residual Risk
OHSA	Occupational Health and Safety Act, 1993 (Act No. 85 of 1993)

KEY TERMS & DEFINITIONS

Contractor	Is defined as a person or company that arranges to supply materials or workers for building or for moving goods.
Extremely Vulnerable Persons	Defined as someone who is solid organ transplant recipients; people with specific cancers: people with cancer who are undergoing active chemotherapy or radical radiotherapy for lung cancer; people with cancers of the blood or bone marrow such as leukaemia, lymphoma or myeloma who are at any stage of treatment; people having immunotherapy or other continuing antibody treatments for cancer; people having other targeted cancer treatments which can affect the immune system, such as protein kinase inhibitors or PARP inhibitors; people who have had bone marrow or stem cell transplants in the last 6 months, or who are still taking immunosuppressive drugs; People with severe respiratory conditions including all cystic fibrosis, severe asthma and severe COPD; People with rare diseases and inborn errors of metabolism that significantly increase the risk of infections (such as SCID, homozygous sickle cell); People on immunosuppression therapies sufficient to significantly increase risk of infection; Women who are pregnant with significant heart disease, congenital or acquired.)
Physical Distancing	Physical distancing, also known as “social distancing”, is about keeping a safe distance from others.
Safe Work Practices	Safe work practices are types of administrative controls that include procedures for safe and proper work used to reduce the duration, frequency, or intensity of exposure to a hazard.
Screening	Screening is a way for health workers to find out if you may have COVID-19 or not. The health worker will ask you questions and scan your forehead to take your temperature.
Workplace	Workplace means any premises or place where a person performs work.

APPENDIX A: SAFE PRACTICES ON SITE

Using Face Masks on Site



Wash Hands First

Always make sure you wash your hands thoroughly before and after touching a mask.



Masks

There are many kinds of masks, depending on the task.



The Right Side

There is a metal clip at the top of the mask.



Placement

Place the metal clip across the top of your nose.



Attach the Mask

Attach the mask by pulling the elastic bands over your ears.



Stretch Down

Stretch the mask down, so that it covers your chin.



Adjust

Bend the metal clip around your nose so that it sits securely.



Taking off the Mask

Pull the elastic bands away from your ears.



Disposal

Always place the used mask in a closed rubbish bin for secure disposal.

Using Face Masks on Site



Any time you are completing a manual task

Use your usual work safety gloves



If you are cleaning any surfaces

Use disposable gloves for this and throw them in the bin when you finish cleaning



Avoid touching your face while wearing gloves



Remove your gloves and then wash your hands prior to eating, drinking or smoking/vaping



Practice good hand hygiene and good cough and sneeze etiquette while wearing gloves

APPENDIX B: SUSPECTED OR CONFIRMED CASE OF COVID-19

If the suspected or confirmed case of COVID-19 is at work



Isolate

Isolate the person from others and provide a disposable surgical mask, if available, for the person to wear.



Inform

Call (Insert No). Follow the advice of health officials.



Transport

Ensure the person has transport to their home or to a medical facility



Clean

Clean the area where the person was working and all places they have been. This may mean evacuating those areas. Use PPE when cleaning. Identify who at the workplace had close contact with the infected person in the 24 hours before that infected person started showing symptoms. Send those people home to isolate. Allow employees to raise concerns.



Identify



Clean

Clean the area where the person was working and all places they have been. This may mean evacuating those areas. Use PPE when cleaning. Review risk management controls relating to COVID-19 and review whether work may need to change. Keep employees up to date on what is happening.



Review

If the suspected or confirmed case of COVID-19 is not at work when diagnosed



Inform

Call (Insert No). Follow the advice of health officials.



Identify

Identify who at the workplace had close contact with the infected person in the 24 hours before that infected person started showing symptoms. Send those people home to isolate. Allow employees to raise concerns. Clean the area where the person was working and all places they have been. This may mean evacuating those areas. Use PPE when cleaning.



Clean



Review

Review risk management controls relating to COVID-19 and review whether work may need to change. Keep employees up to date on what is happening.

APPENDIX C: COVID-19 DAILY SYMPTOM MONITORING TOOL



COVID-19 DAILY SYMPTOM MONITORING TOOL

Details of Worker				Details of Person completing this form		Date completing form	
Identifier	Date of contact	DD/MM/YYYY	Place last contact	Surname	Name	DD/MM/YYYY	
Surname	Name			Role	Facility name		
Date of birth	DD/MM/YYYY	Age (Y)	Sex M <input type="checkbox"/> F <input type="checkbox"/>	Email address	Telephone number		
Healthcare worker	Y <input type="checkbox"/> N <input type="checkbox"/> If yes, facility name			Next of kin details			
Contact number(s)	Email			Next of Kin name and surname	Next of Kin contact number		
Physical address							
House number	Street			Suburb	Town		
District	Province			Patient traced	Y <input type="checkbox"/> N <input type="checkbox"/>		
Details of confirmed COVID-19 case (Complete only if Applicable)							
Contact type ¹	Close <input type="checkbox"/> Casual <input type="checkbox"/>	Relationship		Name	Surname	Date of Birth DD/MM/YYYY	

Instructions for completion: Mark "Y" if symptom present and "N" if not. If any symptoms are present collect, contact (Insert No) immediately and make immediate arrangements for the collection of a combined nasopharyngeal and oropharyngeal swab. Refer to COVID-19 Quick Guide on the NICD website for additional details. Days post exposure to case.

DAY	1	2	3	4	5	6	7	8	9	10	11	12	13	14
Date (DD/MM)														
Measured body temp														
Chills	<input type="checkbox"/> Y <input type="checkbox"/> N	<input type="checkbox"/> Y <input type="checkbox"/> N	<input type="checkbox"/> Y <input type="checkbox"/> N	<input type="checkbox"/> Y <input type="checkbox"/> N	<input type="checkbox"/> Y <input type="checkbox"/> N	<input type="checkbox"/> Y <input type="checkbox"/> N	<input type="checkbox"/> Y <input type="checkbox"/> N	<input type="checkbox"/> Y <input type="checkbox"/> N	<input type="checkbox"/> Y <input type="checkbox"/> N	<input type="checkbox"/> Y <input type="checkbox"/> N	<input type="checkbox"/> Y <input type="checkbox"/> N	<input type="checkbox"/> Y <input type="checkbox"/> N	<input type="checkbox"/> Y <input type="checkbox"/> N	<input type="checkbox"/> Y <input type="checkbox"/> N
Cough	<input type="checkbox"/> Y <input type="checkbox"/> N	<input type="checkbox"/> Y <input type="checkbox"/> N	<input type="checkbox"/> Y <input type="checkbox"/> N	<input type="checkbox"/> Y <input type="checkbox"/> N	<input type="checkbox"/> Y <input type="checkbox"/> N	<input type="checkbox"/> Y <input type="checkbox"/> N	<input type="checkbox"/> Y <input type="checkbox"/> N	<input type="checkbox"/> Y <input type="checkbox"/> N	<input type="checkbox"/> Y <input type="checkbox"/> N	<input type="checkbox"/> Y <input type="checkbox"/> N	<input type="checkbox"/> Y <input type="checkbox"/> N	<input type="checkbox"/> Y <input type="checkbox"/> N	<input type="checkbox"/> Y <input type="checkbox"/> N	<input type="checkbox"/> Y <input type="checkbox"/> N
Sore throat	<input type="checkbox"/> Y <input type="checkbox"/> N	<input type="checkbox"/> Y <input type="checkbox"/> N	<input type="checkbox"/> Y <input type="checkbox"/> N	<input type="checkbox"/> Y <input type="checkbox"/> N	<input type="checkbox"/> Y <input type="checkbox"/> N	<input type="checkbox"/> Y <input type="checkbox"/> N	<input type="checkbox"/> Y <input type="checkbox"/> N	<input type="checkbox"/> Y <input type="checkbox"/> N	<input type="checkbox"/> Y <input type="checkbox"/> N	<input type="checkbox"/> Y <input type="checkbox"/> N	<input type="checkbox"/> Y <input type="checkbox"/> N	<input type="checkbox"/> Y <input type="checkbox"/> N	<input type="checkbox"/> Y <input type="checkbox"/> N	<input type="checkbox"/> Y <input type="checkbox"/> N
Shortness of breath	<input type="checkbox"/> Y <input type="checkbox"/> N	<input type="checkbox"/> Y <input type="checkbox"/> N	<input type="checkbox"/> Y <input type="checkbox"/> N	<input type="checkbox"/> Y <input type="checkbox"/> N	<input type="checkbox"/> Y <input type="checkbox"/> N	<input type="checkbox"/> Y <input type="checkbox"/> N	<input type="checkbox"/> Y <input type="checkbox"/> N	<input type="checkbox"/> Y <input type="checkbox"/> N	<input type="checkbox"/> Y <input type="checkbox"/> N	<input type="checkbox"/> Y <input type="checkbox"/> N	<input type="checkbox"/> Y <input type="checkbox"/> N	<input type="checkbox"/> Y <input type="checkbox"/> N	<input type="checkbox"/> Y <input type="checkbox"/> N	<input type="checkbox"/> Y <input type="checkbox"/> N
Myalgia/body pains	<input type="checkbox"/> Y <input type="checkbox"/> N	<input type="checkbox"/> Y <input type="checkbox"/> N	<input type="checkbox"/> Y <input type="checkbox"/> N	<input type="checkbox"/> Y <input type="checkbox"/> N	<input type="checkbox"/> Y <input type="checkbox"/> N	<input type="checkbox"/> Y <input type="checkbox"/> N	<input type="checkbox"/> Y <input type="checkbox"/> N	<input type="checkbox"/> Y <input type="checkbox"/> N	<input type="checkbox"/> Y <input type="checkbox"/> N	<input type="checkbox"/> Y <input type="checkbox"/> N	<input type="checkbox"/> Y <input type="checkbox"/> N	<input type="checkbox"/> Y <input type="checkbox"/> N	<input type="checkbox"/> Y <input type="checkbox"/> N	<input type="checkbox"/> Y <input type="checkbox"/> N
Diarrhoea ³	<input type="checkbox"/> Y <input type="checkbox"/> N	<input type="checkbox"/> Y <input type="checkbox"/> N	<input type="checkbox"/> Y <input type="checkbox"/> N	<input type="checkbox"/> Y <input type="checkbox"/> N	<input type="checkbox"/> Y <input type="checkbox"/> N	<input type="checkbox"/> Y <input type="checkbox"/> N	<input type="checkbox"/> Y <input type="checkbox"/> N	<input type="checkbox"/> Y <input type="checkbox"/> N	<input type="checkbox"/> Y <input type="checkbox"/> N	<input type="checkbox"/> Y <input type="checkbox"/> N	<input type="checkbox"/> Y <input type="checkbox"/> N	<input type="checkbox"/> Y <input type="checkbox"/> N	<input type="checkbox"/> Y <input type="checkbox"/> N	<input type="checkbox"/> Y <input type="checkbox"/> N

¹ Close contact: A person having had face-to-face contact (≤2 metres) or was in a closed environment with a COVID-19 case; this includes, amongst others, all persons living in the same household as a COVID-19 case and, people working closely in the same environment as a case. A healthcare worker or other person providing direct care for a COVID-19 case, while not wearing recommended personal protective equipment or PPE (e.g., gowns, gloves, NIOSH-certified disposable N95 respirator, eye protection). A contact in an aircraft sitting within two seats (in any direction) of the COVID-19 case, travel companions or persons providing care, and crew members serving in the section of the aircraft where the index case was seated. Casual contact: Anyone not meeting the definition for a close contact but with possible exposure. ² Chose from: Spouse, Aunt, Child, Class mate, Colleague, Cousin, Father, Friend, Grandfather, Grandmother, Healthcare worker taking care of, Mother, Nephew, Niece, Other relative, Uncle. ³ Diarrhoea defined as three or more loose stools in a 24-hour period.

APPENDIX D: COVID-19 BASELINE RISK ASSESSMENT

					Likelihood				
					Very Unlikely	Unlikely	Possible	Likely	Very Likely
Severity	Negligible				1	2	3	4	5
	Minor				2	4	6	8	10
	Moderate				3	6	9	12	15
	Major				4	8	12	16	20
	Extreme				5	10	15	20	25
Hazard	L	S	Risk	Control Measures	L	S	RR	Persons at Risk	
Exposure from others due to: 1. Living with someone with a confirmed case of COVID-19. 2. Have come into close contact (within 2 metres for 15 minutes or more) with a confirmed case of COVID-19. 3. Being advised by a public health authority that contact with a diagnosed case has occurred.				<ul style="list-style-type: none"> To follow government action of self-isolation and only to leave house on the following circumstances: for medical reason; to shop for necessary food supplies; for exercise once per day; and for essential works including those deemed 'key workers' Any existing individual risk assessments (disability, young persons or new / expectant mothers) to be reviewed Maintain contact with line management and Human Resources (HR) and to follow company policy / guidance. Travel is only required for essential travel; reduce the amount of time using public transport and to implement social distancing where possible (2m clearance from persons and not to travel in groups of more than 2 unless it is immediate family) To continue following ongoing government guidance Stay at home and only attend hospital in an emergency. Do not attend GP surgery and phone (Insert No) if further advice is required Company to ensure extremely vulnerable persons are shielding themselves and following their specific medical advice issued to them no later than 29/3/2020 Always follow good hygiene measures Avoid all visitors to your home unless they are providing a medical requirement Do not approach delivery staff, allow packages to be left on the doorstep Do not take any antibiotics as they do not work against viruses. 				Individual Workers	
Suspected case whilst working on site				If a worker develops a high temperature or a persistent cough while at work, they should: 1. Return home immediately				Individual workers	

					Likelihood						
					Very Unlikely	Unlikely	Possible	Likely	Very Likely		
					Severity	Negligible	1	2	3	4	5
						Minor	2	4	6	8	10
						Moderate	3	6	9	12	15
						Major	4	8	12	16	20
						Extreme	5	10	15	20	25
Hazard	L	S	Risk	Control Measures	L	S	RR	Persons at Risk			
				<ol style="list-style-type: none"> 2. Avoid touching anything 3. Cough or sneeze into a tissue and put it in a bin, or if they do not have tissues, cough and sneeze into the crook of their elbow. 4. They must then follow the guidance on self-isolation and not return to work until their period of self-isolation has been completed. 							
General travel including foreign travel				<ol style="list-style-type: none"> 1. Do not travel unless you cannot work from home or deemed a key worker – implement teleconferencing for meetings 2. Where an individual has recently visited these countries, they should self / home isolate themselves until further notice from the government (lockdown measures continue to apply) 3. Please continue to follow any further national government advice provided 4. Where an occupational health (OH) service provider has been appointed, please seek additional advice or concerns through this service 5. All persons to limit their use of public transport. Where travel is essential, please use private single occupancy where possible 				Individual workers			
Access / egress to site				<p>Where possible, please consider and implement the following practices:</p> <ol style="list-style-type: none"> 1. Stop all non-essential visitors 2. Introduce staggered start and finish times to reduce congestion and contact at all times 3. Monitor site access points to enable social distancing – you may need to change the number of access points, either increase to reduce congestion or decrease to enable monitoring 4. Remove or disable entry systems that require skin contact e.g. fingerprint scanners 5. Require all workers to wash or clean their hands before entering or leaving the site 6. Allow plenty of space (two metres) between people waiting to enter site 				Individual workers			

					Likelihood						
					Very Unlikely	Unlikely	Possible	Likely	Very Likely		
					Severity	Negligible	1	2	3	4	5
						Minor	2	4	6	8	10
						Moderate	3	6	9	12	15
						Major	4	8	12	16	20
						Extreme	5	10	15	20	25
Hazard	L	S	Risk	Control Measures	L	S	RR	Persons at Risk			
				<ol style="list-style-type: none"> 7. Regularly clean common contact surfaces in reception, office, access control and delivery areas e.g. scanners, turnstiles, screens, telephone handsets, desks, particularly during peak flow times 8. Reduce the number of people in attendance at site inductions and consider holding them outdoors wherever possible 9. Drivers should remain in their vehicles if the load will allow it and must wash or clean their hands before unloading goods and materials. 							
Inclement weather – cold temperature allows disease to survive				<ol style="list-style-type: none"> 1. All persons to dress appropriately for the weather 2. Welfare facilities provided to shelter from the elements 3. Maintain good hygiene measures at all times 4. Appropriate respiratory protective equipment (RPE) masks to be considered as last resort however face fit test (FFT) must be completed to ensure mask effectiveness. It is advised to speak to your H&S competent person on these matters and supplies should be reserved for medical staff as it has been documented that supplies have been difficult to procure 				Individual workers			
Poor hygiene				<ol style="list-style-type: none"> 1. Wash your hands thoroughly and regularly. Use soap and water for at least 20 seconds. Use alcohol-based hand sanitiser if soap and water is not available and hand washing technique to be adopted as directed 2. Avoid touching your face/eyes/nose/mouth with unwashed hands and cover your cough or sneeze with a tissue then throw it in the bin. 3. Provide additional hand washing facilities to the usual welfare facilities if a large spread out site or significant numbers of personnel on site 4. Regularly clean the hand washing facilities and check soap and sanitiser levels 5. Provide suitable and sufficient rubbish bins for hand towels with regular removal and disposal. 6. Sites will need extra supplies of soap, hand sanitiser and paper towels and these should be securely stored. 				Individual workers			

					Likelihood						
					Very Unlikely	Unlikely	Possible	Likely	Very Likely		
					Severity	Negligible	1	2	3	4	5
						Minor	2	4	6	8	10
						Moderate	3	6	9	12	15
						Major	4	8	12	16	20
						Extreme	5	10	15	20	25
Hazard	L	S	Risk	Control Measures	L	S	RR	Persons at Risk			
				7. Restrict the number of people using toilet facilities at any one time e.g. use a welfare attendant. Wash hands before and after using the facilities. Enhance the cleaning regimes for toilet facilities particularly door handles, locks and the toilet flush. Portable toilets should be avoided wherever possible, but where in use these should be cleaned and emptied more frequently.							
Canteen - exposure from large numbers of persons				<ol style="list-style-type: none"> 1. The workforce should also be required to stay on site once they have entered it and not use local shops. 2. Dedicated eating areas should be identified on site to reduce food waste and contamination 3. Break times should be staggered to reduce congestion and contact at all times 4. Hand cleaning facilities or hand sanitiser should be available at the entrance of any room where people eat and should be used by workers when entering and leaving the area 5. The workforce should be asked to bring pre-prepared meals and refillable drinking bottles from home 6. Workers should sit 2 metres apart from each other whilst eating and avoid all contact 7. Where catering is provided on site, it should provide pre-prepared and wrapped food only - Payments should be taken by contactless card wherever possible and Crockery, eating utensils, cups etc. should not be used 8. Drinking water should be provided with enhanced cleaning measures of the tap mechanism introduced 9. Tables should be cleaned between each use 10. All rubbish should be put straight in the bin and not left for someone else to clear up 11. All areas used for eating must be thoroughly cleaned at the end of each break and shift, including chairs, door handles, vending machines and payment devices. 				Individual Workers			

					Likelihood				
					Very Unlikely	Unlikely	Possible	Likely	Very Likely
Severity	Negligible				1	2	3	4	5
	Minor				2	4	6	8	10
	Moderate				3	6	9	12	15
	Major				4	8	12	16	20
	Extreme				5	10	15	20	25
Hazard	L	S	Risk	Control Measures	L	S	RR	Persons at Risk	
Use of Changing facilities, showers and drying rooms				<ol style="list-style-type: none"> 1. Introduce staggered start and finish times to reduce congestion and contact at all times 2. Introduce enhanced cleaning of all facilities throughout the day and at the end of each day 3. Consider increasing the number or size of facilities available on site if possible 4. Based on the size of each facility, determine how many people can use it at any one time to maintain a distance of two metres 5. Provide suitable and sufficient rubbish bins in these areas with regular removal and disposal. 				Individual workers	